



## NEC Storage Software

# Virtual Volume User's Manual



© NEC Corporation 2015-2018

No part of the contents of this book may be reproduced or transmitted in any form without permission of NEC Corporation.

The contents of this book may be modified without notice in the future.

# Preface

---

This manual describes how to use the NEC Storage Virtual Volume function.

The NEC Storage Virtual Volume function consists of the VASA Provider and the software for setting and browsing the information about the Virtual Volume function. This function implements the “Virtual Volumes” function that is provided by VMware vSphere 6.0 or later on the NEC Storage disk array. For details about VMware vSphere Virtual Volumes, refer to the documentation provided by VMware, Inc.

Refer to the following manuals as well.

- Overview of the NEC Storage series disk arrays and related manuals  
NEC Storage Manager Manual Guide (IS901)
- Overview and operation methods of NEC Storage Manager (including NEC Storage Manager Express)  
NEC Storage Manager User’s Manual (IS050)  
NEC Storage Manager Command Reference (IS052)

Remarks 1. This manual explains functions implemented by the following program products:

- NEC Storage Manager Suite
  - NEC Storage BaseProduct
  - NEC Storage VASA Provider
2. This manual is applicable to the program products of the following versions:
- NEC Storage Manager Suite Ver10.1 or later
  - NEC Storage BaseProduct Ver9.7 or later
  - NEC Storage VASA Provider Ver2.5.001 or later
3. The NEC Storage Manager is referred to as iSM or Storage Manager in this manual unless clearly specified.

Also, the following terms refer to the corresponding software products.

Term	Product
VASA Provider	NEC Storage VASA Provider
DynamicDataReplication or DDR	NEC Storage DynamicDataReplication
DynamicSnapVolume	NEC Storage DynamicSnapVolume
vSphere	VMware vSphere
vCenter	VMware vCenter Server
vSphere Web Client	VMware vSphere Web Client

4. The NEC series disk array subsystem is referred to as a disk array in this manual unless clearly specified.

Also, the following terms refer to the corresponding NEC Storage hardware products.

Term	NEC Storage Hardware Product
M series	NEC Storage M series

5. The following terms in this manual refer to the NEC Storage software manuals.

Term	NEC Storage Software Manual
Performance Monitoring User's Manual	NEC Storage Software Performance Monitoring User's Manual (IS025)
Performance Analysis User's Manual	NEC Storage Software Performance Analysis User's Manual (IS029)
User's Manual	NEC Storage Software User's Manual (IS050)
Configuration Setting Tool User's Manual (GUI) for the M Series	NEC Storage Software Configuration Setting Tool User's Manual (GUI) for the M Series (IS051)
Command Reference	NEC Storage Software NEC Storage Manager Command Reference (IS052)
Data Allocation Optimization User's Manual	NEC Storage Software Data Allocation Optimization User's Manual (IS061)
L2 Cache User's Manual	NEC Storage Software L2 Cache User's Manual (IS062)
I/O Control User's Manual	NEC Storage Software I/O Control User's Manual (IS067)

6. Trademarks and registered trademarks

- Microsoft, Windows, Windows Server, Windows Vista, and Hyper-V are trademarks or registered trademarks of Microsoft Corporation in the United States and other countries.
- HP-UX is a registered trademark of Hewlett-Packard Co. in the United States.
- UNIX is a registered trademark of The Open Group in the United States and other countries.
- VERITAS, VxVM, VxFS, NetBackup, VERITAS Volume Manager, VERITAS File System, and VERITAS NetBackup are trademarks or registered trademarks of Symantec Corporation in the United States and other countries.
- Oracle and Solaris are registered trademarks of Oracle Corporation and/or its affiliates in the United States and other countries.
- Linux is a trademark or registered trademark of Mr. Linus Torvalds in the United States and other countries.
- VMware, VMware vSphere, and VMware vSphere ESXi are trademarks or registered trademarks of VMware, Inc. in the United States and other countries.

Other product names and company names, etc. are trademarks or registered trademarks of the associated companies.

7. This product includes the OSSs below. For details on the licenses, refer to Appendix A of this manual.



- Apache log4j (<http://logging.apache.org/>)
- Apache Tomcat (<http://tomcat.apache.org/>)
- OpenSSL (<http://www.openssl.org/>)
- Ganymed SSH-2 for Java (<http://www.cleondris.ch/opensource/ssh2/>)
- The Legion of the Bouncy Castle (<http://www.bouncycastle.org>)
- Apache Axis (<http://axis.apache.org/>)

8. In this document, the capacity is calculated based on units of 1024 (for example 1 KB = 1024 bytes) unless otherwise specified.

9. In this document, matters to which careful attention needs to be paid will be described as follows:

Be sure to observe the instructions.

If the indications are ignored and the system is improperly operated, settings which have already been made might be affected.

Type of Indication	
Type	Description
	Describes contents which require users to pay special attention for operation.
	Describes information about restrictions on operation.

1st Edition in October 2015

6th Edition in July 2018

# Contents

---

<b>Chapter 1</b>	<b>Overview of Virtual Volume</b>	<b>1</b>
1.1	Virtual Volume	1
1.2	Differences from the Conventional vSphere Environment	2
1.3	System Configuration	3
<b>Chapter 2</b>	<b>Setup</b>	<b>4</b>
2.1	Setting up a Disk Array	4
2.1.1	Unlocking the License	4
2.1.2	Creating and Deleting a Storage Container	5
2.1.3	Creating and Deleting a Solution Reserved Volume	6
2.1.4	Creating and Deleting a Protocol Endpoint	10
2.1.5	Creating and Deleting a Snapshot Reserve Area	13
2.2	Setting up VASA Provider	18
2.2.1	Installing VASA Provider	18
2.2.2	Registering VASA Provider in vCenter Server	24
2.3	Maintenance of VASA Provider	25
2.3.1	Modification of Settings	25
2.3.2	Uninstallation	29
<b>Chapter 3</b>	<b>Basic Operations</b>	<b>30</b>
3.1	Configuration Management	30
3.1.1	Displaying VVOL-Related Resources on the iSM Client Screen	30
3.1.2	Displaying VVOL-Related Resources by Using the Configuration Display Command	42
3.1.3	Displaying VVOL-Related Resources on the vSphere Web Client	46
3.2	Adding and Deleting a Datastore	50
3.2.1	Adding a Datastore	50
3.2.2	Deleting a Datastore	51
3.3	Adding and Deleting a Virtual Machine	52
3.3.1	Adding a Virtual Machine	52
3.3.2	Deleting a Virtual Machine	52
3.4	Adding and Deleting a Server	53
3.4.1	Adding a Server	53
3.4.2	Deleting a Server	53
3.5	Expanding the Capacity of a Disk Array	54
3.6	Migrating a Virtual Machine	56
3.7	Creating and Deleting a Snapshot of a Virtual Machine	57
3.7.1	Using the Snapshot Function	57
3.7.2	Creating a Snapshot of a Virtual Machine	59

3.7.3	Deleting a Snapshot of a Virtual Machine .....	59
3.8	Creating a Clone of a Virtual Machine .....	60
3.8.1	Using the Volume Clone Function .....	60
3.8.2	Creating a Clone of a Virtual Machine.....	61
3.9	Policy-Based Allocation.....	62
3.9.1	Defining a Backup Policy.....	64
3.9.2	Defining an I/O Control Policy .....	68
3.9.3	Assigning a Storage Policy to a Virtual Machine .....	69
3.10	Adding a Storage Device.....	70
<b>Chapter 4</b>	<b>VVOL Operation Using Storage Functions .....</b>	<b>71</b>
4.1	Backup Operation.....	71
4.2	I/O Control Function .....	73
4.3	L2 Cache Function .....	75
4.4	Data Allocation Optimization Function .....	76
4.5	Performance Monitoring Function and Performance Analysis Function.....	77
<b>Chapter 5</b>	<b>Troubleshooting.....</b>	<b>78</b>
5.1	Collecting Logs .....	78
5.2	Troubleshooting.....	79
<b>Appendix A</b>	<b>Notes.....</b>	<b>82</b>
A.1	Notes.....	82
A.2	Deletion of Unnecessary VVOLs .....	85
<b>Appendix B</b>	<b>Messages .....</b>	<b>93</b>
B.1	Messages .....	93
<b>Appendix C</b>	<b>Files .....</b>	<b>107</b>
C.1	Configuration File .....	107
<b>Appendix D</b>	<b>Setting up the Management Memory of the Extended Snapshot Function .....</b>	<b>110</b>
<b>Appendix E</b>	<b>Backup Operations and Messages.....</b>	<b>112</b>
E.1	Backup Operations .....	112
E.1.1	onlineBackup.bat .....	112
E.1.2	VM-VVOLRelation.bat .....	113
E.2	Messages .....	116
<b>Appendix F</b>	<b>Virtual Volume Management Screen .....</b>	<b>122</b>
F.1	Installation and Setup Procedure.....	122
F.2	Virtual Volume VM List Screen .....	123
F.2.1	Batch Backup.....	125

F.3	Virtual Volume VM Backup Information Screen .....	128
F.3.1	Backing up a VM.....	131
F.3.2	Cancelling a Backup.....	134
F.3.3	Restoring a Backup.....	137
F.3.4	Generating a Backup Script.....	141
F.3.5	Identifying the Cause of a Logical Disk Failure by using the iSM Client .....	143
F.4	Virtual Volume Information Screen.....	145
<b>Appendix G</b>	<b>License .....</b>	<b>149</b>
G.1	Apache log4j, Apache Commons Logging, Apache Tomcat .....	149
G.2	Ganymed SSH-2 for Java License.....	154
G.3	The Legion of the Bouncy Castle.....	156
<b>Index</b> .....		<b>157</b>



# Chapter 1 Overview of Virtual Volume

This chapter describes the Virtual Volume function, including the functional features, difference from the conventional vSphere environment, and system configuration.

## 1.1 Virtual Volume

The Virtual Volume function enables M series disk arrays to link with VMware vSphere so that the disks (virtual disks) on the virtual machines (VMs) running on a vSphere ESXi host can be managed on the disk arrays. This makes it possible to set and operate each function that disk arrays have for each virtual machine.

In the conventional vSphere environment, multiple virtual machines exist in one LUN. The I/O control function provided by the M series operates in LUN units, so it was not possible to perform I/O control in virtual machine units. The Virtual Volume function enables the storage to manage a virtual disk, controlling the flow of each virtual machine with the I/O control function of the M series. A virtual disk managed by the storage is referred to as a VVOL.

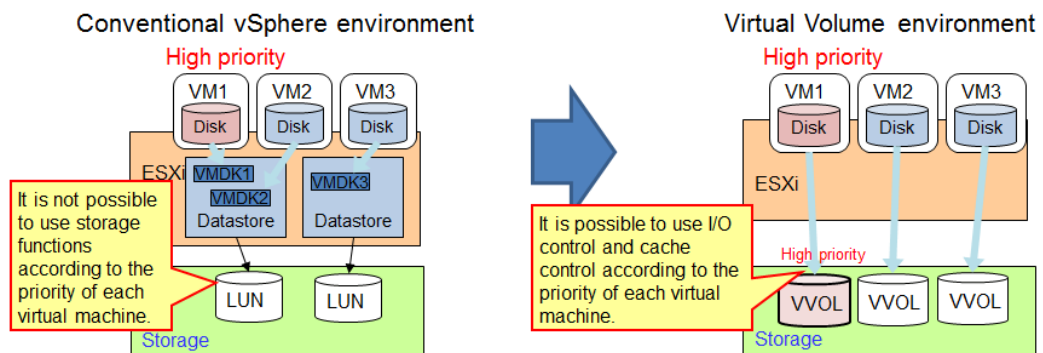

Figure 1-1 Overview of the Virtual Volume Function

## 1.2 Differences from the Conventional vSphere Environment

---

In the conventional vSphere environment, an ESXi host uses a logical disk on an M series disk array as a datastore. An ESXi host creates a VMFS file system on the datastore, and creates a virtual disk as a file (VMDK file) on VMFS. Thus, a single logical disk can be used by multiple virtual machines. In this manual, this environment is called a “VMFS environment.”

In a Virtual Volume environment, on the other hand, the actual objects of the virtual disks allocated to virtual machines are logical disks managed on disk arrays. If virtual machines and virtual disks are created with vSphere functions, logical disks with Virtual Volume (VVOL) attributes are automatically created on disk arrays. These logical disks are allocated to the virtual machines. If virtual disks are created in VMFS datastores, they are created as conventional VMDK files. If virtual disks are created in VVOL datastores, they are created as VVOLS.

A VVOL datastore is a disk array pool.

Regardless of whether a virtual disk is created as a VVOL or a VMDK file, it can be operated on vSphere in the same way. For example, in the case of a VVOL, if a VM snapshot is to be created on a vSphere virtual machine, a Snapshot is created using a disk array unit function. Restore and other operations can also be performed from vSphere.

Table 1-1 Differences between Virtual Volume Environment and VMFS Environment

	VMFS environment	VVOL environment	Remarks
Virtual disk	VMDK file	Logical disk	
Datastore	Logical disk	Pool	Referred to as a Storage Container in a Virtual Volume environment
Snapshot	Achieved with a function on VMFS on the ESXi host	Achieved with a storage function	
Operations on a virtual disk	Performed from vSphere	Performed from vSphere	Operations can be performed in both Virtual Volume and VMFS environments in the same way.

## 1.3 System Configuration

A Virtual Volume (VVOL) datastore in a Virtual Volume environment is a disk array pool. A pool that becomes a Virtual Volume datastore is called a Storage Container.

In a Virtual Volume environment, a Virtual Volume is not accessed directly from an ESXi host but is accessed via a special logical disk called a Protocol Endpoint (PE).

In a Virtual Volume environment, VASA Provider must run on the management server. VASA Provider is operating between the ESXi host and the disk array, automatically creating VVOLs and connecting to a PE during, for example, VM creation.

Table 1-2 Terms Used in a Virtual Volume Environment

Term	Abbreviation	Description
Virtual Volume	VVOL	Virtual volume managed by a disk array. The entity of a virtual disk on a virtual machine is VVOL.
Storage Container	SC	Pool for a Virtual Volume
Protocol Endpoint	PE	Logical disk to be used as an access point from an ESXi host to VVOL

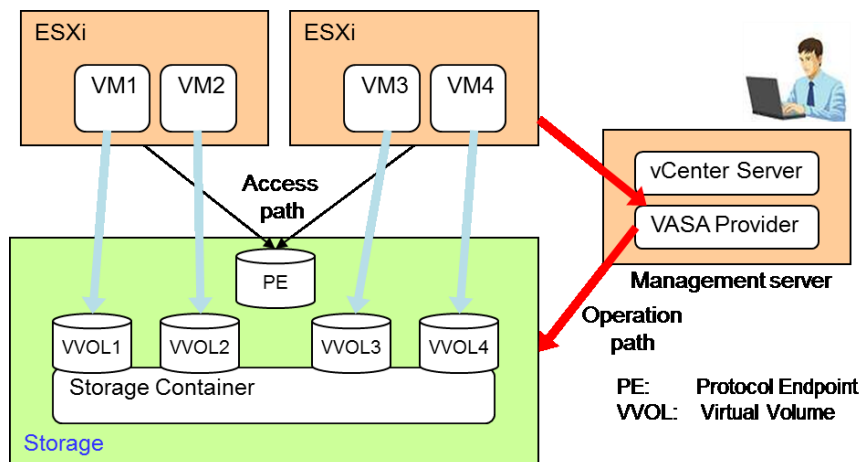

Figure 1-2 System Configuration in a Virtual Volume Environment

## Chapter 2 Setup

Before using the Virtual Volume function, it is necessary to set up a disk array and VASA Provider.

This chapter describes the procedures to setup a disk array and VASA Provider.

### 2.1 Setting up a Disk Array

---

#### 2.1.1 Unlocking the License

---

Unlock the Virtual Volume license from iSM. In a Virtual Volume (VVOL) environment, it is possible to create virtual machine snapshots and clones by using the functions provided by the disk array. The DynamicSnapVolume license must have been unlocked to create a virtual machine snapshot. The VolumeClone license must have been unlocked to create a virtual machine link clone. Unlocking the DynamicDataReplication license allows you to create a virtual machine clone by using a disk array function, reducing the load on the server.

For more information about how to unlock the licenses, refer to the “Configuration Setting Tool User’s Manual (GUI) for the M Series” or the section “iSMcfg license release” in the “Command Reference.”

## 2.1.2 Creating and Deleting a Storage Container

Create a Storage Container that will be used as a VVOL datastore. A Storage Container is created as a virtual capacity pool. When creating a pool, use an option to specify it as a Storage Container.

### Execution example 1: Create a Storage Container on the iSM client screen.

When creating a Storage Container on the iSM client screen, select both [Create a virtual capacity pool] and [Create as a storage container] on the Create Pool screen.

Figure 2-1 Storage Container Creation Screen of the iSM Client

For more information about the iSM client, refer to “Create Pool” in the “Configuration Setting Tool User’s Manual (GUI) for the M Series.”

### Execution example 2: Create a Storage Container by using the `iSMcfg` command.

```
# iSMcfg poolbind -type virtual -poolnumber 0001h -poolname pool0 -raid 1 -pdg
00h -pdn 0000h-0001h -capacity 20 -unit tb -sc
```

For more information about the `iSMcfg poolbind` command, refer to the section “iSMcfg poolbind” in the “Command Reference.”



- It is not possible to convert an existing pool into a Storage Container.
- For load balancing, it is recommended to create multiple Storage Containers in one disk array so that even pool numbers and odd pool numbers are the same in number.

To delete the created Storage Container, connect the server to the disk array and execute the following command. For *POOL\_Number* or *POOL\_Name*, specify the number or name of the created Storage Container.

### [ Syntax ]

```
iSMcfg poolunbind {-poolnumber POOL_Number | -poolname POOL_Name }
```

### Execution example 3: Delete a Storage Container by using the `iSMcfg` command.

```
iSMcfg poolunbind -poolnumber 0001h
```

For more information about the `iSMcfg poolunbind` command, refer to the section “`iSMcfg poolunbind`” in the “Command Reference.”

Before deleting the Storage Container, all logical disks created in the target Storage Container must be deleted.

## 2.1.3 Creating and Deleting a Solution Reserved Volume

---

With a solution reserved volume (SSV) created in a VVOL environment, snapshots or clones of virtual machine can be created by using disk array functions.

To create an SSV, either a Storage Container or a normal pool can be specified as the pool in which to create the SSV.



Note the following when creating an SSV:

- An SSV can also be created on a virtual capacity pool that uses the ThinProvisioning function, but immediately after it is created, a physical capacity is allocated to the entire area of the SSV. Therefore, it will not be a virtual capacity logical disk.
- The capacity of an SSV is fixed to 4 GB. Make sure that there is 4 GB or more free space before creating an SSV.

### 2.1.3.1 Creating a Solution Reserved Volume on the iSM Client Screen

Select [Solution Reserved Volume] on the Create Logical Disk (System / Control Volume) screen of the iSM client.

Create Logical Disk (System/Control Volumes)

Create Logical Disk (System / Control Volume) > Confirmation > Completion

1. Select the Pool to create the Logical Disk.

Show all pools

- Pool list -

Number	Pool name	RAID	Physical disk type	Free capacity[GB]	Capacity[GB]	Actual
0100a	testpool	RAID1/10	MLAS	1808.7	1817.0	

Show logical disks of the selected pool

2. Select the type of System / Control Volume to create

Control volume (0.2GB)  
Number of logical disks

Protocol Endpoint (0.1GB)  
Number of logical disks

System volume (8.0GB)

Replication reserved volume (8.0GB)

Data migration reserved volume (14.0GB)

Solution reserved volume (4.0GB)

Logical disk capacity : 0.2 GB  
Capacity logical disks consume : 0.2 GB  
Unused capacity of the pool : 1,808.7 GB

3. Set logical disk name.

Logical disk name

Explanation  
If multiple Logical Disks are created, the same Logical Disk name will be used as a prefix followed by ascending numbers.

4. Set the Block Size of logical disk.

Block Size  byte

< Back Next > Cancel Help

Figure 2-2 Solution Reserved Volume Creation Screen of the iSM Client

For details of the iSM client, refer to “Create Logical Disk (System/Control Volume)” in the “Configuration Setting Tool User’s Manual (GUI) for the M Series.”

### 2.1.3.2 Creating a Solution Reserved Volume by Using the iSMcfg Command

---

#### [ Syntax ]

```
iSMcfg ldbind {-poolnumber POOL_Number | -poolname POOL_Name }  
              [-ldn LD_Number] -ldattr ssv
```

For *POOL\_Number* or *POOL\_Name*, specify the number or name of the SSV to be created.

For *LD\_Number*, specify the LD number of an SSV.

#### Execution example: Create an SSV in a pool whose number is 0001h.

```
iSMcfg ldbind -poolnumber 0001h -ldattr ssv
```

For more information about the `iSMcfg ldbind` command, refer to the section “iSMcfg ldbind” in the “Command Reference.”

To create an SSV, the following conditions must be met. If your attempt to create an SSV fails, check whether the following conditions are met:

- Only a single SSV can be created in a disk array.
- To create an SSV, the VolumeClone or DynamicSnapVolume must have been unlocked. Also, the disk array must support the functions that the SSV requires.

If, for example, a fault occurs in an SSV or if an SSV needs to be re-created in another pool, delete the SSV and create it again.

### 2.1.3.3 Deleting a Solution Reserved Volume on the iSM Client Screen

---

A solution reserved volume can be deleted on the Delete Logical Disk screen of the iSM client. For details of the iSM client, refer to “Delete Logical Disk” in the “Configuration Setting Tool User’s Manual (GUI) for the M Series.”



### 2.1.3.4 Deleting a Solution Reserved Volume by Using the iSMcfg Command

To delete a created SSV, connect to the disk array and execute the command in the format below. Specify the LD number or the LD name of the created SSV as the LD number or the LD name.

#### [ Syntax ]

```
iSMcfg ldunbind {-ldn LD_Number | -ldname LD_Name } -force
```

In a VVOL environment, if a virtual machine's snapshot or clone has been created, it is usually not possible to delete the SSV. If, however, a fault occurs in the physical disk configuring an SSV, placing the SSV in a faulty state, the system volume can be deleted for re-creation.



Note the following when deleting the created SSV:

- If you delete the SSV while the system is operating, be sure to recreate the SSV. If you turn off the disk array with the SSV deleted while the system is operating, information of the created snapshots and clones may not be stored and the data of the disk array may be lost.

## 2.1.4 Creating and Deleting a Protocol Endpoint

All I/O operations between ESXi hosts and VVOLs are performed via a special logical disk called a Protocol Endpoint (PE).

Create a Protocol Endpoint in a pool created as a Storage Container.

### Execution example 1: Create a Protocol Endpoint on the iSM client screen.

Select [Protocol Endpoint] on the Create Logical Disk (System / Control Volume) screen of the iSM client.

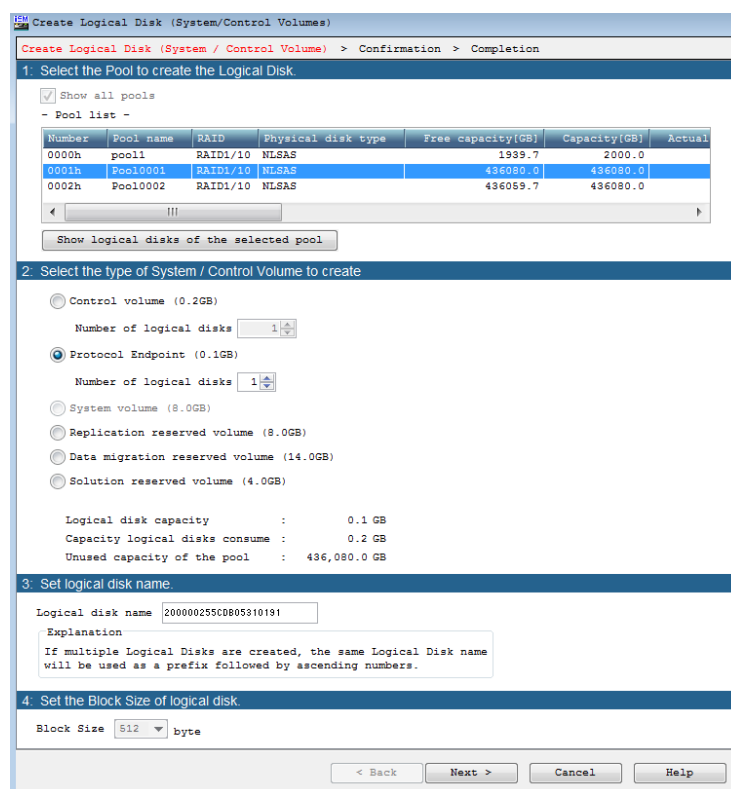

Figure 2-3 Protocol Endpoint Creation Screen of the iSM Client

For details of the iSM client, refer to “Create Logical Disk (System/Control Volume)” in the “Configuration Setting Tool User’s Manual (GUI) for the M Series.”

### Execution example 2: Create a Protocol Endpoint by using the `iSMcfg` command.

```
# iSMcfg ldbind -poolnumber 0001h -ldn 0001h -ldattr pe
```

For more information about the `iSMcfg poolbind` command, refer to the section “iSMcfg poolbind” in the “Command Reference.”

The created Protocol Endpoint must be allocated to an ESXi host. A single Protocol Endpoint can be shared by multiple ESXi hosts. For more information about the allocation procedure, refer to the “Configuration Setting Tool User’s Manual (GUI) for the M Series” or “the section “iSMcfg addldsetld” in the “Command Reference.”

After allocating the Protocol Endpoint to an ESXi host, you need to start access control for the disk array. For more information about the procedure to start access control, refer to the “Configuration Setting Tool User’s Manual (GUI) for the M Series” or the section “iSMcfg startacc” in the “Command Reference.”



Up to eight Protocol Endpoints can be created in a single disk array unit.



Note the following when creating a Protocol Endpoint:

- I/O between a VVOL and a host is performed via a Protocol Endpoint. If there is only one Protocol Endpoint, I/O of all VVOLs will be concentrated to one controller. For load balancing, it is recommended to create as many Protocol Endpoints as the number of storage controllers.
- If multiple Protocol Endpoints is to be created, create them to be distributed to controllers. The procedure is described below: Of the created Storage Containers, select as many Storage Containers the pool number of one or more of which is even and the pool number of one or more of which is odd as the number of controllers, and create a single Protocol Endpoint for each of the selected Storage Containers. For example, when two pools whose pool number is 0 and 1 are Storage Containers, create a single Protocol Endpoint for each Storage Container.
- Allocate all the created Protocol Endpoint to an ESXi host. If there are multiple ESXi hosts, it is also recommended to make all the created Protocol Endpoints shared by all the ESXi hosts. In this case, make sure that all the PE LUNs match among all the ESXi hosts. Otherwise, virtual machine migration may be affected to fail.



After creating a Protocol Endpoint, confirm that the monitoring state of the disk array is “Running” (that is, iSM Express is monitoring the disk array). If disk array monitoring is stopped, restart monitoring by iSM Express. This enables VASA Provider to collect information of the disk array if the disk array is monitored by iSM.

To make iSM Express (management software) start monitoring the disk array, select [Monitor] > [Screen Operation] > [Start/Stop Monitoring] from the menu. For details, refer to “Storage Manager Express

User's Manual" > "Daily Operations" > "Elements of iSM Main Window."

To delete a created Protocol Endpoint, connect the server to the disk array and execute the following command. For *LD\_Number* or *LD\_Name*, specify the number or name of the created Protocol Endpoint.

### [ Syntax ]

```
iSMcfg ldunbind {-ldn LD_Number | -ldname LD_Name }
```

### Execution example 3: Delete a Protocol Endpoint by using the `iSMcfg` command.

```
iSMcfg ldunbind -ldn 0001h
```

For more information about the `iSMcfg poolunbind` command, refer to the section "iSMcfg poolunbind" in the "Command Reference."



Before deleting a created Protocol Endpoint, be sure to stop all virtual machines that use VVOLs in the disk array.

## 2.1.5 Creating and Deleting a Snapshot Reserve Area

This section describes how to create and delete a snapshot reserve area (SRA) on a Virtual Volume environment.

For disk arrays of M120, M320, M320F, and later, it is necessary to create an SRA.

### 2.1.5.1 Creating an SRA

#### Work flow

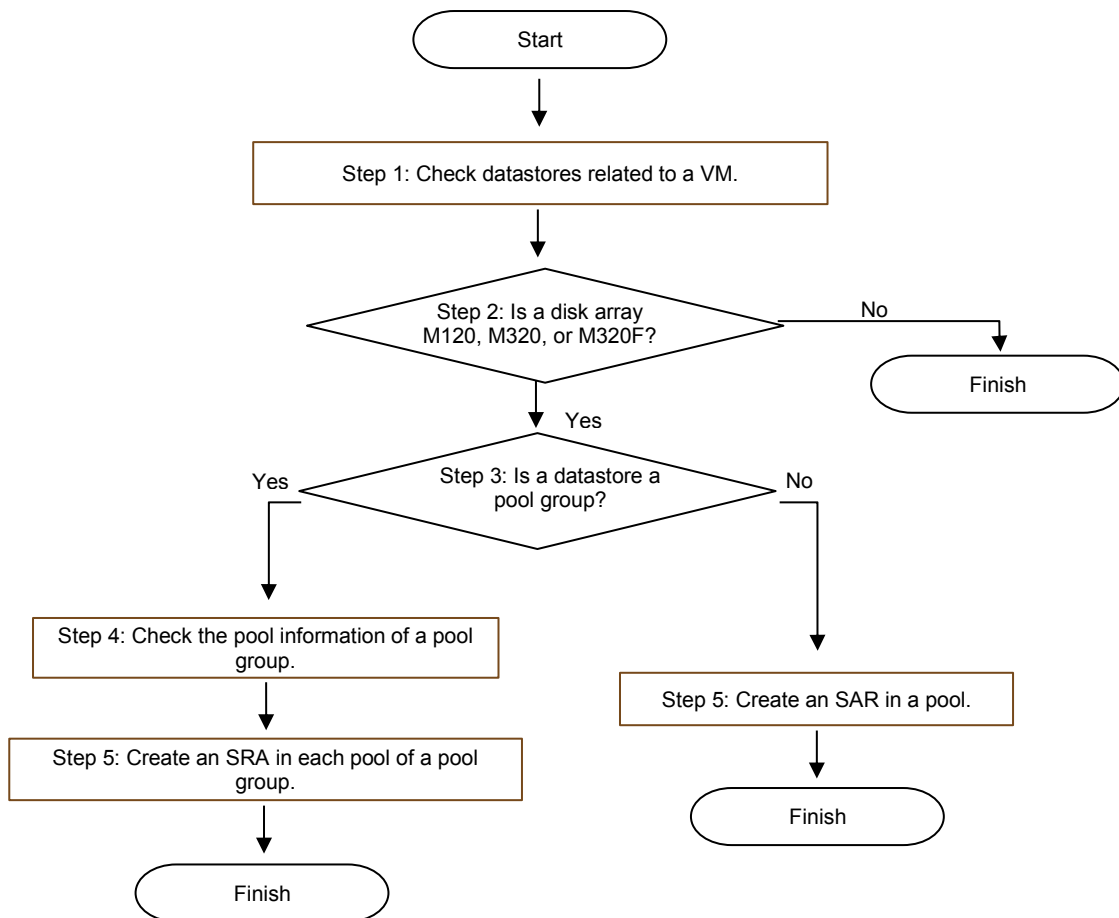

Step 1: Check datastores related to a VM.

Check datastores related to a virtual machine on the Virtual Machine Manage screen ([Related Objects] tab).

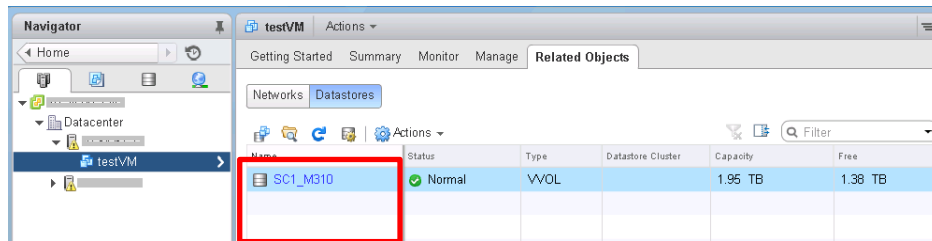

Figure 2-4 Virtual Machine Manage screen ([Related Objects] tab)

Step 2: Check the model ID of a disk array.

Check the storage array information displayed in [Storage array(s)] under [Backing Storage Container] on the Datastore Manage screen ([Manage] tab). A disk array name is displayed in [Storage array(s)].

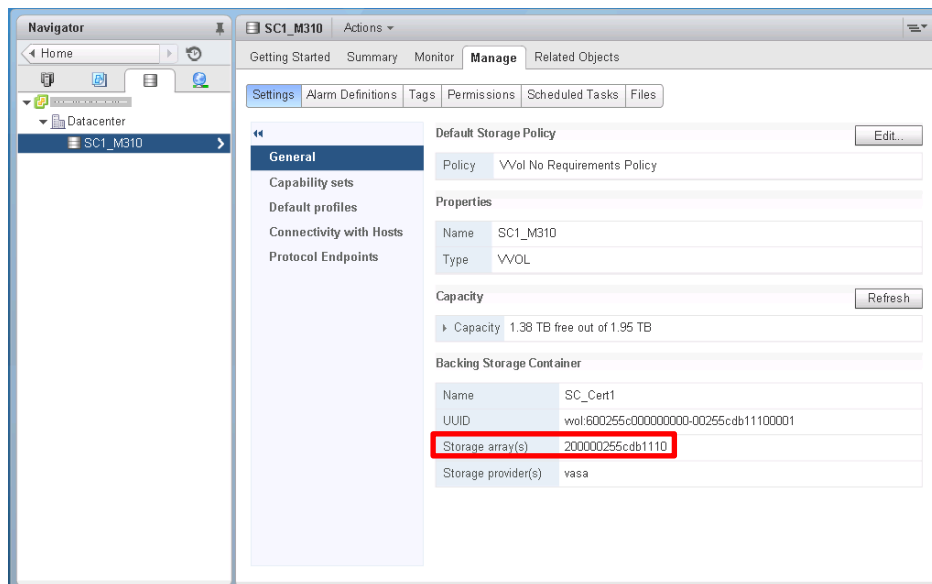

Figure 2-5 Datastore Manage screen ([Manage] Tab)

Next, open the VASA Provider Registration screen. A list of managed disk arrays is displayed under VASA Provider. Select the checked disk array name that from the list. Check the model ID of the disk array displayed for [Model ID] under [Storage System Details].

If the model ID is M120, M320, or M320F, execute the following steps.

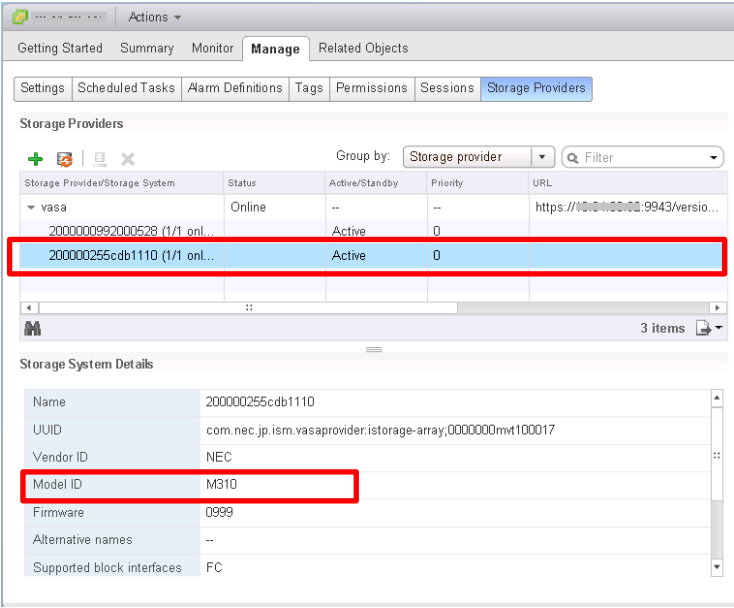

Figure 2-6 VASA Provider Registration Screen

Step 3: Check whether a datastore is a pool group.  
Check the pool group or pool number of the disk array by referring to [UUID] and [Storage array(s)] under [Backing Storage Container] on the Datastore Manage screen ([Manage] tab).  
The 16th digit of the UUID (number before a hyphen) indicates that the target is a normal pool or a pool group.  
The 16th digit is 1 for a pool group or 0 for a pool.

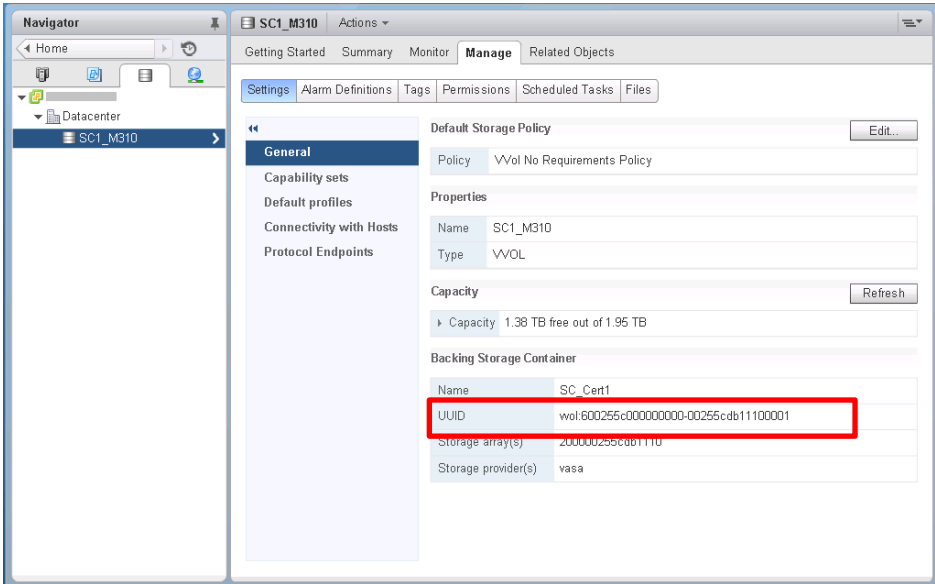

Figure 2-7 Datastore Manage screen ([Manage] Tab)

UUID: vvol: 6xxxxxx00000000w-yyyyyyyyyyyyzzz

x: 5th to 10th digits of the WWN of the storage. Hexadecimal notation.

y: Last 12 digits of the WWN of the storage. Hexadecimal notation.

z: Pool or pool group number. Hexadecimal notation.

w: A flag to distinguish a pool or pool group

1: Pool group

0: Pool

Storage array: Disk array name.

Step 4: Check information of pools in a pool group.

For details about how to check pools of a pool group, refer to the following iSM documentation:

Command Reference > Reference > Data Allocation Optimization Commands > iSMadr config\_query

[Usage Example]

Example 1: Display the settings of autonomous operation of a logical disk movement and the settings of the auto deploy function

```
# iSMadr config_query

--- Storage Information ---
Auto Move      : on
Copy Speed     : auto
Analysis Time  : Sun 12:00
Analysis Term  : 1week
Start Time     : Mon 21:00
Stop Time      : Wed 06:00

--- Pool Group Information ---
Pool Group No  : 0001h
Pool Group Name : POOLGROUP0001
High Speed Pool : 0001h
Capacity Limit of the High Speed Pool : 80%
Low Speed Pool : 0003h
Capacity Limit of the Low Speed Pool: 60%
Policy        : performance
LD Movement Mode : immediate
Purpose       : Optimize

--- Pool Group Information ---
Pool Group No  : 0002h
Pool Group Name : POOLGROUP0002
Pool Number   : 0002h, 0005h
Purpose       : Auto Deploy

--- Pool Detail Information ---
Pool No       : 0002h
Pool Capacity : 173.0GB(185,757,335,552Bytes)
Used Pool Capacity : 0.0GB(0Bytes)
Free Pool Capacity : 173.0GB(185,757,335,552Bytes)
```



```
Pool No      : 0005h
Pool Capacity : 173.0GB(185,757,335,552Bytes)
Used Pool Capacity : 0.0GB(0Bytes)
Free Pool Capacity : 173.0GB(185,757,335,552Bytes)

iSMadr: Info : iSM37000 : Command completed successfully
ExitStatus:0
```

Step 5: Create an SRA in a pool.

Create an SRA in the pool. For a pool group, create an SRA in each pool of the pool group.

For details about how to create an SRA, refer to the following iSM documentation:

Snapshot User's Manual (Function Guide) > Operating Snapshot with iSM > Creating a Volume (for the M Series) > Creating the Snapshot Reserve Area

## 2.1.5.2 Deleting an SRA

---

For details about how to delete an SRA, refer to the following iSM documentation:

Snapshot User's Manual (Function Guide) > Operating Snapshot with iSM > Deleting the Snapshot Reserved Area

## 2.2 Setting up VASA Provider

---

Following describes how to set up VASA Provider.



Whether in the case of new install or not, make sure that do 2.2.2 “Registering VASA Provider in vCenter Server” after doing 2.2.1 “Installing VASA Provider.”

### 2.2.1 Installing VASA Provider

---

#### 1. Before installation

Before installing VASA Provider, check the following:

- Checking VASA Provider

If VASA Provider is already installed, uninstall it and then install a desired version of VASA Provider.

- Checking the disk array

For VASA Provider V2.5, the revision of the storage control software enables support of disk array (M series) of 0950 or later. If the revision of the disk array to manage is older than 0950, update it to 0950. You can use `iSMview` to check the revision of the storage control software. For more information, refer to the section “Configuration Display Command (iSMview)” in the “Command Reference.”

- Checking the JRE

To use VASA Provider, the 32-bit version Java Runtime Environment (JRE) is required. Be sure to use the 32-bit version JRE when VASA Provider is used on a 64-bit OS. Since the 32-bit version JRE is not included in VASA Provider, be sure to install this JRE in advance. In addition, the path to the `bin` folder in the JRE installation folder must be set. Follow the steps below:

1. Start the command prompt.
2. Run `java` and `keytool` in a folder other than the `bin` folder in the JRE installation folder.

If the following message is displayed, the path to the `bin` folder in the JRE installation folder is not set.

```
C:\>keytool
'keytool' is not recognized as an internal or external command,
operable program or batch file
```

If the path is not set, set a path according to the following procedure:

1. From the Windows Start menu, select [Control] > [System] > [Change Settings]. The [System Properties] dialog box is displayed.

2. Click the [Environment Variables] button on the [Advance] tab. The [Environment Variable Settings] dialog box is displayed.
3. Select [Path] or [PATH] from the [System Variable List] and click the [Edit] button. The [Edit System Variable] dialog box is displayed.
4. Ensure that the variable name is Path or PATH.
5. Add a semicolon (;) at the end of the existing variable value and enter <JRE installation folder>\bin.  
For example, if the JRE installation folder is C:\Program Files (x86)\Java\jre8, add ;C:\Program Files (x86)\Java\jre8\bin at the end of the existing variable value. At this time, be careful not to change the existing variable value.
6. Click the [OK] button to commit the change.
7. Start the command prompt.
8. Run java and keytool.

```
C:\>java
Usage: java [-options] class [args...]
       :

C:\>keytool
Key and Certificate Management Tool
       :
```

If the above message is displayed, the path is set successfully.

## 2. Installation

1. Log on to Windows with administrative rights and execute SETUP.exe.  
If the [User Account Control] dialog box is shown, click [Continue] or [Yes] to start the setup.  
Read all of the license agreement and select [I accept the terms of the license agreement].
2. On the Choose Destination Location screen, select the folder in which to install VASA Provider.  
If you want to change the displayed destination folder, click [Browse] and select the desired folder.

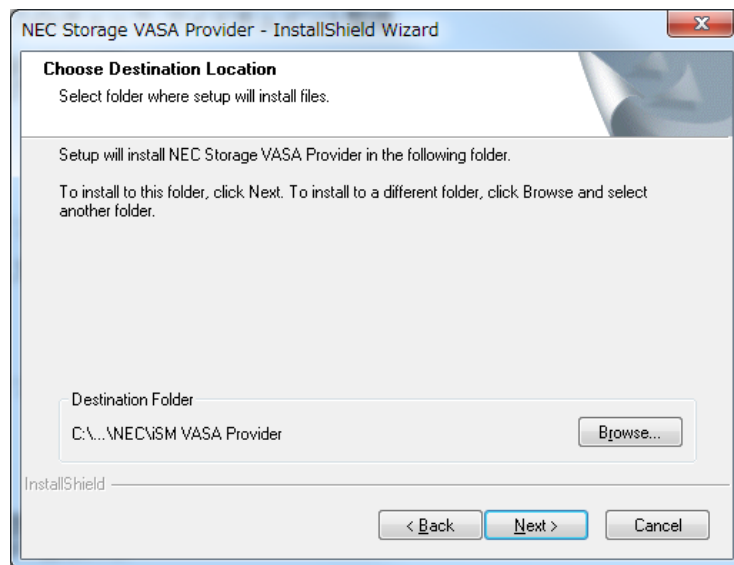

Figure 2-8 Choose Destination Location Screen

3. On the Port Number Settings of NEC Storage VASA Provider screen, specify four ports for VASA Provider.  
If the displayed port numbers are already used by another application, change the port numbers. Port Number 4 is used to register VASA Provider with vCenter Server. The port numbers that are set on this screen cannot be changed after installing VASA Provider.

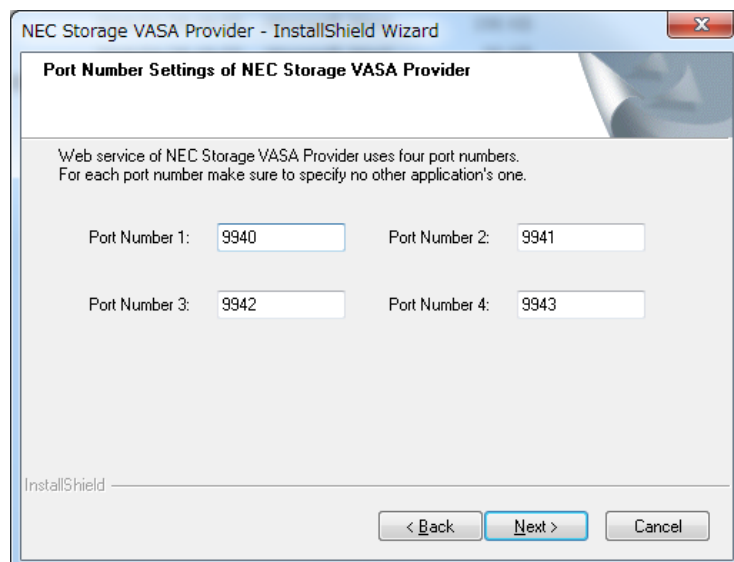

Figure 2-9 Port Number Settings of NEC Storage VASA Provider Screen

4. On the Settings of Account for NEC Storage VASA Provider screen, specify the user name and password for VASA Provider.

Enter the desired user name and password, and then enter the password again for confirmation.

The user name and password that are specified on this screen are used to register VASA Provider

Figure 2-10 Settings of Account for NEC Storage VASA Provider Screen



Specify the user name and password of the VASA Provider according to the following rules:

- The maximum number of characters is 255.
- The user name and password are case-sensitive.
- Alphanumeric characters and the following symbols can be used:

!"#\$%&'()\*+,-./:;<=>?@[\\]^\_`{|}~

5. On the Registering Disk Array screen, register the disk arrays that VASA Provider will manage. Enter the floating IP address of each disk array and click [Add] to register it. To delete a registered disk array, select the IP address of the disk array to be deleted and click [Delete]. Up to four disk arrays can be registered. Only IPv4 can be used for an IP address.

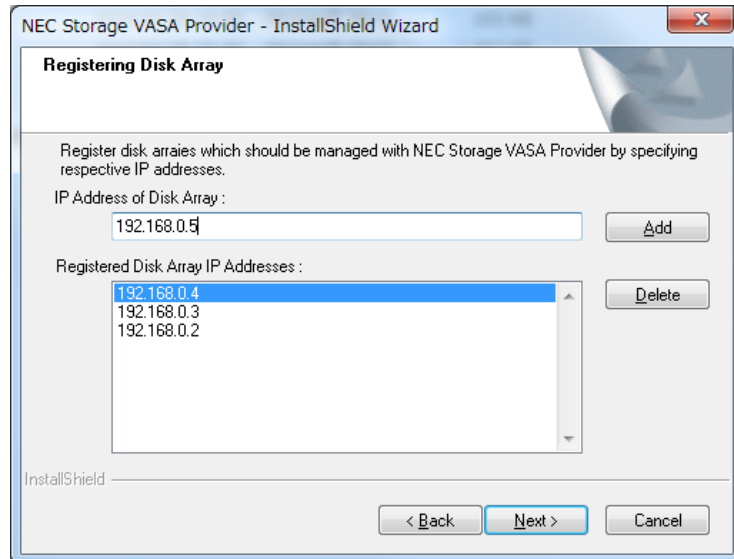

Figure 2-11 Registering Disk Array Screen

6. On the Registering VMware vCenter Server Information screen, register the information of the vCenter Server that manages VASA Provider. Enter the IP address and HTTPS port number that vCenter Server uses and the user name and password for vCenter Single Sign On. Only IPv4 can be used for an IP address.

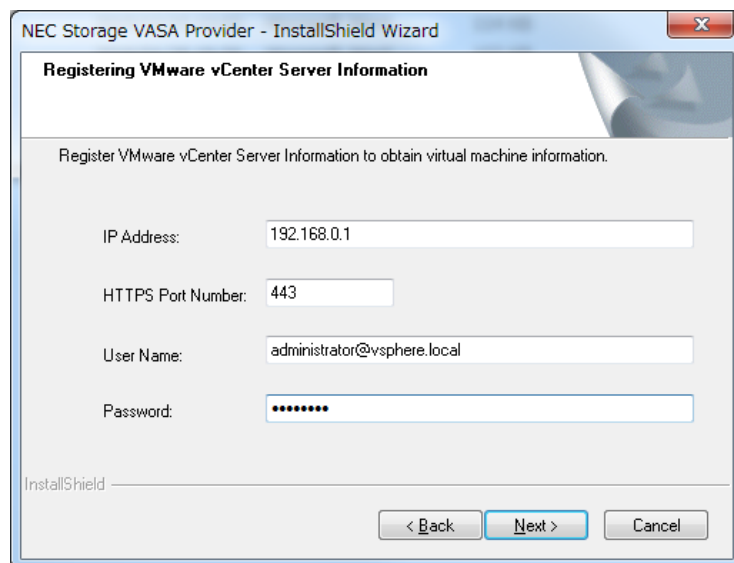

Figure 2-12 Registering VMware vCenter Server Information Screen

7. On the Specifying Interval of Outputting Configuration Information File screen, specify the interval to output the configuration file in which virtual machine information is associated with storage information.

The specifiable value range of the output interval is 5 to 1440. The unit is minutes.

The default value is five minutes.

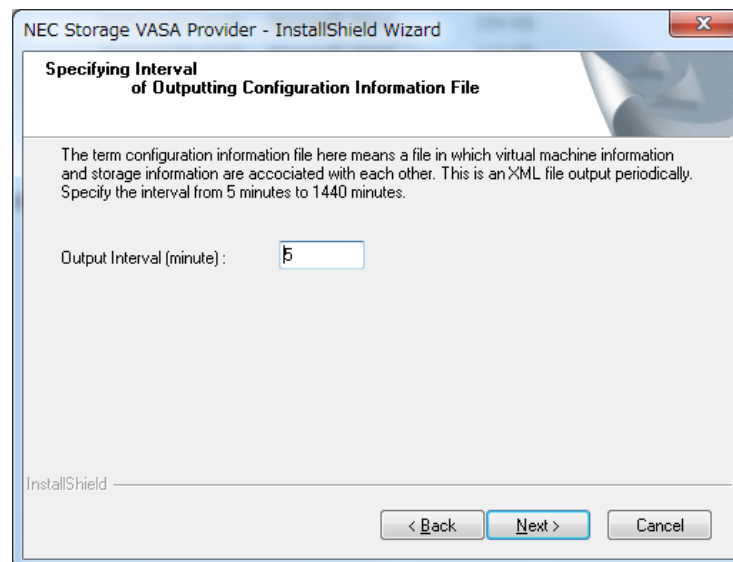

Figure 2-13 Specifying Interval of Outputting Configuration Information File Screen

### 3. Settings after installation

Following describes the settings required after installing VASA Provider.

- Configuring Windows firewall

To enable communication between VASA Provider and vCenter Server, Port Number 1 (9940 by default) and Port Number 4 (9943 by default) that was specified when installing VASA Provider needs to be set to the Windows firewall.

The VASA Provider installer sets “domain”, “private”, or “public” to the Windows firewall profile. If you want to change the profile to accord with your environment, change the settings after installing VASA Provider.

## 2.2.2 Registering VASA Provider in vCenter Server

After installing a VASA Provider, it is required to register the VASA Provider to vCenter Server.

Following describes how to register VASA Provider with vCenter Server.

For details, refer to the vSphere 6.0 documentation provided by VMware.

A certificate is not needed for this VASA Provider.

Start VMware vSphere Web Client and connect to vCenter Server.

Open the window for VASA Provider registration by using the following procedure:

1. Click [Hosts and Cluster] under [Home].
2. Select [vCenter Server] under the [Navigator].
3. Click [Storage Providers] on the [Manage] tab.
4. On the Storage Providers window, click [Add] to open the window for registration.
5. Enter the following information and click [OK].

Item	Input Contents
Name	Enter a name you want to use.
URL	Specify the URL in the following format: <code>https://&lt;IP address of the VASA Provider installation server&gt;:&lt;Port number 4 set at installation&gt;/version.xml</code>  Only IPv4 can be used for an IP address. Example: <ul style="list-style-type: none"> <li>• Server IP address: 192.168.1.100</li> <li>• Port number 4: 9943</li> </ul> <code>https://192.168.1.100:9943/version.xml</code>
Log in	Enter the user name you used for installation.
Password	Enter the password you used for installation.

If VASA Provider is reinstalled, you need to register it to vCenter Server again. After reinstalling VASA Provider, delete the previous registration from vCenter Server, and then register the newly installed VASA Provider to vCenter Server again.

For details about how to register to vCenter Server, refer to the following VMware documentation:

ESXi and vCenter Server 6.0 Documentation > vSphere Storage > Using Storage Providers > Register Storage Providers

For details about how to unregister from vCenter Server, refer to the following VMware documentation:

ESXi and vCenter Server 6.0 Documentation > vSphere Storage > Using Storage Providers > Unregister Storage Providers



## 2.3 Maintenance of VASA Provider

Following describes the maintenance (settings modification and uninstallation) of VASA Provider.

### 2.3.1 Modification of Settings

Following describes how to modify VASA Provider settings. You can:

- register or change a user name and password of VASA Provider,
- register or unregister a disk array,
- change the output interval of the configuration file (XML file) in which virtual machine information is associated with storage information, and
- register or change the IP address, user name, and password for vCenter Server.



It is required to restart VASA Provider if you:

- registered or changed the user name and password of VASA Provider,
- registered or unregistered a disk array, or
- changed the output interval of the configuration file (XML file) in which virtual machine information is associated with storage information.

#### 1. Settings Modification

- Changing the user name and password of VASA Provider

The following covers the steps to change a user name and password you have set during the installation.

1. Start the command prompt as an administrator (by selecting [Run as Administrator] from the short-cut menu).
2. Navigate to <VASA Provider installation folder>\bin.
3. Run the SetProviderConf command with the -s option.

```
C:\Program Files (x86)\NEC\ISM VASA Provider\bin>SetProviderConf -s
<user name><password>
Set successfully!
```

When the user name and password are successfully changed, the message “Set successfully!” is shown.



Specify the user name and password of the VASA Provider according to the following rules:

- The maximum number of characters is 255.
- The user name and password are case-sensitive.
- Alphanumeric characters and the following symbols can be used: Spaces cannot be used.

!"#\$%&'()\*+,-./:;<=>?@[\\]^\_`{|}~



If the user name or password includes a symbol, surround the user name or password with double quotation marks (").

If the user name or password includes a double quotation ("), input it as "" or \" in the command line. If a backslash is followed by a double quotation ("), input it as \\".

If the user name or password ends with a backslash (\), input it as \\.

- Registering/Unregistering a disk array

The following covers the steps to register and unregister a disk array.

1. Start the command prompt as an administrator (by selecting [Run as Administrator] from the short-cut menu).
2. Navigate to <VASA Provider installation folder>\bin.
3. Run the SetProviderConf command.

- To register a disk array, run the SetProviderConf command, with the -a option. Specify a floating IP address of the disk array as the argument. Only IPv4 can be used for an IP address.

```
C:\Program Files (x86)\NEC\iSM VASA Provider\bin>SetProviderConf -a
<IP-address>
ADD successfully!
```

When the disk array is successfully registered, the message “ADD successfully!” is shown.

- To see a list of registered IP addresses, run the SetProviderConf command with the -l option. Use this option after the registration to confirm the registration has completed successfully.

```
C:\Program Files (x86)\NEC\iSM VASA Provider\bin>SetProviderConf-l
[DISKARRAY]
<IPaddress>
```

- If a wrong IP address is registered by mistake, run the SetProviderConf command with the -d option, which deletes a registered IP address. Specify the IP address you want to delete for the argument.

```
C:\Program Files (x86)\NEC\iSM VASA Provider\bin>SetProviderConf -d
<IPaddress>
Delete successfully!
```

When deletion is successfully completed, the message “Delete successfully!” is shown.

- Specifying the interval of outputting the configuration file (XML file) in which virtual machine information is associated with storage information

When the configuration is changed, the configuration file is output. The default interval of

outputting the configuration file is five minutes.

Execute the following procedure to change the interval from the default value.

1. Start the command prompt as an administrator (by selecting [Run as Administrator] from the short-cut menu).
2. Navigate to <VASA Provider installation folder>\bin.
3. Run the `SetProviderConf` command with the `-t` option to specify the interval of outputting the configuration file.

```
C:\Program Files (x86)\NEC\iSM VASA Provider\bin>SetProviderConf -t
<interval of outputting the configuration file>
Set successfully!
```

When the configuration is successfully changed, the message “Set successfully!” is shown.

You can specify an interval from 5 to 1440 minutes. If the specified interval is out of the allowable range, the following message is shown. Specify the correct value and execute the command again.

```
ERROR:Invalid time value. Please set up an integer between 5 and 1440.
```

- Changing the vCenter Server IP address, user name, and password

The following covers the steps to change the IP address, user name and password of vCenter Server.

1. Start the command prompt as an administrator (by selecting [Run as Administrator] from the short-cut menu).
2. Navigate to <VASA Provider installation folder>\bin.
3. Run the `SetProviderConf` command, with the `-v` option specified, to change the IP address and port number(\*) of vCenter Server and the Single Sign On user name and password. Only IPv4 can be used for an IP address.

\* The default HTTPS port number is 443.

```
C:\Program Files (x86)\NEC\iSM VASA Provider\bin>SetProviderConf -v
<IP address> <HTTPS port> <user name> <password>
Set successfully!
```

When the IP address, user name and password are successfully changed, the message “Set successfully!” is shown.



The following symbols cannot be used in a user name and password.

" & ', ; < = > ^ |



If the user name or password includes a symbol, surround the user name or password with double quotation marks (“”).

If the user name or password ends with a backslash (\), input it as \\.

### 2. Restarting VASA Provider

Be sure to restart VASA Provider if any of the following operations were executed:

- Changing the user name and password for VASA Provider
- Registering or deleting a disk array to or from VASA Provider.
- Changing the interval of outputting the configuration file (XML file) in which virtual machine information is associated with storage information.

Execute the procedure below:

1. On the Windows [Start] menu, select [Control Panel], [Administrative Tools], and [Services]. The Services window is open.
2. Select and right-click [NEC Storage VASA Provider 32-bit iSM\_VASA\_Provider] from the list of services.
3. Select [Restart] from the shortcut menu. VASA Provider will restart.

### 3. Registering VASA Provider in vCenter Server

If the following operation is executed, be sure to subsequently register VASA Provider to vCenter Server:

- Change of a user name / password of VASA Provider

For the procedure to register, refer to 2.2.2 “Registering VASA Provider in vCenter Server.”

## 2.3.2 Uninstallation

Following describes how to uninstall VASA Provider.

- **Deleting the created Storage Container and deallocating the PE from the ESXi host (This step is not necessary when reinstalling VASA Provider)**

Before uninstalling VASA Provider, perform the following:

1. Unmount the Storage Container.
2. Deallocate the PE from the ESXi host.
3. Delete the PE.
4. Delete the pool corresponding to the unmounted Storage Container.

For details about how to unmount a Storage Container (step 1) and how to delete a pool (step 4), refer to 3.2.2 “Deleting a Datastore.”

For details about how to deallocate a PE from an ESXi host (step 2), refer to 3.4.2 “Deleting a Server.”

For details about how to delete a PE (step 3), refer to 2.1.4 “Creating and Deleting a Protocol Endpoint.”

- **Uninstalling the program**
  1. On the Windows [Start] menu, select [Control Panel] and [Programs and Features] to open the [Uninstall or change a program] window.
  2. In the installed programs, right-click NEC Storage VASA Provider and select [Uninstall].

- **Unregistering VASA Provider from vCenter Server**

Refer to the following document to unregister the VASA Provider from vCenter Server:

ESXi and vCenter Server 6.0 Documentation > vSphere Storage > Using Storage Providers > Unregister Storage Providers

Uninstallation of VASA Provide is now completes.

# Chapter 3 Basic Operations

This chapter explains the basic operations for VVOLs, such as VVOL configuration management on the iSM side and the vCenter side, adding and deleting Storage Containers, adding and deleting virtual machines in a Virtual Volume environment, migration, snapshots, and clones.

## 3.1 Configuration Management

Following describes how to manage the VVOL configuration on iSM and vCenter.

### 3.1.1 Displaying VVOL-Related Resources on the iSM Client Screen

Following describes how to display VVOL-related resources on the iSM client screen.

#### 1. Storage Container

A Storage Container is displayed as a pool.

“Container” is displayed for [VMware Type] on the iSM client pool properties screen.

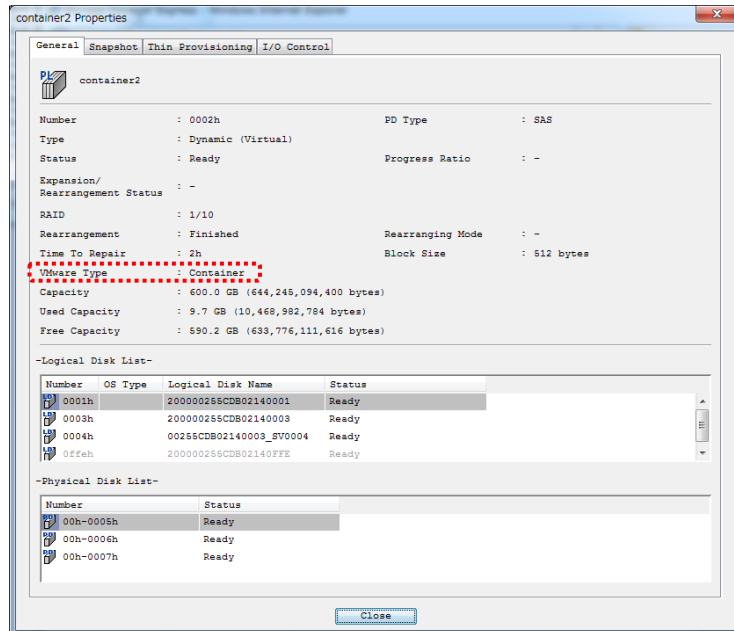

Figure 3-1 Pool Properties Screen

## 2. VVOL

A VVOL is displayed as a logical disk.

“VVOL” is displayed in the [Purpose] column on the iSM client logical disk list screen.

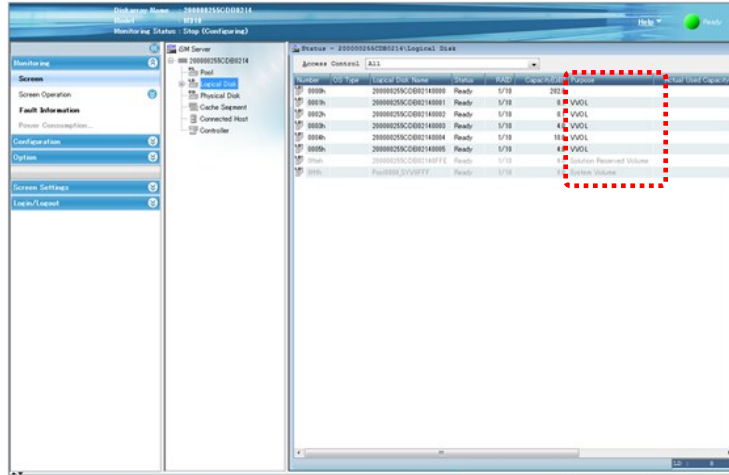

Figure 3-2 Logical Disk List Screen - VVOL

The type of a VVOL can be checked from the display item [VMware Type] on the logical disk properties screen.

VVOL types are as follows.

- config-VVOL: Configuration file of the virtual machine
- vmdk-VVOL: Hard disk of the virtual machine
- swap-VVOL: Memory swap space of the virtual machine
- memory-VVOL: Memory information when creating a snapshot of the virtual machine

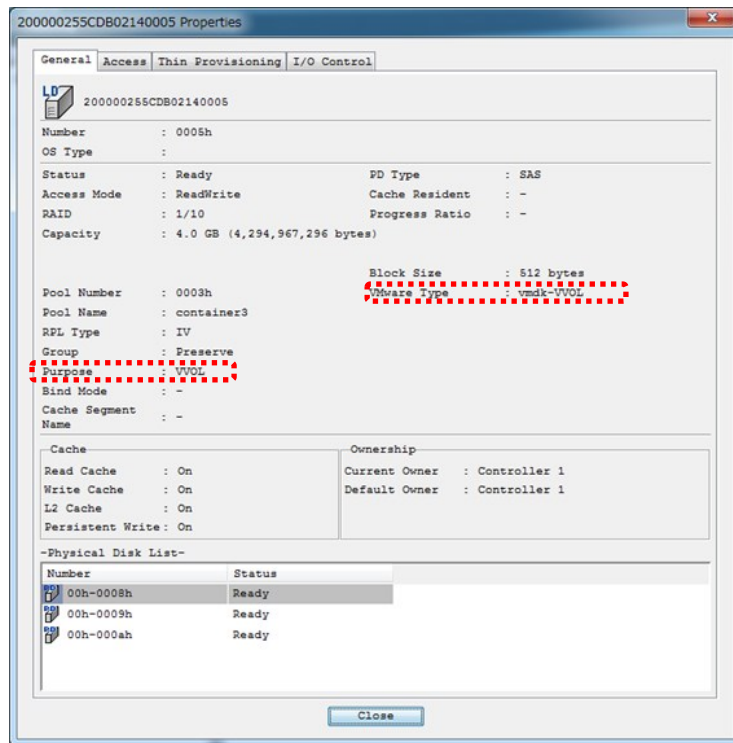

Figure 3-3 Logical Disk Properties - VVOL



### 3. Protocol Endpoint

A Protocol Endpoint is displayed as a logical disk.

“PE” is displayed for [VMware Type] on the iSM client logical disk properties screen.

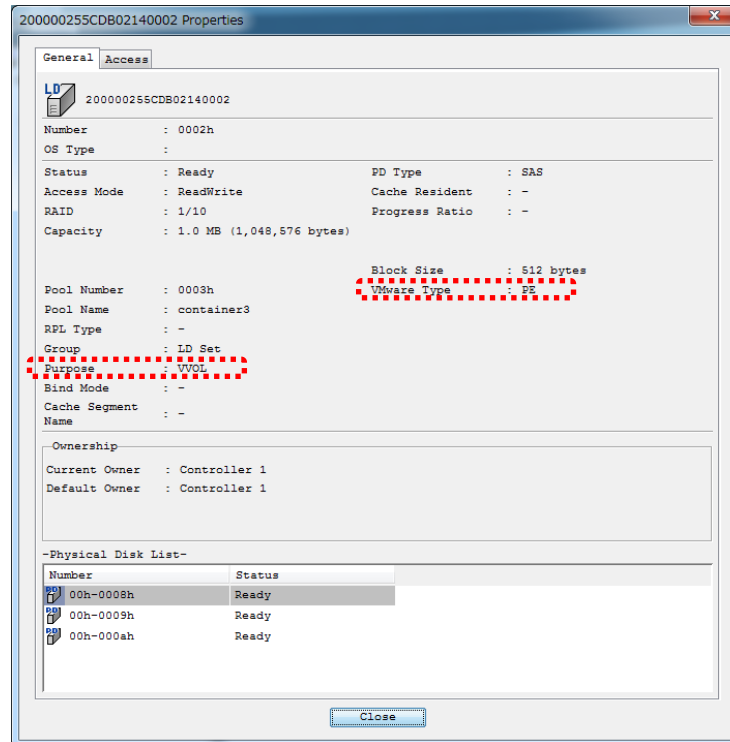

Figure 3-4 Logical Disk Properties - PE

#### 4. Volumes to be used by the volume clone function (FEV/FCV)

An FEV (logical disk to be used as a maser) and FCV (clone logical disk created from an FEV) are displayed as logical disks.

For an FEV, “Snapshot/Clone” is displayed for [Purpose] on the [General] tab of the iSM client logical disk properties screen.

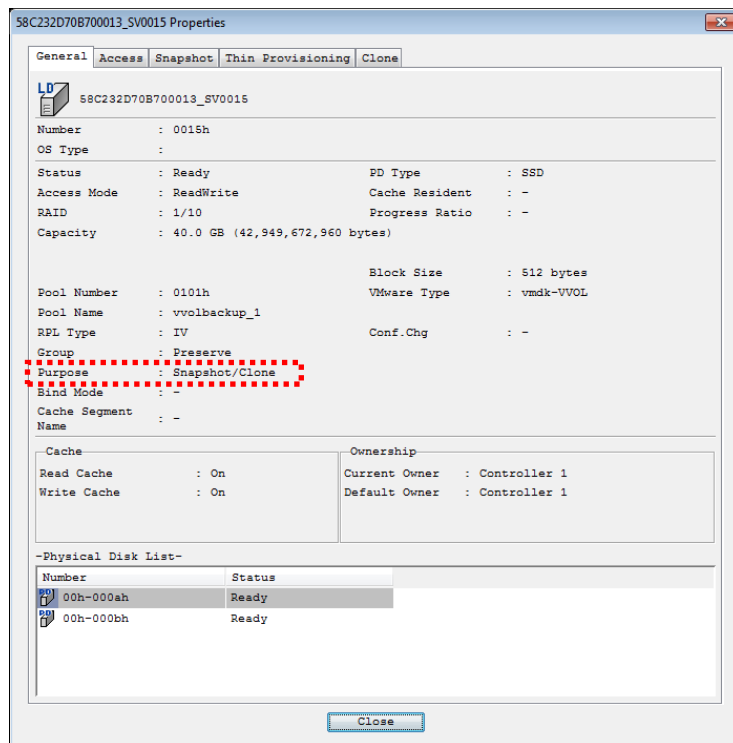

Figure 3-5 Logical Disk Properties - FEV

“FEV” is displayed for [Clone Type] on the [Clone] tab of the iSM client logical disk properties screen.

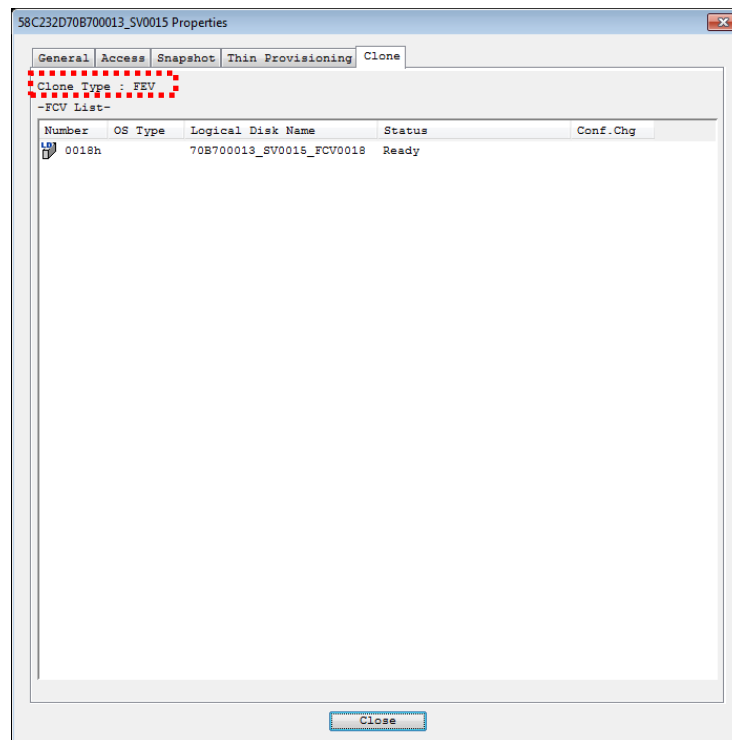

Figure 3-6 [Clone] tab of Logical Disk Properties - FEV

For FCV, “Clone” is displayed for [Purpose] on the [General] tab of the iSM client logical disk properties screen.

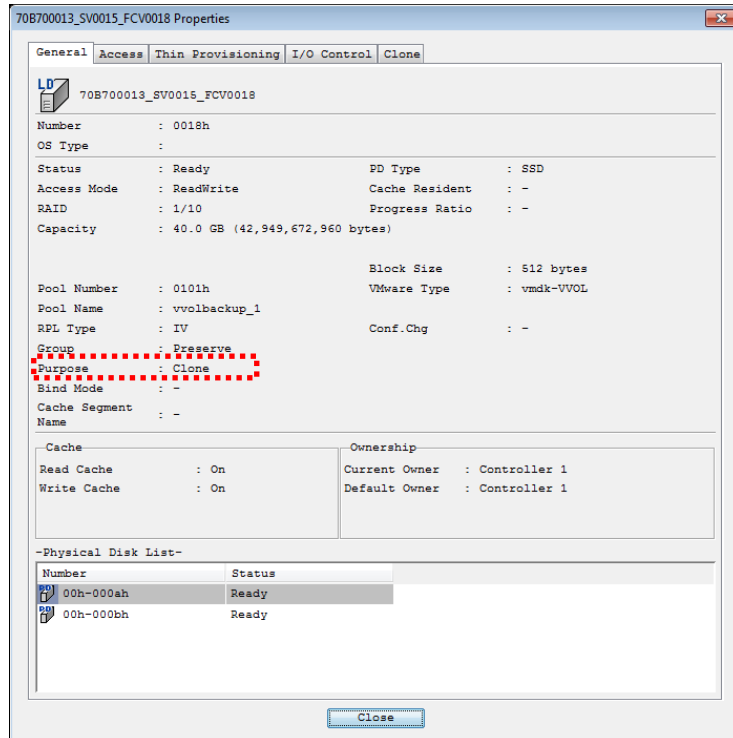

Figure 3-7 Logical Disk Properties - FCV

“FCV” is displayed for [Clone Type] on the [Clone] tab of the iSM client logical disk properties screen.

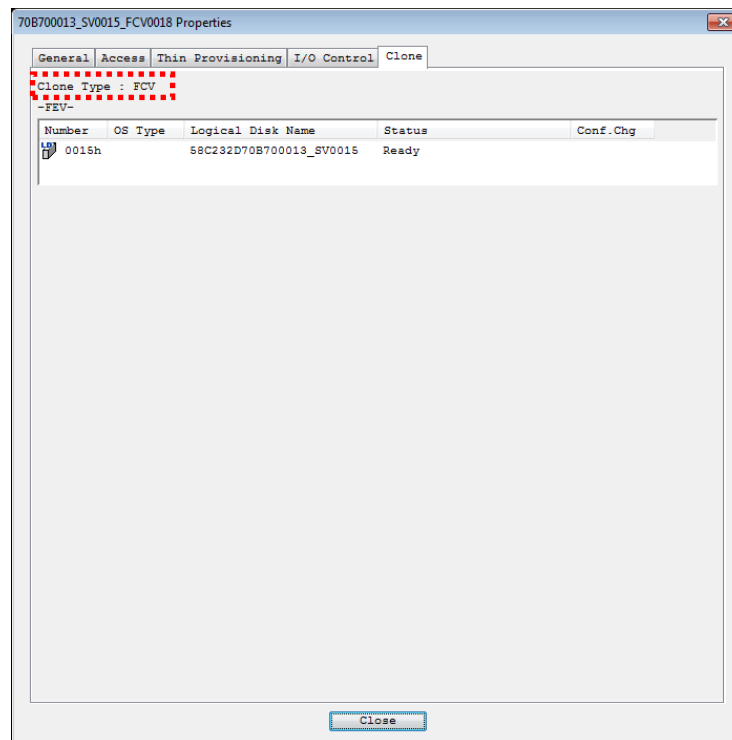

Figure 3-8 [Clone] tab of Logical Disk Properties - FCV

### 5. Solution Reserved Volume

A solution reserved volume is displayed as a logical disk.

On the [General] tab of the iSM client logical disk properties screen, a logical disk used as a solution reserved volume is displayed highlighted in gray in the physical disk list and “Solution Reserved Volume” is displayed for [Purpose].

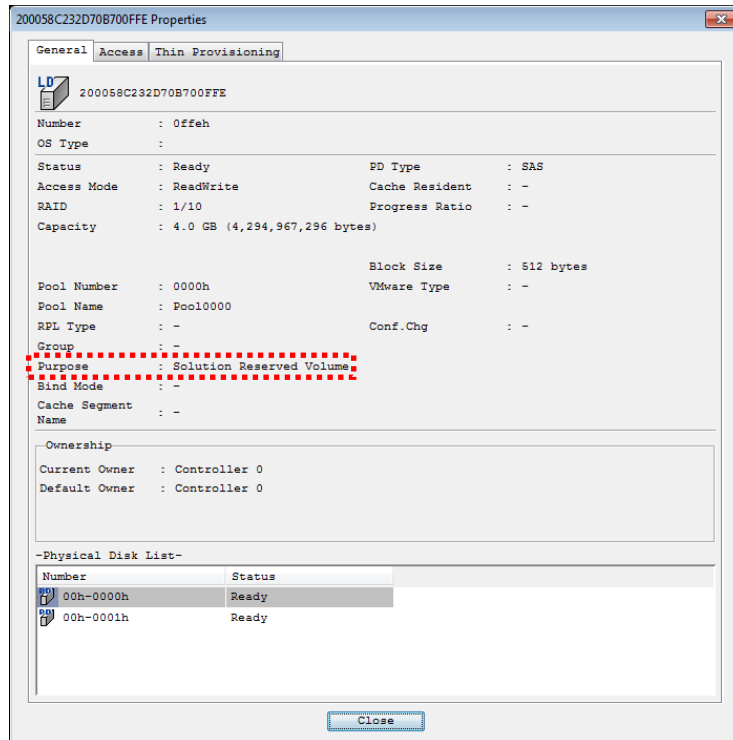

Figure 3-9 Logical Disk Properties - Solution Reserved Volume

## 6. Volumes related to the snapshot to be used in the VVOL environment (EBV/ESV/BV/SV)

A volume related to the snapshot to be used in the VVOL environment is displayed as a logical disk.

“Snapshot” is displayed for [Purpose] and “vmdk-VVOL” is displayed for [VMware Type] on the [General] tab of the iSM client logical disk properties screen.

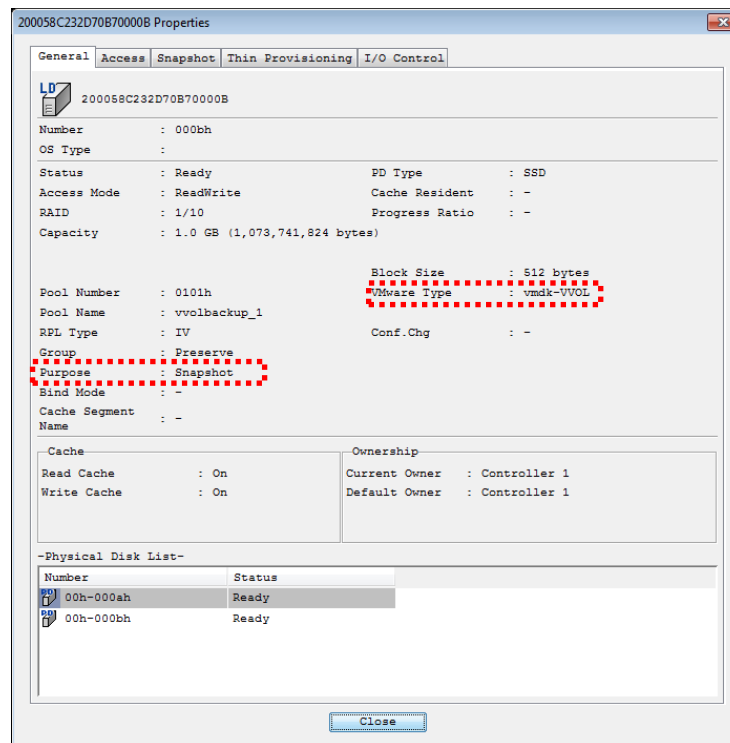

Figure 3-10 Logical Disk Properties - A volume related to the snapshot function in the VVOL environment

For a base-volume (EBV) to be used in the VVOL environment, “EBV” or “BV” is displayed for [Snapshot Type] on the [Snapshot] tab of the iSM client logical disk properties screen.

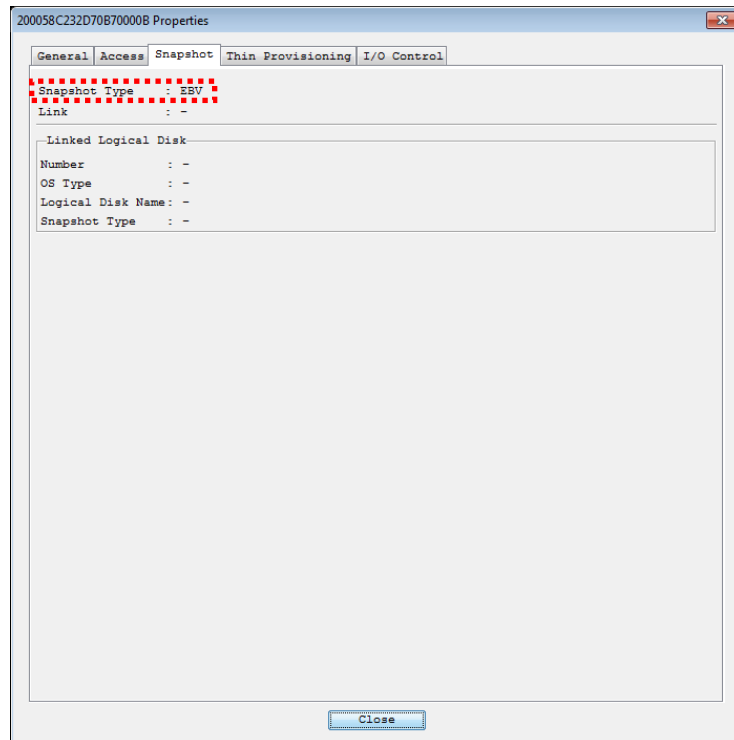

Figure 3-11 Logical Disk Properties - Base-Volume To Be Used in the VVOL environment



For a snapshot-volume (ESV) to be used in the VVOL environment, “ESV” or “SV” is displayed for [Snapshot Type] on the [Snapshot] tab of the iSM client logical disk properties screen.

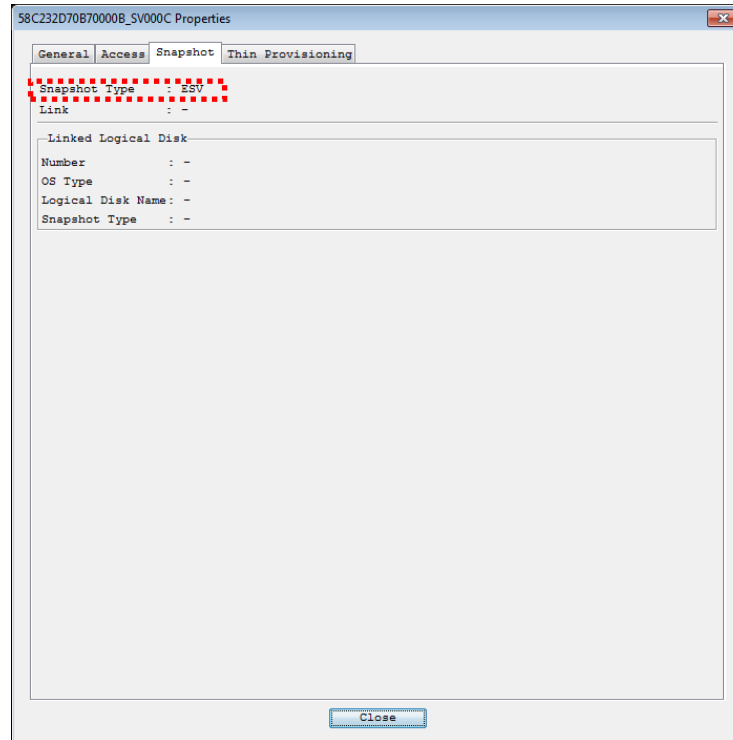

Figure 3-12 Logical Disk Properties - Snapshot-Volume To Be Used in the VVOL environment

## 3.1.2 Displaying VVOL-Related Resources by Using the Configuration Display Command

Following describes how to display VVOL-related resources by using the configuration display command (iSMview). For more information about the configuration display command, refer to the section “Configuration Display Command (iSMview)” in the “Command Reference.”

In this section, PE refers to a Protocol Endpoint, and Container refers to a Storage Container.

### 1. Storage Container

A Storage Container is displayed as a pool.

#### a) Displaying a list of pools

If you wish to perform a check on a list display, specify the `-pl` option.

The following is a display example obtained if `Storage001` is specified for the disk array name.

```
> iSMview -pl Storage001

--- Pool Information ---
Pool No. (h) Pool Name Pool Type PD Type Pool State Threshold VMware
Type
0000 Pool0000 dynamic NLSAS ready ---
0001 Pool0001 dynamic(virtual) NLSAS ready --- Container
0002 Pool0002 dynamic(virtual) NLSAS ready --- Container
```

Following describes detailed items about a Storage Container.

VMware Type: VMware type of the pool.

For a Storage Container, `Container` is displayed.

For other than a Storage Container, `---` is displayed.

#### b) Displaying detailed information about a pool

If you wish to perform a check on a detailed information display, specify either the `-pln` or `-plm` option.

The following is a display example obtained if `Storage001` is specified for the disk array name and `0000h` is specified for Pool Number.

```
> iSMview -pln Storage001 0000h

--- Pool Detail Information ---
Pool No. (h) : 0000
Pool Name : pool1
Pool Type : dynamic(virtual)
RAID Type : RAID1/10
PD Type : NLSAS
Pool State : ready
Expansion/
```

```

Rearrangement State      : ---
Rearrangement           : Finished
Rebuild Time(hour)      : 42
Expansion Time(hour)    : 0
Rearranging Mode        : ---
Pool Capacity           : 1817.0GB(1,950,988,894,208Bytes)
Used Pool Capacity      : 245.2GB(263,335,182,336Bytes)
Free Pool Capacity      : 1571.7GB(1,687,653,711,872Bytes)
PD List(h)              : 00-0000,0808
Expanding PD List(h)    : ---
Block Size              : 4,096byte
VMware Type             : Container
...

```

Following describes detailed items about a Storage Container.

VMware Type: VMware type of the pool.  
 For a Storage Container, Container is displayed.  
 For other than a Storage Container, --- is displayed.

## 2. VVOL, PE, solution reserved volume, FEV/FCV, and EBV/ESV

The following volumes are displayed as logical disks:

- VVOL
- PE
- Solution reserved volume
- Volumes used by the volume clone function (FEV/FCV)
- Volumes used by the extended snapshot function (EBV/ESV)

### a) Displaying a list of logical disks

If you wish to perform a check on a list display, specify the `-l` option.

The following is a display example obtained if `Storage001` is specified for the disk array name.

```

> iSMview -l Storage001
--- LD Information ---
LDN(h) OS Type LD Name          PD Type  Conf.Chg LD State  Threshold VMware Type
0000  NX      pool1_0000          NLSAS   Conf.Chg ready    ---      PE
0001  NX      20000009910077770001 NLSAS   Conf.Chg ready    ---      swap-VVOL
0002  NX      20000009910077770002 NLSAS   Conf.Chg ready    ---      vmdk-VVOL
0003  NX      20000009910077770003 NLSAS   Conf.Chg ready    ---      vmdk-VVOL
0004  NX      20000009910077770004 NLSAS   Conf.Chg ready    ---      config-VVOL

```

Following describes detailed items about a VVOL and PE.

VMware Type: VMware type of the logical disk.  
 For a VVOL, config-VVOL, vmdk-VVOL, swap-VVOL, or memory-VVOL is displayed.  
 For a PE, PE is displayed.  
 For a logical disk other than a VVOL and PE, --- is displayed.

b) Displaying detailed information about a logical disk

If you wish to perform a check on a detailed information display, specify the `-ln` option.

The following is a display example obtained if `Storage002` is specified for the disk array name and `0000h` is specified for LDN.

```

> iSMview -ln Storage002 0000h

--- LD Detail Information ---
LDN(h)                : 0000
OS Type               : WN
LD Name               : TEST_VOLUME
LD Capacity           : 5.0GB(5,368,709,120Bytes)
Pool No.(h)           : 0000
Pool Name             : Pool0000
RaidType              : RAID1/10
PD Type               : SAS
LD State              : ready
Capacity Allocation   : virtual
Access Mode           : ReadWrite
Expansion/
Rearrangement State   : ---
Group                 : Preserve
Purpose               : VVOL
RPL Attribute         : IV
Snapshot Attribute    : ---
Current Owner         : 00
Default Owner         : 00
Cache Resident        : no
PD List(h)            : 00-0000,0001,0002
Segment Number(h)     : 00
Segment Name          : DefaultSegment
Read Cache Mode       : on
Write Cache Mode      : on
L2 Cache Mode         : on
L2 Persistent Write   : on
Configuration Change  :
Data Migration State  : ---
Movement State        : ---
Block Size            : 512byte
Clone Attribute       : ---
VMware Type           : vmdk-VVOL
Bound PE List(h)      : 0400,0401
...

```

Following describes the display items for VVOL, PE, solution reserved volume, FEV, FCV, ESV, and EBV.

Purpose:	LD attribute.
	For a VVOL or PE, VVOL is displayed.
	For a solution reserved volume, Solution Reserved Volume is

- displayed.  
 For an FEV, `Snapshot/Clone` is displayed.  
 For an FCV, `Clone` is displayed.  
 For an EBV and ESV, `Snapshot` is displayed.
- VMware Type: VMware type of the logical disk.  
 For a VVOL, `config-VVOL`, `vmdk-VVOL`, `swap-VVOL`, or `memory-VVOL` is displayed.  
 For a PE, `PE` is displayed.  
 For a logical disk other than a VVOL and PE, `---` is displayed.
- Snapshot Attribute: Snapshot type  
 For an EBV, `EBV` is displayed.  
 For an ESV, `ESV` is displayed.  
 For a logical disk that is not related to a snapshot, `---` is displayed.
- Clone Attribute: Volume clone type  
 For an FEV, `FEV` is displayed.  
 For an FCV, `FCV` is displayed.  
 For a logical disk that is not related to a volume clone, `---` is displayed.
- Bound PE List(h): Logical disk numbers of bound PEs. They are displayed only if the specified logical disk is a VVOL.
- Bound VVOL List(h): Logical disk numbers of bound VVOLs. They are displayed only if the specified logical disk is a PE.
- c) Pool group for the auto deploy function  
 For details about how to check a pool group for the auto deploy function, see the following iSM documentation:  
 Command Reference > Auto Deploy Function > Checking a Pool Group

### 3.1.3 Displaying VVOL-Related Resources on the vSphere Web Client

Following describes how to display VVOL-related resources on the vSphere Web Client.

#### 1. Storage Container/Pool Group for Auto Deploy

On the vSphere Web Client side, a Storage Container/Pool Group for Auto Deploy is displayed as a VVOL Datastore. On the datastore list screen, basic information about VVOL datastores is displayed. On the Datastore Manage screen ([Settings] tab), detailed information about VVOL datastores and the mapping information on the storage side are displayed.

##### a) Datastore list screen

On the list screen, basic information about datastores (such as the Status, Capacity, and Type) is displayed. The type of datastores related to Storage Container/Pool Group for Auto Deploy is VVOL.

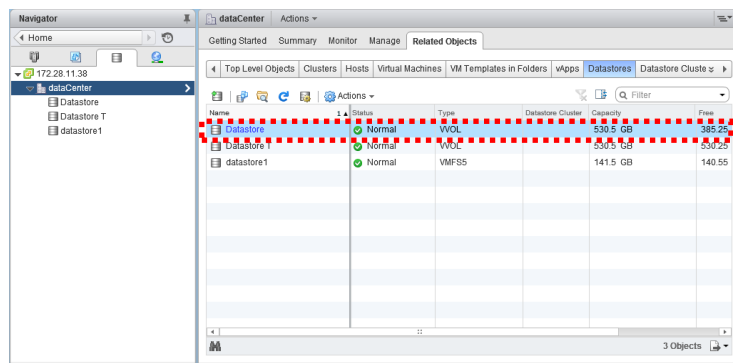

Figure 3-13 Datastore List

b) Manage → Settings screen

Mapping with the storage side can be determined from the [UUID] and [Storage array(s)] under Backing Storage Container on the Datastore Manage screen ([Settings] tab).

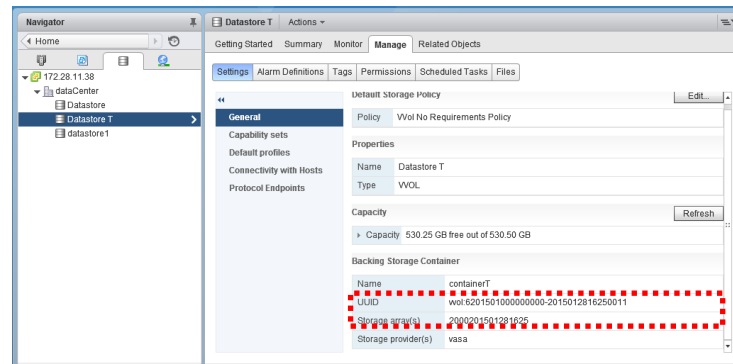

Figure 3-14 Datastore Manage screen ([Settings] Tab)

UUID: vvol:6xxxxxx00000000w-yyyzyzyzyzyzyzzzz

x: 5th to 10th digits of the WWN of the storage. Hexadecimal notation.

y: Last 12 digits of the WWN of the storage. Hexadecimal notation.

z: Pool or pool group number. Hexadecimal notation.

w: A Flag to distinguish a pool or pool group

1: Pool group

0: Pool

Storage array: Disk array name.

## 2. VVOL Information

On the vSphere Web Client side, a vmdk-VVOL is the hard disk of a virtual machine.

Mapping with a config-VVOL of the storage side can be determined from the disk file display of the hard disk on the virtual machine Edit Settings screen.

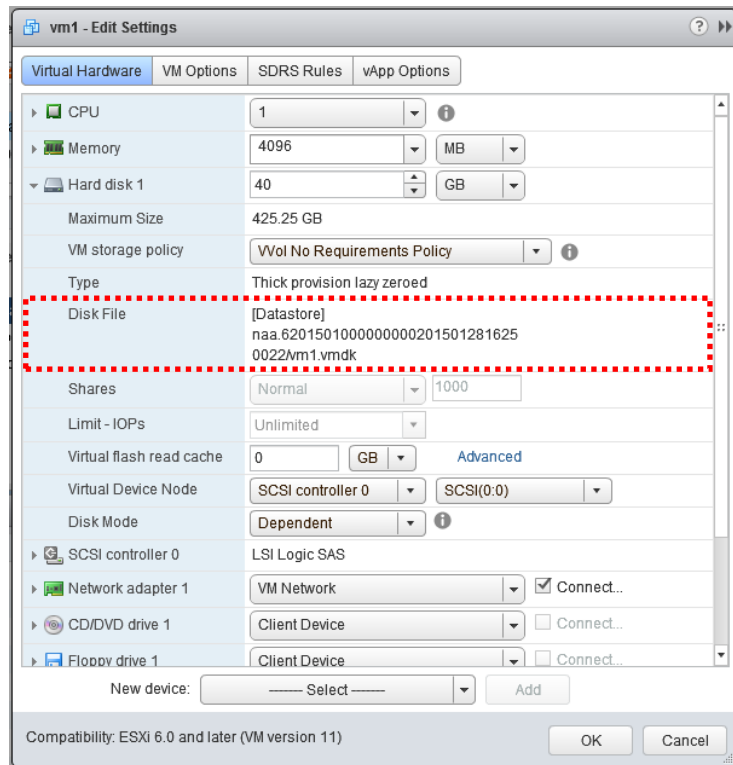

Figure 3-15 Virtual Hard Disk

Disk File: [ssss] naa.6xxxxxx000000000yyyyyyyyyyyyzzzz/???.vmdk

- s: Datastore name
- x: 5th to 10th digits of the WWN of the storage. Hexadecimal notation.
- y: Last 12 digits of the WWN of the storage. Hexadecimal notation
- z: Logical disk number. Hexadecimal notation
- ???: Disk array file name

Since information about a swap-VVOL and memory-VVOL is not displayed on the vSphere Web Client side, check this information on the iSM side.



### 3. Protocol Endpoint

On the vSphere Web Client side, a resource is displayed as a Protocol Endpoint on the [Manage → Storage] tab. Mapping with the storage side can be determined from the identifier display.

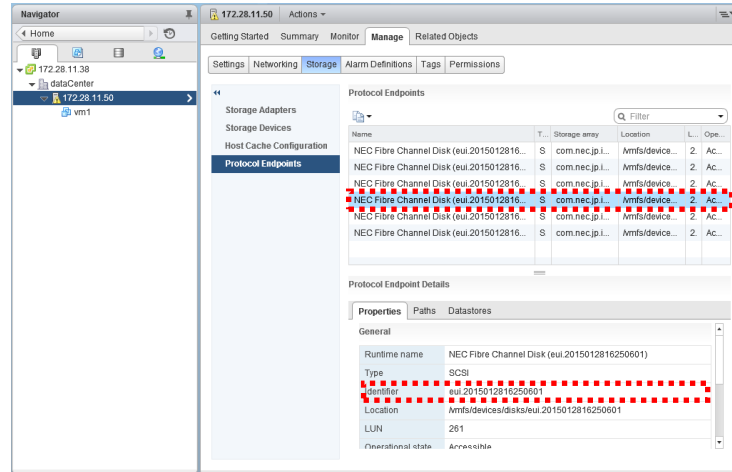

Figure 3-16 Host Management Screen ([Storage] Tab)

Identifier: eui.xxxxxxxxxxxxxxyyy

x: Last 12 digits of the WWN of the storage. Hexadecimal notation

y: Logical disk number. Hexadecimal notation

## 3.2 Adding and Deleting a Datastore

---

Select a VVOL type to add a datastore in a Virtual Volume environment.

### 3.2.1 Adding a Datastore

---

The procedure for adding a Storage Container is as described below.

1. On the storage side, create a Storage Container or pool group for the auto deploy function.  
For more information about how to create a Storage Container, refer to “Setup” > “Creating and Deleting a Storage Container.” For more information about how to create a pool group for the auto deploy function, refer to the following iSM documentation:  
Command Reference > Auto Deploy Function > Creating and Operating an Auto Deploy Environment  
After creating a Storage Container or pool group for the auto deploy function, be sure to rescan the storage provider. For details about how to rescan the storage provider, refer to the following VMware documentation:  
ESXi and vCenter Server 6.0 Documentation > vSphere Storage > Using Storage Providers > Update Storage Providers
2. On the vSphere Web Client side, create a VVOL datastore. For details about creating a VVOL datastore, refer to the following VMware documentation:  
ESXi and vCenter Server 6.0 Documentation > vSphere Storage > Working with Datastores > Creating Datastores



A Storage Container supports a virtual capacity pool only.



A pool group for the auto deploy function to be used on a Virtual Volume environment must consist of two Storage Container pools.

## 3.2.2 Deleting a Datastore

Before deleting a Storage Container, be sure to check on both vCenter and iSM that deleting it does not present any problems. On the vCenter side, check that there is no virtual machine using the Storage Container. On the iSM side, confirm that a system volume such as a solution reserved volume can be deleted; that is, that no logical disk exists for snapshots (EBV and ESV) and Fast Clone (FEV and FCV). If there are no problems, delete a Storage Container by using the procedure below.

**Reference:**

- EBV refers to an Extended Base Volume that is a base-volume to be used in the extended snapshot function.
- ESV refers to an Extended Snapshot Volume that is a snapshot acquired by the extended snapshot function.
- FEV refers to a Fast clone Entity Volume that is a logical disk to be used as the master of a volume cloning.
- FCV refers to a Fast Clone Volume that is a clone logical disk of FEV.

1. On the vSphere Web Client side, unmount the datastore. For details about how to unmount the datastore, refer to the following VMware documentation:  
ESXi and vCenter Server 6.0 Documentation > vSphere Storage > Working with Datastores > Administrative Operations for Datastores > Unmount Datastores
2. On the storage side, delete the pool or the pool group for the auto deploy function corresponding to the datastore. Use the `iSMcfg poolunbind` command to delete a pool corresponding to the Storage Container. For more information about the `iSMcfg poolunbind` command, refer to the following iSM documentation:  
Command Reference > Reference > Command Reference > Configuration Setting Commands > `iSMcfg poolunbind`  
For more information about how to delete a pool group for the auto deploy function, refer to the following iSM documentation:  
Command Reference > Functions > Auto Deploy Function > Creating and Operating an Auto Deploy Environment

## 3.3 Adding and Deleting a Virtual Machine

---

Adding a virtual machine in a Virtual Volume environment requires selecting a VVOL datastore. The method of adding or deleting a virtual machine in a Virtual Volume environment is the same as the method of adding or deleting a machine in a VMFS environment.

### 3.3.1 Adding a Virtual Machine

---

Use the following procedure to add a virtual machine:

1. Create a VVOL datastore. For details, refer to 3.2.1 “Adding a Datastore.”
2. On the vSphere Web Client side, adding a virtual machine to a VVOL datastore is adding a virtual machine. For details about how to add a virtual machine, refer to the following VMware documentation:  
[ESXi and vCenter Server 6.0 Documentation > vSphere Virtual Machine Administration > Deploying Virtual Machines > Create a Virtual Machine Without a Template or Clone](#)

### 3.3.2 Deleting a Virtual Machine

---

On the vSphere Web Client side, deleting a virtual machine from a VVOL datastore is deleting a virtual machine.

For details about how to delete a virtual machine, refer to the following VMware documentation:

[ESXi and vCenter Server 6.0 Documentation > vSphere Virtual Machine Administration > Managing Virtual Machines > Adding and Removing Virtual Machines > Remove Virtual Machines from the Datastore](#)

## 3.4 Adding and Deleting a Server

Following describes the procedures to add or delete a server.

### 3.4.1 Adding a Server

Before adding a server, install an ESXi server and connect it to the storage device. Add an ESXi server by using the procedure below, so that it does not affect the existing environment.

1. Register the ESXi server on vCenter Server.

For details about the operation, refer to the following VMware documentation:

ESXi and vCenter Server 6.0 Documentation > vCenter Server and Host Management >  
Organizing Your Inventory > Add a Host

2. Register the ESXi server in the storage device.

Set Access Control so that the existing PEs can also be recognized from the new ESXi server. For details about the operation, refer to “Setup” > “Setting up a Disk Array” > “Creating and Deleting a Protocol Endpoint.

### 3.4.2 Deleting a Server

The procedure for deleting an ESXi server is as described below.

1. From vCenter Server, delete a managed ESXi server. For details about the operation, refer to the following VMware documentation:

ESXi and vCenter Server 6.0 Documentation > vCenter Server and Host Management >  
Managing Hosts in vCenter Server > Remove a Host from a Cluster

- \* Deleting a managed host from vCenter Server does not delete the virtual machines from the managed host or datastore. This merely deletes the managed host and the access right of vCenter Server to the virtual machines on that host.

2. On the storage side, delete the access control settings related to the ESXi server. As with a normal logical disk, deallocate the PE from the ESXi host. For more information about the procedure, refer to the section “iSMcfg delldsetld” in the “Command Reference.”

## 3.5 Expanding the Capacity of a Disk Array

If the capacities of VVOL datastores and virtual disks in the Virtual Volume environment become insufficient, their capacities can be expanded.

### Expanding the capacity of a VVOL datastore

1. On the storage side, use the `iSMcfg poolexpand` command to expand the capacity of the target Storage Container. For more information about the procedure, refer to the section “iSMcfg poolexpand” in the “Command Reference.”
2. On the vSphere Web Client side, select the target datastore, and update the capacity information.

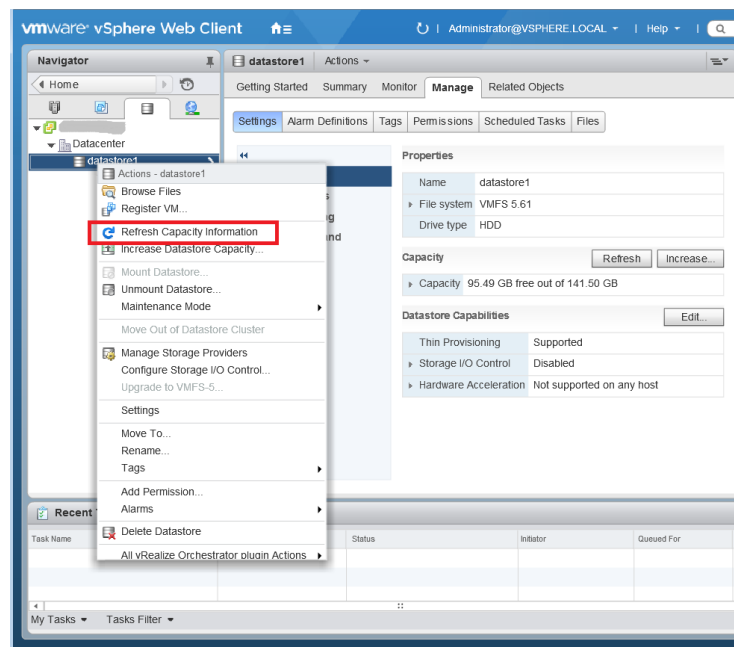

Figure 3-17 Updating Capacity Info

### Expanding a virtual disk

The method used to expand a virtual disk in a Virtual Volume environment is the same as the method used to expand a virtual disk in a VMFS environment. For details about the operation, refer to the following VMware documentation:

ESXi and vCenter Server 6.0 Documentation > vSphere Virtual Machine Administration > Configuring Virtual Machine Hardware > Virtual Disk Configuration > Change the Virtual Disk Configuration



If expansion of a virtual disk to which a backup policy is applied has failed, its backup volume might have been expanded. Check whether the backup volume has been successfully expanded or not on the vSphere Web Client alarm window.

For the meaning of and action for the alarm, see the messages “Failed to expand the volume (But had succeed in expanding backup volume. Target capacity:<aaa...a>).” and “Failed to expand the second backup volume (backup volume:<aaa...a>, capacity:<bbb...b>).” in “Appendix B Messages.”



If the actual capacity of a Storage Container (pool) that has been created as a virtual capacity pool becomes insufficient, an I/O error occurs while data is being written to the disk array, stopping the operation. Therefore, it is necessary to monitor the disk array so that the amount of data to be written to the disk array unit no longer exceeds the actual capacity of a Storage Container. Use iSM to monitor the capacity of a virtual capacity pool and to take appropriate action in case of a shortage of the actual capacity. For details, refer to the “Thin Provisioning User’s Manual.”

## 3.6 Migrating a Virtual Machine

---

To implement to migrate a virtual machine, “change the host,” “change the datastore,” and “change the host and the datastore” can be select.

Migrating a virtual machine between datastores uses DynamicDataReplication, meaning that the DynamicDataReplication license be unlocked on the storage side. For details about the operation, refer to “Disk Array” in the “Configuration Setting Tool User’s Manual (GUI) for the M Series.”

Also, a datastore to which to migrate the virtual machine is necessary. For details, refer to “Basic Operations” > “Adding and Deleting a Datastore” > “Adding a Datastore.”

The method used to migrate a virtual machine in a Virtual Volume environment is the same as the method used to migrate a virtual machine in a VMFS environment. For details about the operation, refer to the following VMware documentation:

ESXi and vCenter Server 6.0 Documentation > vCenter Server and Host Management > Migrating Virtual Machines > Migrate a Virtual Machine to New Storage



When a virtual machine to which a backup policy is applied is migrated to a different datastore, the same backup volume configuration can also be migrated by specifying the same backup policy.

Note the following on performing this operation:

- When a virtual machine is migrated to a different datastore, the backup volume of the source datastore cannot be used. Therefore, it is necessary to create a new backup volume. By selecting [No] for [Backup Volume Automatic Deleted] in the backup policy, backups before migration can be kept.
- After migration, a virtual machine can be backed up by using a backup tool. However, since a full copy is performed in the first backup, it takes time to complete backup. If there are two backup generations, a full copy is also performed in the second backup.



## 3.7 Creating and Deleting a Snapshot of a Virtual Machine

To implement a snapshot of a virtual machine in a Virtual Volume environment, the snapshot function can be used on the storage side.

### 3.7.1 Using the Snapshot Function

To create a snapshot of a virtual machine in a Virtual Volume environment, the snapshot function of the disk array is used. This snapshot function has been enhanced to cooperate with the volume clone function for a Virtual Volume environment. The snapshot function to be used in a Virtual Volume environment is called the “extended snapshot function” to distinguish from the conventional snapshot function.

The extended snapshot function is available only for a virtual volume.

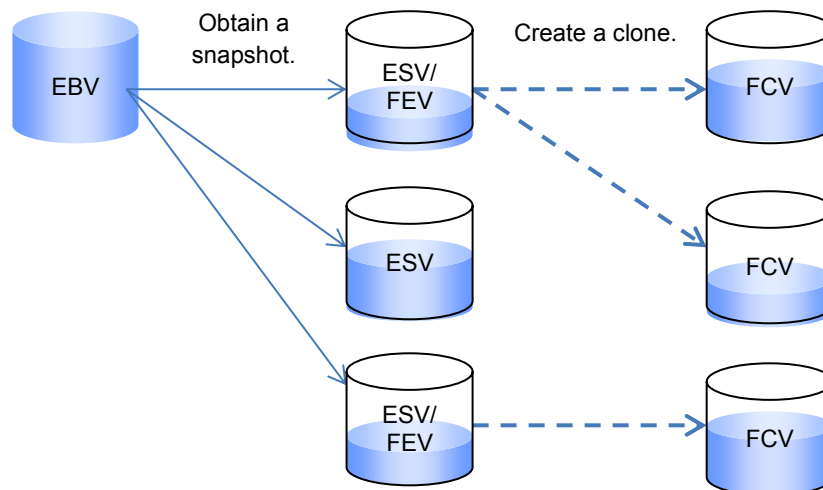

- EBV (Extended Base Volume): Base volume used by the extended snapshot function
- ESV (Extended Snapshot Volume): Snapshot obtained by the extended snapshot function
- FEV (Fast clone Entity Volume): Logical disk that is a master of a volume cloning
- FCV (Fast Clone Volume): Clone logical disk created from an FEV

Figure 3-18 Overview of Extended Snapshot

An FEV and FCV are a logical disk to be used by the volume clone function. For details about the volume clone function, refer to 3.8.1 “Using the Volume Clone Function.”

To use the extended snapshot function, a solution reserved volume (SSV) needs to be created, but creation of SRA is unnecessary. The component names of the extended snapshot function that are displayed in the iSM client and configuration display command (`ismview`) differ from those of the conventional snapshot

function for distinction. Table 3-1 shows the name correspondence of each component. For details about snapshot components, refer to the “Snapshot User’s Manual (Function Guide).”

Table 3-1 Component Name Correspondence the Conventional Snapshot and Extended Snapshot

Component	Name Used in the Conventional Snapshot	Name Used in the Extended Snapshot
Base-volume that is a source of a snapshot	BV	EBV
Snapshot volume created from a base-volume	SV	ESV
Virtual volume to establish connection and access between a base-volume and snapshot volume	LV	LV (Common)
Volume to be used to control a disk array	CV	CV (Common)
Area to hold differential data of snapshot volumes	SRA	(Unnecessary)
Logical disk to configure SRA	SDV	(Unnecessary)
Logical disk to be used for internal control of a disk array	(Unnecessary)	SSV



Up to 256 snapshot generations can be created from one base-volume.

## 3.7.2 Creating a Snapshot of a Virtual Machine

To use the extended snapshot function of the disk array in a Virtual Volume environment, the following preparations must be performed on the disk array.

### Prerequisites

- The snapshot (DynamicSnapVolume) and thin provisioning (ThinProvisioning) licenses have been unlocked on the storage side. For details about how to unlock the license, refer to “Configuration Setting Tool User’s Manual (GUI) for the M Series” > “Disk Array” > “Unlock License.”
- A solution reserved volume has been created. Create a solution reserved volume according to “Setup” > “Setting up a Disk Array” > “Creating and Deleting a Solution Reserved Volume.”
- For the M120, M320, and M320F disk arrays, it is necessary to create an SRA. For more information about how to create an SRA on a VVOL environment, refer to “Setup” > “Setting up a Disk Array” > “Creating and Deleting a Snapshot Reserve Area” > “2.1.5.1 Creating an SRA.”

### Procedure

The method used to create a snapshot of a virtual machine in a Virtual Volume environment is the same as the method used to create a snapshot of a virtual machine in a VMFS environment. For details about the operation, refer to the following VMware documentation:

ESXi and vCenter Server 6.0 Documentation > vSphere Virtual Machine Administration > Managing Virtual Machines > Using Snapshots To Manage Virtual Machines > Taking Snapshots of a Virtual Machine



The maximum number of snapshots that can be created for a virtual machine is restricted. For the maximum number of snapshots on VMware, refer to the following VMware documentation:

ESXi and vCenter Server 6.0 Documentation > vSphere Virtual Machine Administration > Managing Virtual Machines > Using Snapshots To Manage Virtual Machines

For a disk array, up to 255 snapshots of a virtual machine can be created.

## 3.7.3 Deleting a Snapshot of a Virtual Machine

The method of deleting a snapshot of a virtual machine in a Virtual Volume environment is the same as the method of deleting a snapshot of a virtual machine in a VMFS environment. For details about the operation, refer to the following VMware documentation:

ESXi and vCenter Server 6.0 Documentation > vSphere Virtual Machine Administration > Managing Virtual Machines > Using Snapshots To Manage Virtual Machines > Deleting Snapshots

## 3.8 Creating a Clone of a Virtual Machine

To create a clone of a virtual machine in a Virtual Volume environment, use the data replication function and volume clone function of the disk array.

For details about the replication function, refer to the “Data Replication User’s Manual (Function Guide).”

### 3.8.1 Using the Volume Clone Function

The volume clone function of the disk array can create a clone logical disk that has the same data as the original.

A clone created by the volume clone function is a virtual capacity logical disk that internally holds the difference from the original. This enables to create a clone at the shortest, as well as to maintain the created clone by using the minimum physical disk.

The created clone logical disk is called a “Fast Clone” because it is created in a short time, distinguishing from other logical disks.

Multiple clones can be created. Since the created clones can be treated as an independent logical disk, they can be used in different operations. They do not interfere each other.

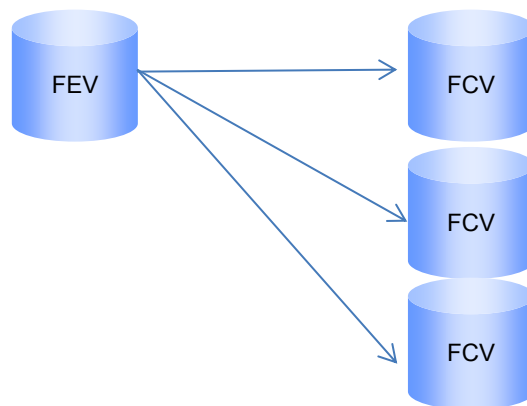

FEV (Fast clone Entity Volume): Logical disk that is a master of a volume cloning  
FCV (Fast Clone Volume): Clone logical disk created from an FEV

Figure 3-19 Overview of Fast Clone



Up to 256 clone logical disks can be created from one logical disk.

## 3.8.2 Creating a Clone of a Virtual Machine

To use the data replication and volume clone functions of the disk array in a Virtual Volume environment, the following preparations must be performed on the disk array.

### Prerequisites

- The dynamic data replication (DynamicDataReplication) and volume clone (Volume Clone) licenses have been unlocked on the storage side. For details about how to unlock the license, refer to “Configuration Setting Tool User’s Manual (GUI) for the M Series” > “Disk Array” > “Unlock License.”
- A solution reserved volume has been created. Create a solution reserved volume according to “Setup” > “Setting up a Disk Array” > “Creating and Deleting a Solution Reserved Volume.”
- For the M120, M320, and M320F disk arrays, it is necessary to create an SRA. For more information about how to create an SRA on a VVOL environment, refer to “Setup” > “Setting up a Disk Array” > “Creating and Deleting a Snapshot Reserve Area” > “2.1.5.1 Creating an SRA.”

### Procedure

- The method of creating a clone of a virtual machine in a Virtual Volume environment is the same as the method of creating a clone of a virtual machine on the vSphere Web Client. For details about the operation, refer to the vSphere Web Client operation method.
- Fast Clone of a virtual machine in a Virtual Volume environment is “linked clone” on the vSphere. For details about the operation, refer to the following VMware documentation:  
ESXi and vCenter Server 6.0 Documentation > vSphere Virtual Machine Administration > Deploying Virtual Machines > Clone a Virtual Machine



A clone of the virtual machine clone can be created. Taking the first clone creation as a first layer, up to 64 layers of clones can be created. In addition, a clone can be created from a snapshot in a virtual machine, and a snapshot can be created from a snapshot. In this creation, taking the snapshot creation as a first layer, up to 64 layers of clones can be created.



Before creating a “linked clone”, ensure that the target Storage Container has enough free space.



Since a “linked clone” does not support a pool group for the auto deploy function, a fast clone of a virtual machine cannot be created in the datastore that consists of a pool group for the auto deploy function.

## 3.9 Policy-Based Allocation

---

In creating a virtual machine, it is possible to narrow down appropriate datastores (Storage Containers) in accordance with a policy. In creating a new virtual machine storage policy, the utilization options of the following storage solutions can be set.



If you want to set storage functions, select [com.nec.jp.ism.vasaprovider] for [Rules based on data services] when creating a virtual machine storage policy.

### Performance

- Physical Disk Type  
A physical disk type can be set.

### RAID

- RAID  
A RAID type can be set.

### Security

- Specify Encrypt PD  
A utilization option of an encrypt PD can be set.

### Backup

- Enable Backup  
Specify whether or not to back up a virtual machine.
- Backup Volume Automatic Deleted  
Specify whether or not to delete a backup volume of a virtual machine when deleting the virtual machine.
- The Number of Backup Generations  
Specify the number of backup volume generations.

### I/O Control

- Enable I/O Upper Control  
An option of Storage Container I/O upper control can be set.
- Enable I/O Lower Control  
An option of Storage Container I/O lower control can be set.
- I/O Upper Control Limit (IOPS)  
This is enabled by selecting [Yes] for [Enable I/O Upper Control].

- I/O Lower Control Limit (IOPS)

This is enabled by selecting [Yes] for [Enable I/O Lower Control].



To apply a policy to a pool group for the auto deploy function, create a pool group by using Storage Containers that have the same attributes such as the physical disk type, RAID type, and I/O Control settings.

## 3.9.1 Defining a Backup Policy

When backing up a VVOL, define a backup policy before adding a virtual machine. The procedure to define a backup policy is shown below:

1. From the vSphere Web Client Home, select [VM Storage Policies] and click the [Create a New VM Storage Policy] icon. For details about the operation, refer to the following VMware documentation:  
 ESXi and vCenter Server 6.0 Documentation > vSphere Storage > Virtual Machine Storage Policies > Creating and Managing VM Storage Policies > Define a Storage Policy for a Virtual Machine > Start VM Storage Policy Creation Process
2. Select [com.nec.jp.ism.vasaprovider] from the [Rules based on data services] drop-down list.

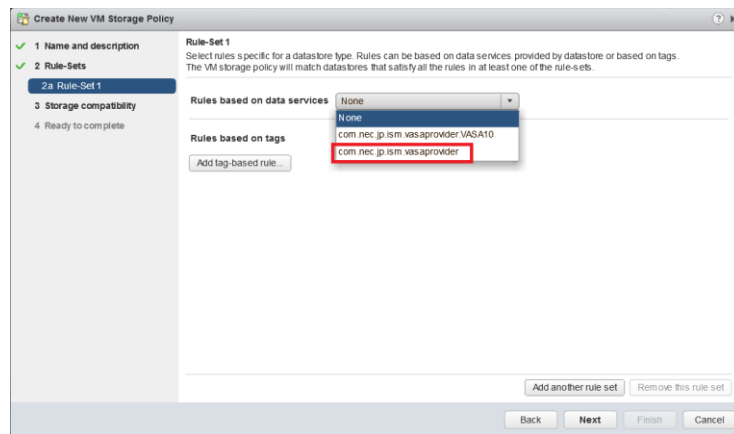

Figure 3-20 Selecting Rules Based on Data Services

3. Select [Backup] from the [<Add rule>] drop-down list.

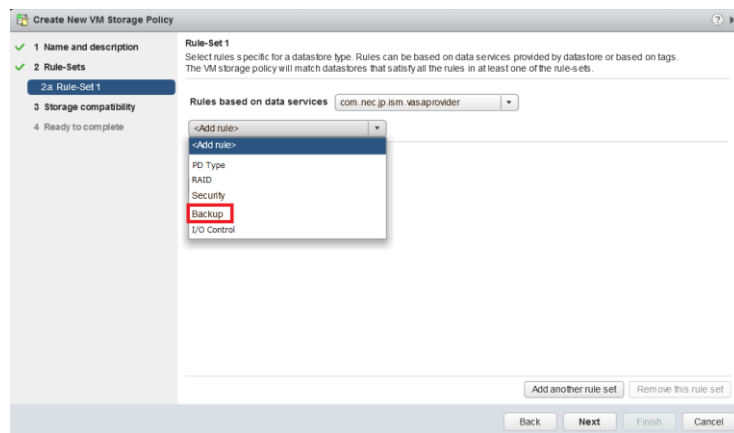

Figure 3-21 Adding Backup Rules



## 4. Specify the following:

- Enable Backup

Specify whether or not to back up a virtual machine. Select [Yes] to create a backup volume when creating a virtual machine.

- Backup Volume Automatic Deleted

Specify whether or not to automatically delete a backup volume of a virtual machine when deleting the virtual machine.

Select [Yes] to delete the backup volume.

- The Number of Backup Generations

Select the number of backup volume generations.

When [1] is selected, one generation of a backup volume is created for a virtual disk.

When [2] is selected, two generations of backup volumes are created for a virtual disk.

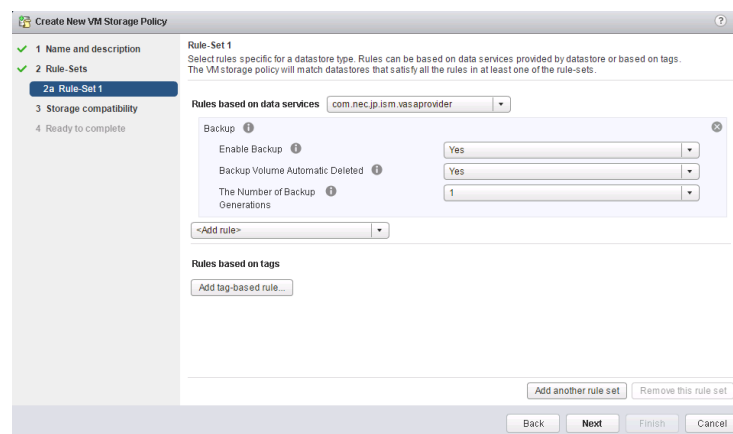

Figure 3-22 Setting Backup Rules

After changing the pool name, be sure to rescan the storage provider. For details about the operation, refer to the following VMware documentation:

ESXi and vCenter Server 6.0 Documentation > vSphere Storage > Using Storage Providers > Update Storage Providers



The policy whose number of generations is small cannot be applied to the virtual machine or virtual disk to which the backup policy has been applied.

For example, the policy whose [Backup] is set to [No] cannot be applied to the virtual disk to which the policy whose [Number of backup volume generations] is 1 has been applied.

Also, the policy whose [Number of backup volume generations] is 1 cannot be applied to the virtual disk to which the policy whose [Number of backup volume generations] is 2 has been applied.

To enable these policy applications, delete the RV created as a backup volume by using iSM.

When decreasing the number of backup volume generations from 2 to 1, delete either of the existing volumes (either of them can be deleted).

After deleting the RV, apply the policy that is compatible with the number of remaining RVs.

For the virtual disk to which the policy whose [Number of backup volume generations] is 2 has been applied, after deleting either of the two RVs created in it, apply the policy whose [Number of backup volume generations] is 1.

You can confirm that the correspondence between backup volumes and RVs and the date when the RVs have been backed up on the Virtual Volume VM backup information screen.

For details, see F.3 “Virtual Volume VM Backup Information Screen.”

To increase the number of backup volume generations, apply the policy again.



The backup function creates a logical disk for backup (backup volume (RV)) in the Storage Container whose pool name begins with `vvolbackup`. `vvolbackup` must be in lower-case.

Therefore, before adding a virtual machine, create a Storage Container by specifying a pool name beginning with `vvolbackup`. `vvolbackup` must be in lower-case.



When you select [Yes] for [Backup Volume Automatic Deleted], ensure that the backup volume is not allocated to an LD Set when deleting a virtual machine.



When the disk array contains only one pool that uses the backup function (a Storage Container whose pool name begins with `vvolbackup`), if a storage policy in which [2] is selected for [Backup Volume Generations] is applied, two generations of backup volumes will be created in the same backup pool. In this case, the following alarm message is displayed on vSphere Web Client.

```
The disk array has only one pool for backup.
```



Even though you apply the backup policy for the VM which is created by link clone, no backup volume can be created. In this case, the following alarm message may be displayed:

```
Backup can not be done for linked clones.
```



When a virtual machine to which a backup policy is applied is migrated to a different datastore, the same backup volume configuration can also be migrated by specifying the same backup policy.

Note the following on performing this operation:

- When a virtual machine is migrated to a different datastore, the backup volume of the source datastore cannot be used. Therefore, it is necessary to create a new backup volume. By selecting [No] for [Backup Volume Automatic Deleted] in the backup policy, backups before migration can be kept.
- After migration, a virtual machine can be backed up by using a backup tool. However, since a full copy is performed in the first backup, it takes time to complete backup. If there are two backup generations, a full copy is also performed in the second backup.

## 3.9.2 Defining an I/O Control Policy

When performing I/O control, define the I/O Control policy before adding a virtual machine.

The procedure to define the I/O Control policy is shown below:

1. From the vSphere Web Client Home, select [VM Storage Policies] and click the [Create a New VM Storage Policy] icon. For details about the operation, refer to the following VMware documentation:  
ESXi and vCenter Server 6.0 Documentation > vSphere Storage > Virtual Machine Storage Policies > Creating and Managing VM Storage Policies > Define a Storage Policy for a Virtual Machine > Start VM Storage Policy Creation Process
2. Select [com.nec.jp.ism.vasaprovider] from the [Rules based on data services] drop-down list.
3. Select [I/O Control] from the [<Add rule>] drop-down list.

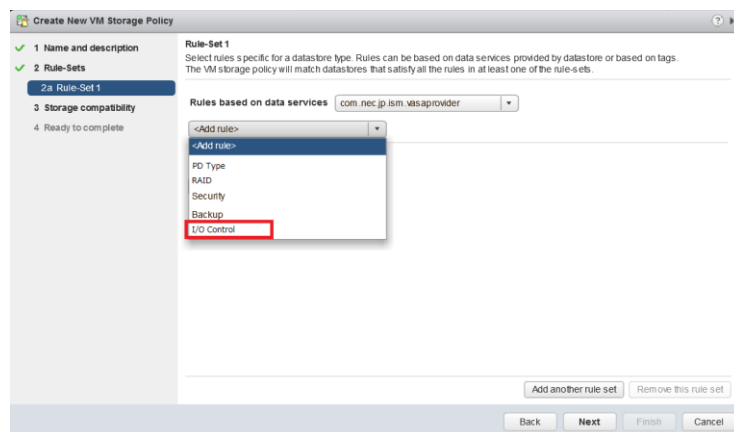

Figure 3-23 Adding I/O Control Rules

4. Specify the following:
  - Enable I/O Upper Control  
Specify whether to perform I/O upper control for a Storage Container.  
Select [Yes] to enable I/O upper control when a virtual machine is created.
  - Enable I/O Lower Control  
Specify whether to perform I/O lower control for a Storage Container.  
Select [Yes] to enable I/O lower control when a virtual machine is created.
  - I/O Upper Control Limit (IOPS)  
Specify the I/O upper limit. This option is enabled by selecting [Yes] for [Enable I/O Upper Control]. The unit is IOPS. A decimal value within 10 to 1000000 can be specified.
  - I/O Lower Control Limit (IOPS)  
Specify the I/O lower limit. This option is enabled by selecting [Yes] for [Enable I/O Lower Control]. The unit is IOPS. A decimal value within 10 to 1000000 can be specified.

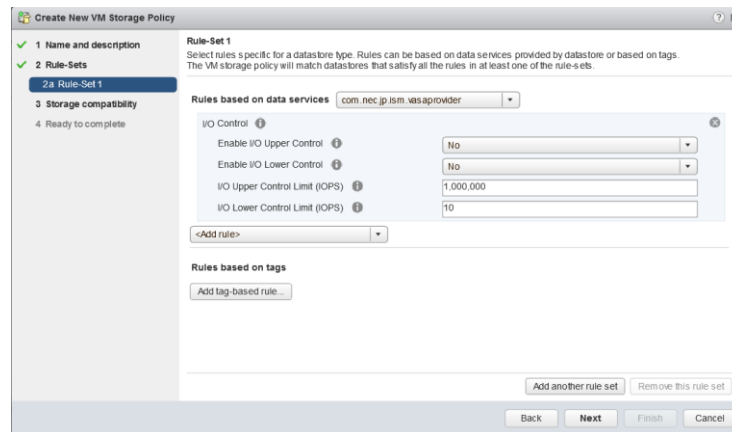

Figure 3-24 Setting I/O Control Rules



The I/O lower limit must be less than the I/O upper limit.

I/O control for a pool must be set on the storage side. For details about the operation, refer to “Configuring the I/O Control Settings” in the “I/O Control User’s Manual.”

Enable the I/O upper limit setting and I/O lower limit setting if necessary.

After changing the I/O control setting for a pool, be sure to rescan the storage provider. For details about the operation, refer to the following VMware documentation:

ESXi and vCenter Server 6.0 Documentation > vSphere Storage > Using Storage Providers > Update Storage Providers

### 3.9.3 Assigning a Storage Policy to a Virtual Machine

For details about the operation to assign a storage policy to a virtual machine on the vSphere Web Client side, refer to the following VMware documentation:

ESXi and vCenter Server 6.0 Documentation > vSphere Storage > Virtual Machine Storage Policies > Storage Policies and Virtual Machines > Assign Storage Policies to Virtual Machines

## 3.10 Adding a Storage Device

---

Add a storage device by using the procedure below, so that it does not affect the existing environment.

### Prepare VASA Provider

1. Register the storage device to be added to VASA Provider.  
For details about this operation, refer to “Setup” > “Setting up a Disk Array” > “Creating and Deleting a Storage Container.”

### Set up the Virtual Volume environment in the storage device

1. Create a Storage Container or a pool group for the auto deploy function.  
For details about how to create a Storage Container, refer to “Setup” > “Maintenance of VASA Provider” > “Modification of Settings” > “Registering/Unregistering a disk array.” For how to create a pool group for the auto deploy function, refer to “Command Reference” > “Auto Deploy Function” > “Configuring and Operating an Auto Deploy Environment.”
2. Create a solution reserved volume.  
For details about this operation, refer to “Setup” > “Setting up a Disk Array” > “Creating and Deleting a Solution Reserved Volume.”
3. Create a PE.  
For details about this operation, refer to “Setup” > “Setting up a Disk Array” > “Creating and Deleting a Protocol Endpoint.”
4. Allocate the PE to an ESXi server.  
For details about this operation, refer to “Setup” > “Setting up a Disk Array” > “Creating and Deleting a Protocol Endpoint.”

## Chapter 4 VVOL Operation Using Storage Functions

### 4.1 Backup Operation

It is possible to apply the data replication function to logical disks used in VVOL operation, as with normal logical disks, and perform backup operations.

In an environment in which multiple VMDK files are created on the same logical disk, multiple virtual machines (VMs) share a single logical disk. In this configuration, data replication in VM units can be performed with the ESXi server functions, but it cannot be performed with the data replication function of the disk array. In an environment using VVOLs, data replication can be performed in VM units by using a disk array function. This enables backup in VM units.

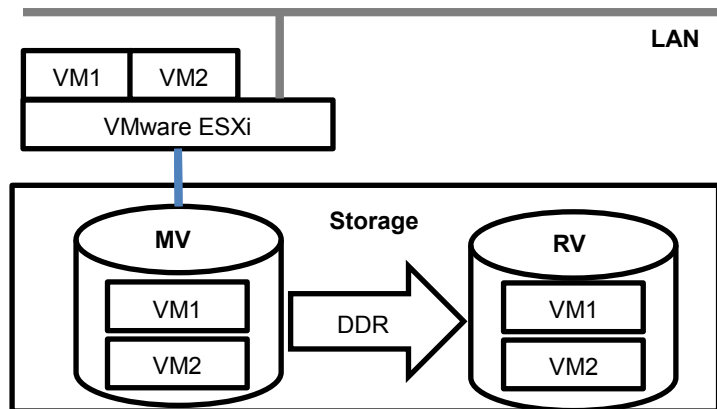

Figure 4-1 Backup in an Environment with Multiple VMs in the Same LD

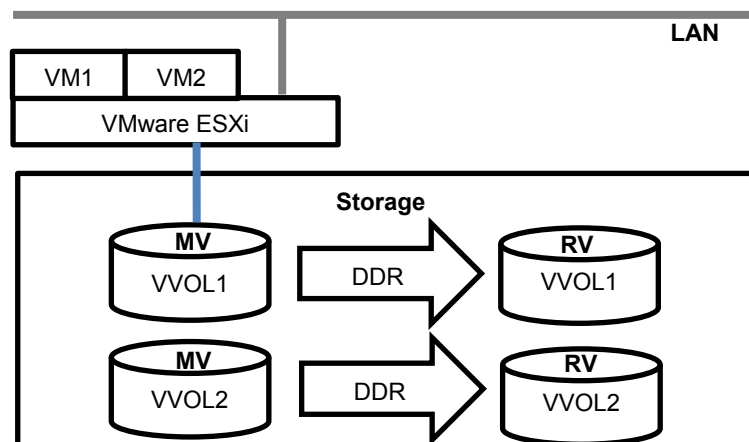

Figure 4-2 Backup in a VVOL Environment

For more information and usage of the data replication function, refer to the “Appendix E Backup Operations and Messages” and the “Data Replication User’s Manual (Function Guide).”

For details about the commands and messages of the backup operation, refer to Appendix E “Backup Operations and Messages.”

And also refer to Appendix A “Notes,” which describes the notes to observe when performing backup operations.

Backup operations cannot be performed for some logical disks used in VVOL operation. The applicability of the function to logical disks with different attributes is shown below.

Table 4-1 Applicability of the Backup Function to Logical Disks Used in VVOL Operation

Attribute	Applicability	Remarks
PE	No	
FEV	No	
FCV	Yes	If the logical disk also has an attribute that denies application of the function, the function cannot be applied.
EBV	Yes	If the logical disk also has an attribute that denies application of the function, the function cannot be applied.
ESV	Yes	If the logical disk also has an attribute that denies application of the function, the function cannot be applied.
Logical disk that does not have any of the above attributes	Yes	



## 4.2 I/O Control Function

It is possible to apply the I/O control function to logical disks used in VVOL operation, as with normal logical disks, and set the upper or lower limit of IOPS (I/O per second).

In an environment in which multiple VMDK files are created on the same logical disk, multiple virtual machines (VMs) share a single logical disk. In this configuration, I/O between VMs as seen from the ESXi server causes competition in the logical disk in the storage device, so it is difficult to achieve I/O Control giving consideration to storage performance. In an environment using VVOLS, it is possible to apply I/O control in VM units with storage functions, thereby achieving I/O Control in VM units.

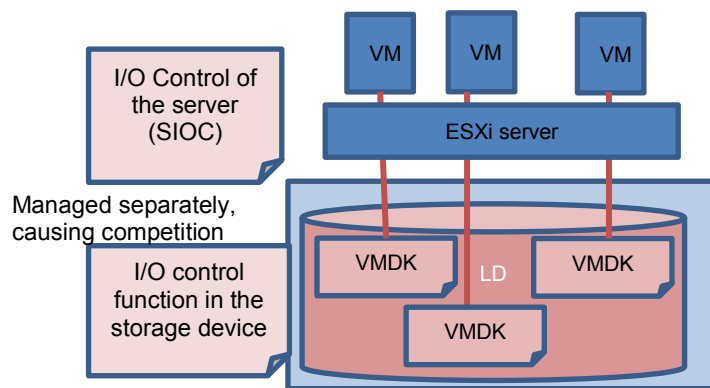

Figure 4-3 I/O Control in an Environment with Multiple VMs in the Same LD

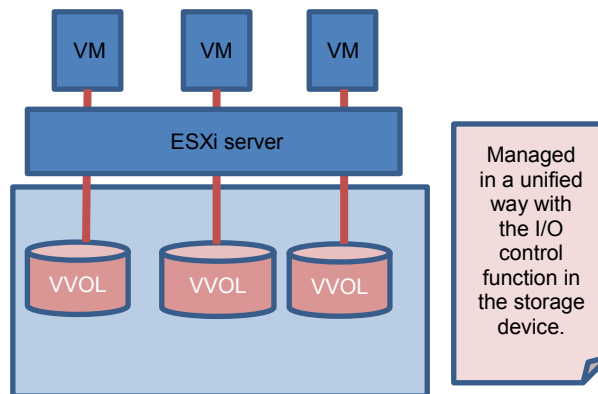

Figure 4-4 I/O Control in a Virtual Volume Environment

With the I/O control function, initial values can be set for the upper and lower limits of IOPS for each pool. This makes it possible to automatically set the upper and lower limits of IOPS when creating VVOLS, preventing errors such as failing to set these.

To change the IOPS upper and lower limit settings, etc., during operation, use iSM. For more information and usage of the I/O control function, refer to the “I/O Control User’s Manual.”

The I/O control function cannot be applied to some logical disks used in VVOL operation. The applicability of the function to logical disks with different attributes is shown below.

Table 4-2 Applicability of the I/O Control Function to Logical Disks Used in VVOL Operation

Attribute	Applicability	Remarks
PE	No	
FEV	Yes	If the logical disk also has an attribute that denies application of the function, the function cannot be applied.
FCV	Yes	If the logical disk also has an attribute that denies application of the function, the function cannot be applied.
EBV	Yes	If the logical disk also has an attribute that denies application of the function, the function cannot be applied.
ESV	No	
Logical disk that does not have any of the above attributes	Yes	

## 4.3 L2 Cache Function

It is possible to apply the L2 cache function to logical disks used in VVOL operation. It is also possible to change the setting as to whether to apply the L2 cache function to each logical disk. This makes it possible to enable and disable the L2 cache function in VM units, achieving control according to the application of the VM.

To set the L2 cache function, use iSM. For more information and usage of the L2 cache function, refer to the “L2 Cache User’s Manual.”

The L2 cache function cannot be applied to some logical disks used in VVOL operation. The applicability of the function to logical disks with different attributes is shown below.

Table 4-3 Applicability of the L2 Cache Function to Logical Disks Used in VVOL Operation

Attribute	Applicability	Whether the setting can be changed	Remarks
PE	No	No	
FEV	Yes	Yes	
FCV	Yes	Yes	
EBV	Yes	Yes	
ESV	Yes	Yes	
Logical disk that does not have any of the above attributes	Yes	Yes	

## 4.4 Data Allocation Optimization Function

It is possible to automatically place frequently accessed data on high-performance disks and infrequently accessed data on low-performance and low-cost disks in VM units by applying the data allocation optimization function to logical disks used in VVOL operation. This enables effective use of the resources in the entire storage.

To set the data allocation optimization function, use iSM. For more information and usage of the data allocation optimization function, refer to the “Data Allocation Optimization User’s Manual.”

The data allocation optimization function cannot be applied to some logical disks used in VVOL operation. The applicability of the function to logical disks with different attributes is shown below.

Table 4-4 Applicability of the Data Allocation Optimization Function to Logical Disks Used in VVOL Operation

Attribute	Applicability movement between LDs	Applicability to relocation inside an LD	Remarks
PE	No	No	
FEV	No	Yes	If the logical disk also has an attribute that denies data allocation optimization, the function cannot be applied.
FCV	No	Yes	If the logical disk also has an attribute that denies data allocation optimization, the function cannot be applied.
EBV	No	Yes	If the logical disk also has an attribute that denies data allocation optimization, the function cannot be applied.
ESV	No	No	
Logical disk that does not have any of the above attributes	No	Yes	

## 4.5 Performance Monitoring Function and Performance Analysis Function

It is possible to accumulate and check the performance information of logical disks used in VVOL operation by using the performance monitoring function and the performance analysis function. In VVOL operation, performance in VM units can be monitored. With the performance analysis function (PerformanceNavigator), it is possible to display and analyze performance information in VM units.

To set the performance monitoring function, use iSM. For more information and usage of this function, refer to the “Performance Monitoring User’s Manual.” For more information and usage of the performance analysis function, refer to the “Performance Analysis User’s Manual.”

The applicability of the functions to logical disks with different attributes is shown below.

Table 4-5 Applicability of the Performance Monitoring and Performance Analysis Functions to Logical Disks Used in VVOL Operation

Attribute	Performance monitoring	Performance analysis	Remarks
PE	Yes	Yes	
FEV	Yes	Yes	
FCV	Yes	Yes	
EBV	Yes	Yes	
ESV	Yes	Yes	
Logical disk that does not have any of the above attributes	Yes	Yes	

## Chapter 5 Troubleshooting

### 5.1 Collecting Logs

When a failure occurs, collect and provide the following information to the NEC representative for request of investigation.

Item Name	Log Collection Method
Installation log file of VASA Provider	<p>&lt;System driver&gt;:\Users\<user name="">\AppData\Local\Temp\ iSMVASAP.log</user></p> <p>Collect the above files manually.</p> <p>Example: C:\Users\Default\AppData\Local\Temp\iSMVASAP.log</p>
Log files of VASA Provider	<p>&lt;VASA Provider Installation folder&gt;\server\logs\ Collect all files in the above folder manually.</p> <p>Example: C:\Program Files (x86)\NEC\ iSM VASA Provider\server\logs\ </p>
Configuration files of VASA Provider	<p>&lt;VASA Provider Installation folder&gt;\conf\ &lt;VASA Provider Installation folder&gt;\server\conf\ &lt;VASA Provider Installation folder&gt; \server\webapps\iSMvasa\WEB-INF\conf\ Collect all files in the above three folders manually.</p> <p>Example: C:\Program Files (x86)\NEC\ iSM VASA Provider\conf\  C:\Program Files (x86)\NEC\ iSM VASA Provider\server\conf\  C:\Program Files (x86)\NEC\ iSM VASA Provider\ server\ webapps\iSMvasa\WEB-INF\conf\ </p>
iSM fault information	For details, refer to “Information Gathering Method when Server Failure with Unknown Cause (Windows) in the “User’s Manual.”
ESXi host log file	Run the vm-support command to collect logs. The location in which the collected logs are saved is displayed by running this command.
vCenter Server log file	Run the vm-support command to collect logs. The location in which the collected logs are saved is displayed by running this command.
Configuration file (XML file) in which virtual machine information is associated with storage information	<p>&lt;VASA Provider Installation folder&gt;\ RelationBetweenVMandVVOL\ &lt;VASA Provider Installation folder&gt;\ LatestRelationBetweenVMandVVOL\ Collect all files in the above folders manually.</p> <p>Example: C:\Program Files (x86)\NEC\iSM VASA Provider\ RelationBetweenVMandVVOL\  C:\Program Files (x86)\NEC\iSM VASA Provider\ LatestRelationBetweenVMandVVOL\ </p>
Meta data file	<p>&lt;VASA Provider Installation folder&gt;\server\webapps\iSMvasa\WEB-INF\services\metadataFile Collect all files in the above folders manually.</p> <p>Example: C:\Program Files (x86)\NEC\iSM VASA Provider\ server\webapps\iSMvasa\WEB-INF\ services\metadataFile</p>

## 5.2 Troubleshooting

### When the message “No Storage System(0/1 online)” is displayed in the storage provider list on vSphere Web Client

You need to refresh the certificate of the selected storage provider. After refreshing the certificate, be sure to rescan the storage provider.

Click the “Refresh the certificate” icon on the storage provider screen of vSphere Web Client to refresh the certificate. For details about the operation, refer to the following VMware documentation:

ESXi and vCenter Server 6.5 Documentation > vSphere Storage > Using Storage Providers > Refresh Storage Provider Certificates

For details about how to rescan the storage provider, refer to the following VMware documentation:

ESXi and vCenter Server 6.5 Documentation > vSphere Storage > Using Storage Providers > Update Storage Providers

### When invalid rule names are displayed in the [<Add rule>] drop-down list on the policy creation window

Register VASA Provider to vCenter Server again, and then log in to vSphere Web Client again.

- Normal display
  - PD Type
  - RAID
  - Security
  - Backup
  - I/O Control
- Invalid display examples
  - nec.ism.vasaprovider.capabilitymetadata.pd
  - nec.ism.vasaprovider.capabilitymetadata.raid
  - nec.ism.vasaprovider.capabilitymetadata.security
  - nec.ism.vasaprovider.capabilitymetadata.backup
  - nec.ism.vasaprovider.capabilitymetadata.iocontrol

### When Storage Manager shows an error message (iSM07418 or iSM07468), it indicates no free space in the actual pool capacity

Storage Container is created as a virtual capacity pool. Therefore, if the physical disk capacity which constructs the virtual capacity pool became insufficient, it will be unable to write data to the storage system and continue operating the Storage Container. About monitoring a virtual capacity pool and maintenance of insufficient capacity of virtual capacity pool, refer to “Thin Provisioning User’s Manual.”

In this section, it describes supplementary explanation about maintenance method on the assumption in using the Virtual Volume function.

### Step 1: Stopping all businesses

The virtual machine using the insufficient capacity Storage Container will wait for I/O operation and the operating system on the virtual machine will stop working. In this case, if you connect the vSphere Client to the ESXi server, an insufficient capacity and operation failure message will be shown. In the Virtual Volume environment, as the ESXi server restrains I/O operation, it is unnecessary to stop businesses.

### Step 2: Recovering a Storage Container

Recover the fault state by securing the free space. To secure free space, add physical disks, or delete disused virtual machines. In case of using snapshots or clones in the system, executing step4 to secure free space by deleting logical disks for snap-shots or clones. After securing free space, cancel Storage Container alarms by following the instructions of “Insufficient Capacity of Virtual Capacity Pool” in the “Thin Provisioning User’s Manual.”

### Step 3: Resuming some businesses

After securing free space of Storage Container, it will be able to write data again. Businesses will be resumed by using logical disks which are in a normal state. For logical disks, snap-shots, and clones that are in a fault state, repair by the following steps.

### Step 4: Repairing virtual capacity logical disks

Logical disks that have insufficient capacity are displayed in fault state on the Storage Manager. Cancel logical disk alarms by following the instructions of “Insufficient Capacity of Virtual Capacity Pool” in the “Thin Provisioning User’s Manual.” After canceling alarms, connect vSphere Client to the ESXi server and retry I/O to the appropriate logical disks that are in normal state.

In the case of using snap-shots, check the status that is displayed on the Storage Manager and delete all ESVs in fault status that are created from same EBV. To delete snapshots, delete all applicable virtual machine snapshots by operating vSphere Web Client at first. After that, log in to the storage system and execute the following `iSMcfg generationdel` command.

#### [ Syntax ]

```
iSMcfg generationdel {-bvn EBV_Number | -bvname EBV_Name }  
                    -count Number_Of_Generations_To_Delete
```

For more information about the `iSMcfg generationdel` command, refer to “`iSMcfg generationdel`” in the “Command Reference.”

If Storage Container capacity becomes insufficient while creating clones, it remains no information on the vCenter, but it may remain unnecessary logical disks on the storage system. In this case, delete unnecessary logical disks by the following procedures.

- (1) Refer to “unManagerVVOLList” > “actionVVOLList” > “cloningVVOL” on the configuration file (for



more information about configuration file, refer to “Appendix C”), and check all being created clones.

- (2) In the “cloningTime”, it lists the starting time information of the clones being created. Refer to vSphere Web Client > “Home” > “Monitoring” > “Task Console” and check the starting time information of clone creation failure and search for the corresponding record in the configuration file.
- (3) Check the logical disk number in the corresponding record.
- (4) Check the logical disk name of checked logical disk number at step (3) and logical disk name that is paired with it on the Storage Manager.
- (5) Log in to the storage system and forcibly unpair the replication pair by executing the following `iSMrc_separate` and `iSMrc_pair` commands.

**[ Syntax ]**

```
iSMrc_separate -mv master_logical_disk_name -mvflg ld -rv
clone_logical_disk_name -rvflg ld -force all
iSMrc_pair -mv master_logical_disk_name -mvflg ld -rv
clone_logical_disk_name -rvflg ld -unpair
```

- (6) Continuously, execute the following `iSMcfg` command and delete unnecessary logical disks.

**[ Syntax ]**

```
iSMcfg ldunbind -ldn clone_logical_disk_number
```

If there are plural logical disks that failed creating a clone, delete all unnecessary logical disks by repeating (1) to (6) procedures as above.

**Step 5: Restarting VASA Provider**

Restart the VASA Provider. For how to restart the VASA Provider, refer to 2.3 “Maintenance of VASA Provider” > “Restarting VASA Provider.”

**Step 6: Resuming all businesses**

After deleting all fault snap-shots and unnecessary logical disks, new snap-shots and clones can be created again. If necessary, recreate snap-shots and clones.

## Appendix A Notes

### A.1 Notes

- While the disk array configuration is being set by using the iSM client or iSMCLI, an operation for a virtual machine on the datastore might fail. If the operation failed, confirm that the disk array configuration setting has been complete and execute the operation again.
- If you want to migrate a virtual machine, the backup volume that was created by the [Backup] rule will be deleted. Redo the backup after migration if necessary. Note that if [Backup Volume Automatic Deleted] is [No] in the [Backup] rule then the backup volume will not be deleted, but the backup relationship will be released and a new backup volume will be created after migration.
- If you install PathManager whose version does not support Virtual Volume on the ESXi host, the Protocol Endpoint path will become “inactive” and be inaccessible.
- A “linked clone” cannot be created on the VVOL datastore from a virtual machine on the VMFS datastore. Create it from a virtual machine on the VVOL datastore.
- When backing up VVOLs, define a backup policy before adding a virtual machine. If [Yes] is selected for [Enable Backup] of the policy, the environment to back up config-VVOLs and vmdk-VVOLs are created. And then, you can back up config-VVOLs and vmdk-VVOLs by executing backup operation command “onlineBackup.bat” (refer to Appendix E.1 “Backup Operations”).  
When adding a new virtual disk to a virtual machine, select the datastore which is already used by the virtual machine. If not such a datastore is selected for adding a new virtual disk, the added virtual disk cannot be backed up. When you have selected not such a datastore, migrate the virtual disk to the datastore which had been used for the virtual machine by VMware Storage vMotion.
- You cannot create a logical disk whose capacity is less than 1 GB by using the thin provisioning function provided by the disk array. When creating a Virtual Volume on a virtual machine, be sure to specify 1 GB or more for the virtual disk size.  
When less than 1GB is specified as the size of a virtual disk, expand it up to 1GB.
- Warnings and messages from VASA Provider will be output in the Event Console of vSphere Web Client. While using Virtual Volume function, look through these messages in the Event Console appropriately.
- As to deletion of a virtual machine’s snapshot, even if snapshot deletion on vCenter Server has finished, the snapshot deletion process in the disk array may not be completed. It takes some time for this process. Therefore, until completion, make sure not to perform any of the following operations to the virtual machine whose snapshot deletion process is not completed on the disk array:
  - Restoring from a snapshot
  - Creating a snapshot
  - Creating a link clone volume
  - Migrating
- Due to network failure, unnecessary VVOLs may be left without being deleted. Delete unnecessary VVOLs according to A.2 “Deletion of Unnecessary VVOLs”.
- The backup function of a virtual machine for NEC Storage Virtual Volume uses NEC Storage

DynamicDataReplication. Therefore, the backup data is created only in the same disk array as original VVOLs.

- When using an online backup operation for NEC Storage Virtual Volume, note the followings.
  - Only alphanumeric characters can be used for a virtual machine name and a datastore name.
  - If the online backup command `onlineBackup.bat` is forcibly stopped during a backup operation, the backup state might be left as “backing up”. In this case, execute the online backup command again.
  - For Microsoft Windows, the virtual machines of the following operating systems can be backed up.
    - Windows 7 (32-bit/64-bit)
    - Windows 8 (32-bit/64-bit)
    - Windows 8.1 (32-bit/64-bit)
    - Windows Server 2008 (32-bit/64-bit)
    - Windows Server 2008 R2
    - Windows Server 2012
    - Windows Server 2012 R2
  - For Linux, the virtual machines of the following operating systems can be backed up.
    - Linux kernel version 2.6.35-22 or later
  - Make sure that VMware Tools is working normally on the virtual machine.
  - Make sure that the virtual machine name is unique in the data center of a vCenter server.
- Just after changing the configuration, check of configuration will run automatically. Therefore, such a backup operation may take about 10 minutes longer than the case of no configuration change.
- Up to four backup operation commands can be executed in parallel.
- To use the virtual machine backup function, install the following software in the management server.
  - iSM (Ver.9.3 or later)
  - ControlCommand (Ver.9.3 or later)
  - VASA Provider (V2.4.001 or later)
  - VMware vSphere PowerCLI (6.0 or 6.3)/VMware PowerCLI 6.5
- \* To use the virtual machine backup function on the Virtual Volume Management window of VMware vSphere Web Client Plug-in, use VMware vSphere PowerCLI 6.0 Release2 or later.
- \* To use the backup operation commands, use VMware vSphere PowerCLI 6.0 Release1 or later.
- \* After installing PowerCLI, restart the system.
- \* For VMware vSphere PowerCLI (6.0 or 6.3)/VMware PowerCLI 6.5, set up the Windows PowerShell policy following the procedure below. For details, refer to the “PowerCLI User’s Guide.”
  1. Start the PowerCLI Console window (32-Bit) from [Run as administrator].
  2. Run `Set-ExecutionPolicy RemoteSigned` on the PowerCLI Console window (32-Bit).
- \* For VMware PowerCLI 6.5.1, set up the Windows PowerShell policy following the procedure below. For details, refer to the “PowerCLI User's Guide.”
  1. Start the Windows PowerShell Console window (32-bit) from [Run as administrator].
  2. Run `Set-ExecutionPolicy RemoteSigned` on the Windows PowerShell Console

window (32-bit).

\* For the information about the OS supported by PowerCLI, refer to the “PowerCLI User's Guide.”

- The backup operation commands are available only on the management server.
- There are the following upper limits for the concurrent snapshot, clone, link clone, and migration operations.

<b>Disk array</b>	<b>Upper limit for concurrent operations</b>
M110, M310, M310F	16
M510, M710, M710F	32

- The Virtual Volume function cannot be used together with SMI-S Provider.  
Do not use SMI-S Provider when using the Virtual Volume function.  
For SMI-S Provider, refer to the section “Overview of SMI-S Provider” in the “Command Reference.”
- Volumes (Virtual Volume (VVOL)) and Protocol Endpoints (PE) that are used in the Virtual Volume function do not support the power saving function.
  - \* For details about the power saving function, refer to “Power Saving User’s Manual”.
- When you changed the virtual machine name, restart VASA Provider.

## A.2 Deletion of Unnecessary VVOLs

Due to network failure, unnecessary VVOLs may be left without being deleted.

To find unnecessary VVOLs, check the configuration file as follows.

(For details of the configuration file, refer to C.1 “Configuration File.”)

- VVOLs described in `invalidVVOLList` of `unManageVVOLList` are unnecessary because they are not associated with a virtual machine.  
However, VVOLs that are displayed as a file in the datastore file browser are not displayed in `invalidVVOLList` even if they are not used by a virtual machine.
- VVOLs described in `deletingVVOL` of `actionVVOLList` of `unManageVVOLList` are VVOLs that are being deleted.
  - If deletion of the VVOL is not complete on vCenter Server, the VVOL is not unnecessary because it is being deleted.
  - If deletion of the VVOL is complete on vCenter Server, the VVOL may be unnecessary.  
Determine whether the VVOL is necessary or not according to `deletingTime` (indicating the date when the deletion starts).  
In this case, judge whether the VVOL is unnecessary by referring to `deletingTime` (indicating the deletion start time).
- VVOLs described in `cloningVVOL` of `actionVVOLList` of `unManageVVOLList` are VVOLs that are being cloned.
  - If cloning of the VVOL is not complete on vCenter Server, the VVOL is not unnecessary because it is being cloned.
  - If cloning of the VVOL is complete on vCenter Server, the VVOL may be unnecessary.
- VVOLs described in `rvVVOLList` of `unManageVVOLList` are backup VVOLs that were left according to the policy. If these VVOLs will not be used again, they are unnecessary.

The procedure to delete unnecessary VVOLs is described below.

### Procedure

1. Check the information on the logical disk

Run the `iSMview` command to check the type, name, and attributes (snapshot, replication, volume clone) of the logical disk and the list of PEs bound with the logical disk.

Specify the ID of the target logical disk to the parameter `-ln` in the `iSMview` command.

Example:

```
iSMview -ln 10h
+++++
LDN (h)           :          0010
OS Type          :          ← Logical disk type
LD Name          :          00255CDB05310210_FCv0010 ← Logical disk name
```

```

LD Capacity      :      2.0GB(2,147,483,648Bytes)
Pool No.(h)     :      0010
Pool Name       :      iSMcfg_sc_virtual_pool
RaidType        :      RAID1/10
PD Type         :      NLSAS
LD State        :      ready
Capacity Allocation :      virtual
Access Mode     :      ReadWrite
Expansion/
Rearrangement State :      ---
Group           :      Preserve
Purpose         :      Clone
RPL Attribute   :      IV ← Replication attribute
Snapshot Attribute :      BV ← Snapshot attribute
Current Owner   :      00
Default Owner   :      00
Cache Resident  :      no
PD List(h)      :      00-0002,0003
Segment Number(h) :      00
Segment Name    :      DefaultSegment
Read Cache Mode :      on
Write Cache Mode :      on
Configuration Change :
Data Migration State :      ---
Movement State  :      ---
Block Size      :      512byte
Clone Attribute :      FCV ← Volume clone attribute
VMware Type     :      config-VVOL
Bound PE List(h) :      0400,0401
+++++          ↑ List of PEs bound with the target logical disk
  
```

2. Unbind the logical disk from PE(s)

When the logical disk is bound with any PE, run the `iSMcfg pevvolunbind` command to unbind them. Specify the ID of the target PE to the parameter `-peldn` and ID of the target logical disk to the parameter `-vvolldn` in the `iSMcfg pevvolunbind` command.

Example:

```

iSMcfg pevvolunbind -peldn 001fh -vvolldn 0010h -force
iSM31001:[ pevvolunbind ]Please wait for a moment.....
iSM31000:[ pevvolunbind ]Command has completed successfully.
  
```

\*Repeat the command above when the logical disk is bound with two or more PEs.

### 3. Delete the logical disk

#### 3.1 For a general IV

Run the `iSMcfg ldunbind` command to delete a general IV(\*).

Specify the ID of the target logical disk to the parameter `-ldn` in the `iSMcfg ldunbind` command.

(\*) Check the attributes (Snapshot Attribute, RPL Attribute, and Clone Attribute) of the logical disk according to the `iSMview` command execution result in step 1. If RPL Attribute is IV and Snapshot Attribute and Clone Attribute are ---, the logical disk is a general IV.

Example:

```
iSMcfg ldunbind -ldn 10h
iSM31001:[ ldunbind ]Please wait for a moment.....
iSM31000:[ ldunbind ]Command has completed successfully.
```

#### 3.2 For FCV

Run the `iSMcfg ldunbind` command to delete FCV.

Specify the ID of the target logical disk to the parameter `-ldn` in the `iSMcfg ldunbind` command.

Example:

```
iSMcfg ldunbind -ldn 10h -fcvforce
iSM31001:[ ldunbind ]Please wait for a moment.....
iSM31000:[ ldunbind ]Command has completed successfully.
```

#### 3.3 For RV

##### 3.3.1 Check the pair relation

Run the `iSMrc_query` command to check the information of the MV paired with the RV.

Specify the logical disk name of the target RV to the parameter `-rv` in the `iSMrc_query` command.

Example:

```
iSMrc_query -rv rv_test -rvflg ld

MV: Special File      -
   LD Name            mv_test ← MV name
   Type               -
RV: Special File      -
   LD Name            rv_test
   Type               -
Activity State        separate
Sync State            separated
Copy Control State    -
Separate Start Time   2015/10/09 07:12:55
Separate End Time     2015/10/09 07:12:55
Separate Diff         0KB
Copy Diff             0KB
```

RV Access	rw
Previous Active	sep/exec

### 3.3.2 Forcibly separate the paired volumes

Run the `iSMrc_separate` command to separate the paired volumes forcibly.

Specify the logical disk name of the target MV to the parameter `-mv` and the logical disk name of the target RV to the parameter `-rv` in the `iSMrc_separate` command.

Example:

```
iSMrc_separate -mv mv_test -mvflg ld -rv rv_test -rvflg ld -force all

Separate Start          2015/10/12 04:40:31
  MV:-                  mv_test          -
  RV:-                  rv_test          -
```

### 3.3.3 Clear the pair relation

Run the `iSMrc_pair` command to clear the pair relation.

Specify the logical disk name of the target MV to the parameter `-mv` and the logical disk name of the target RV to the parameter `-rv` in the `iSMrc_pair` command.

Example:

```
iSMrc_pair -mv mv_test -mvflg ld -rv rv_test -rvflg ld -unpair
iSMrc_pair: Info:      iSM13247: Command has completed successfully.
(code=2409-0d03-0004-0000)
```

### 3.3.4 Delete RV

Run the `iSMcfg ldunbind` command to delete the logical disk.

Specify the ID of the target logical disk to the parameter `-ldn` in the `iSMcfg ldunbind` command.

Example:

```
iSMcfg ldunbind -ldn 0002h
iSM31001:[ ldunbind ]Please wait for a moment.....
iSM31000:[ ldunbind ]Command has completed successfully.
```



### 3.4 For MV

#### 3.4.1 Check the pair relation

Run the `iSMrc_query` command to check the list of RVs paired with the MV.

Specify the logical disk name of the target MV to the parameter `-mv` in the `iSMrc_query` command.

Example:

```
iSMrc_query -mv mv_test -mvflg ld

MV: Special File      -
   LD Name             mv_test
   Type                -
RV: Special File      -
   LD Name             rv_test ← RV name
   Type                -
Activity State        separate
Sync State            separated
Copy Control State    -
Separate Start Time   2015/10/09 07:12:55
Separate End Time     2015/10/09 07:12:55
Separate Diff         0KB
Copy Diff             0KB
RV Access             rw
Previous Active       sep/exec
```

#### 3.4.2 Forcibly separate the paired volumes

Run the `iSMrc_separate` command to separate the paired volumes forcibly.

See 3.2.2 for details.

#### 3.4.3 Clear the pair relation

Run the `iSMrc_pair` command to clear the pair relation.

See 3.2.3 for details.

\*Repeat the procedures in 3.3.2 and 3.3.3 when the MV is paired with two or more RVs.

#### 3.4.4 Delete MV

Run the `iSMcfg ldunbind` command to delete the logical disk.

See 3.2.4 for details.

### 3.5 For ESV

#### 3.5.1 Check the information related to ESV

Run the `iSMsc_query` command to check the EBV information and ESV status.

Specify the logical disk name of the target SV to the parameter `-sv` in the `iSMsc_query` command.

Example:

```
iSMsc_query -sv 58C232D70B53012D_SV0A7B -svflg ld

BV Information
LD Name      :      200058C232D70B53012D ← EBV name
Type         :      -
Special File :      -
State        :      normal
Reserve Area :      verified

SV Information
-:58C232D70B53012D_SV0A7B ( -6) snap/active [2015/10/10 03:20:40]
unlink ← ESV status
```

#### 3.5.2 Change the ESV access mode

When the ESV status shows active (`snap/active`), run the `iSMsc_chgmod` command to change the access mode of ESV.

Specify the logical disk name of the target volume to the parameter `-vol` in the `iSMsc_chgmod` command.

Example:

```
iSMsc_chgmod -vol 58C232D70B53012D_SV0A7B -volflg ld -volacc nr
iSMsc_chgmod:Info: iSM20010: iSMsc_chgmod has normally terminated.
```

#### 3.5.3 Delete snapshot

When the ESV status shows active (`snap/active`), run the `iSMsc_delete` command to delete the snapshot.

Specify the logical disk name of the target BV to the parameter `-bv` and the logical disk name of the target SV to the parameter `-sv` in the `iSMsc_delete` command.

Example:

```
iSMsc_delete -bv 200058C232D70B53012D -bvflg ld -sv
58C232D70B53012D_SV0A7B -svflg ld
iSMsc_delete:Info: iSM19126: Specified SV has been deleted.
SV:58C232D70B53012D_SV0A7B
```

### 3.5.4 Clear the ESV generation

Run the `iSMcfg generationdel` command to clear the snapshot generation.

Specify the parameters `-bvname` and `-svname` with the “Logical disk type:Logical disk name” format in the `iSMcfg generationdel` command.

When no logical disk type is set, specify the parameters with the “:Logical disk name” format.

Example:

```
iSMcfg generationdel -bvname :200058C232D70B53012D
-svname :58C232D70B53012D_SV0A7B
iSM31001:[ generationdel ]Please wait for a moment.....
iSM31000:[ generationdel ]Command has completed successfully.
```

## 3.6 For EBV

### 3.6.1 Check the EBV information

Run the `iSMsc_query` command to get the list of ESVs under the EBV.

Example:

```
iSMsc_query -bv 200000255CDB05310269 -bvflg ld -summary

BV Information
  LD Name      : 200000255CDB05310269
  Type        : -
  Special File : -
  State       : normal
  Reserve Area: verified

SV Information
  -:00255CDB05310269_SV0499 ( -1) snap/active [2015/10/12 18:44:20]
  unlink ← ESV information (ESV name, ESV status)
```

### 3.6.2 Delete all ESVs under the EBV

Delete all ESVs under the EBV following the procedure in 3.4.

### 3.6.3 Delete EBV

Run the `iSMcfg ldunbind` command to delete the EBV.

See 3.2.4 for details.

### 3.7 For FCV/EBV

#### 3.7.1 Check the EBV information

Run the `iSMsc_query` command to get the list of ESVs under the EBV.

See 3.5.1 for details.

#### 3.7.2 Delete all ESVs under the EBV

Delete all ESVs under the EBV following the procedure in 3.4.

#### 3.7.3 Delete FCV

See 3.1 for details.

### 3.8 For MV/EBV

#### 3.8.1 Check the EBV information

Run the `iSMsc_query` command to get the list of ESVs under the EBV.

See 3.5.1 for details.

#### 3.8.2 Delete all ESVs under the EBV

Delete all ESVs under the EBV following the procedure in 3.4.

#### 3.8.3 Delete MV

See 3.3 for details.

### 4. Restarting VASA Provider

Note: For details about how to restart VASA Provider, refer to “2.3 Maintenance of VASA Provider” > “Restarting VASA Provider”

## Appendix B Messages

### B.1 Messages

Following describes the messages to be output in Event Console of vSphere Web Client.

#### **After deleting a virtual machine's backup volume by manual operation, you should apply a new backup policy to fit its real generation number.**

**Explanation:** After a backup volume of the VM is manually deleted, the policy could not be applied because the number of backup volumes of the VM does not match the number of the backup generations set in the policy.

**Measures:** Apply a policy whose number of backup generations matches the number of backup volumes of the VM after a backup volume of that VM is manually deleted.

#### **Another user is configuring the disk array.**

**Explanation:** Another user is now configuring the disk array.

**Measures:** When the monitoring state of the disk array is not "Running", wait until the state turns "Running", and try executing the operation you want again. If the Configuration Setting screen on iSM Client is open, change the screen to the State Monitoring screen. If the monitoring state of the disk array is not likely to turn "Running", run the `iSMcfg setseize -mode off -force` command. When the monitoring state of the disk array is "Running" and when this error still occurs though no other user is configuring now, the configuring state of the disk array may be retained in the disk array by mistake. In this case, run the `iSMcfg setseize -mode off -force` command.

#### **Backup can not be done for linked clones.**

**Explanation:** Since a virtual machine that was created as a linked clone does not support a backup policy, a backup volume was not created.

**Measures:** None.

#### **Command failed.**

**Explanation:** The command execution failed because the monitoring state of the disk array is "Running".

**Measures:** Check the monitoring state of the disk array, restart monitoring the disk array, and execute the command again.

### **Failed to add generation.**

- Explanation: A snapshot could not be created due to any of the following reasons:
- The capacity of the specified BV is incorrect.
  - There is no SRA in the specified pool.
  - The capacity of the specified pool is insufficient.
  - The specified pool has an LD whose capacity rate is being changed.
- Measures: Refer to “Measures” of message iSM31525 in the “Messages Handbook.”

### **Failed to apply the storage policy because I/O control mode is disabled in the pool. Enable I/O control mode.**

- Explanation: The operation failed because the I/O upper or lower control mode is disabled for the pool in which to create a virtual machine.
- Measures: Enable the I/O upper or lower control mode for the pool, rescan the storage provider, and execute the failed operation again.

### **Failed to apply the storage policy because no pool for backup exists.**

- Explanation: A virtual machine could not be created because there is no backup pool.
- Measures: Create a backup pool whose name begins with “vvolbackup”. “vvolbackup” must be lower-case. After creating a backup volume, rescan the storage provider and then create a virtual machine again.

### **Failed to apply the storage policy because the I/O Lower Limit is larger than the I/O Upper Limit.**

- Explanation: The operation failed because an I/O upper limit that is smaller than the I/O lower limit is specified in the virtual machine storage policy.
- Measures: Edit the virtual machine storage policy so that the I/O upper limit is larger than the I/O lower limit, and then execute the failed operation again.

### **Failed to apply the storage policy because the license for I/O Load Manager is locked.**

- Explanation: The operation failed because the I/O Load Manager license is still locked.
- Measures: Check the license status and unlock the license.

### **Failed to apply the storage policy due to I/O control configuration error.**

- Explanation: Configuring the I/O Control setting failed due to the following:
- A system volume has not been created.
  - An error occurred in communication processing
- Measures: If a system volume has not been created, create it.  
If a system volume has been created, configure the I/O Control setting again.

**Failed to bind a linked clone.**

- Explanation: A fast clone could not be created due to any of the following reasons:
- The specified pool is in the rotation stop state.
  - The capacity of the specified FEV is incorrect.
  - The capacity of the specified pool is insufficient.
  - The specified pool has the LD whose capacity rate is being changed.
- Measures: Refer to “Measures” of message iSM31527 in the “Messages Handbook.”

**Failed to bind PE and VVOL.**

- Explanation: The SCSI command to bind a PE and VVOL failed because the monitoring state of the disk array is not “Running”.
- Measures: Check the monitoring state of the disk array, restart monitoring the disk array, and run the command again.

**Failed to create linkclone because linkclone can't be created into auto deploy.**

- Explanation: Since the fast clone creation does not support the auto deploy function, creating a fast clone failed.
- Measures: When using the fast clone function, use a datastore that is supported by the fast clone.

**Failed to create snapshot because there is no SRA in pool(<aaa...a>).**

- Explanation: Since no SRA has been created, creating a snapshot failed.  
aaa...a: Pool number
- Measures: Create an SRA and then create a snapshot again.

**Failed to create the file that shows the relation between storage and virtual machines because login to vCenter Server failed.**

- Explanation: Failed to log in to vCenter Server.
- Measures: The information (IP address, user name, password, and port number) that was registered by using the `SetProviderConf` command of VASA Provider may not be correct. Register the vCenter Server information again.

**Failed to create the file that shows the relation between storage and virtual machines.**

- Explanation: A configuration file (XML file) in which virtual machine information is associated with storage information could not be created.
- Measures: The cause of this failure may be insufficient disk capacity. Check the disk capacity and make sure there is enough free space.

### **Failed to expand the volume(But had succeed in expanding backup volume. Target capacity:<aaa...a>).**

- Explanation: The backup volume of the VM was expanded successfully, but the hard disk of the VM could not be expanded.
- aaa...a: Current capacity of the backup volume of the VM (MB)
- Measures: Expand the VM again specifying a value equal to or larger than <aaa...a> for the capacity.

### **Failed to expand the second backup volume(backup volume:<aaa...a>, capacity:<bbb...b>).**

- Explanation: The first generation backup volume of the VM has been expanded successfully. However, the second generation backup volume of the VM could not be expanded. Therefore, expanding the hard disk of the VM has been halted.
- aaa...a: Logical disk number of the volume whose capacity could not be expanded
- bbb...b: Value specified for the capacity after expansion (MB)
- Measures: Expand the VM again specifying a value equal to or larger than <bbb...b> for the capacity.

### **Failed to expand the specified volume because the volume is being replicated.**

- Explanation: The target logical disk could not be expanded because it is now being backed up (replicated).
- Measures: A logical disk in the replicate state cannot be expanded. Check that the target logical disk is in the separate state and expand its capacity again.

### **Failed to get information from the disk array.**

- Explanation: The telegram could not be acquired from the disk array because the monitoring state of the disk array is not "Running".
- Measures: Check the monitoring state of the disk array, restart monitoring the disk array, and run the command again.

### **Failed to get the information (bitmap) on the specified VVOLs.**

- Explanation: Difference information of the data in the specified VVOL could not be acquired because the monitoring state of the disk array is not "Running".
- Measures: Check the monitoring state of the disk array, restart monitoring the disk array, and run the command again.



**Failed to unbind PE and VVOL.**

- Explanation: The SCSI command to unbind a PE and VVOL failed because the monitoring state of the disk array is not “Running”.
- Measures: Check the monitoring state of the disk array, restart monitoring the disk array, and run the command again.

**Failed to write metadata to the VVOL.**

- Explanation: The SCSI command to write management information into the created VVOL failed because the monitoring state of the disk array is not “Running”.
- Measures: Check the monitoring state of the disk array, restart monitoring the disk array, and run the command again.

**Failed to expand the backup volume because the target capacity(<aaa...a>) is less than the present one(<bbb...b>).**

- Explanation: The virtual machine backup volume could not be expanded.
- aaa...a: Specified capacity (MB)
- bbb...b: Current backup volume capacity (MB)
- Measures: Expand the virtual machine capacity again by specifying the capacity equal to or larger than <bbb...b>.

**Insufficient pool space.**

- Explanation: The specified pool does not have enough free space.
- Measures: Check the datastore capacity.

**Specified operation cannot be executed on logical disk.**

- Explanation: Since logical disks are locked by the configuration setting operation guard, the command cannot be executed.
- Measures: Refer to “Measures” of message iSM31529 in the “Messages Handbook.”

**No SSV is created.**

- Explanation: A solution reserved volume has not been created.
- Measures: Create a solution reserved volume, and execute the operation again.

**The disk array has only one pool for backup.**

- Explanation: Since the disk array has only one available backup pool, two generations of backups were created in the same backup pool.
- Measures: None

**The capacity allocated to the pool(<aaa...a>) on the disk array(<bbb...b>) has exceeded the actual capacity threshold of the pool.**

- Explanation: The actual used capacity for the pool of the disk array exceeded the actual capacity threshold.
- aaa...a: Specified pool number.
- bbb...b: Specified disk array serial number.
- Measures: Perform maintenance according to the troubleshooting procedures in “Events When Monitoring Capacity” in the “Thin Provisioning User's Manual”.

**The disk array is not in normal monitoring state.**

- Explanation: The operation failed because the monitoring state of the disk array is not “Running”.
- Measures: Check the monitoring state of the disk array, restart monitoring the disk array, and run the command again.

**The license for DynamicDataReplication is locked.**

- Explanation: The operation failed because the DynamicDataReplication license is locked.
- Measures: Check the license status, and unlock the license.

**The license for snapshot is locked.**

- Explanation: The operation failed because the snapshot license is locked.
- Measures: Check the license status, and unlock the license.

**The license for Virtual Volume is locked.**

- Explanation: The operation failed because the Virtual Volume license is locked.
- Measures: Check the license status, and unlock the license.

**The license for Volume Clone is locked.**

- Explanation: The operation failed because the Volume Clone license is locked.
- Measures: Check the license status, and unlock the license.

**The number of LDs has reached the upper limit in the specified pool.**

- Explanation: The number of logical disks created in the pool has reached the upper limit.
- Measures: Delete unnecessary logical disks, and execute the operation again.

**The number of LDs has reached the upper limit of the disk array.**

- Explanation: The number of logical disks has reached the upper limit.
- Measures: Delete unnecessary logical disks, and execute the operation again.

**The number of LDs paired to the LD has reached the upper limit.**

Explanation: A logical disk for backing up the virtual machine could not be created because the number of replication pairs has reached the maximum number specified by the specifications.

Measures: Delete unnecessary replication pairs and create a logical disk again.

**The number of volume layers has reached the upper limit.**

Explanation: The number of logical disks that are serially linked between a volume clone and snapshot or between volume clones has reached the upper limit.

Measures: Delete unnecessary snapshots or fast clone volumes and execute the operation again.

**The process cannot run on the virtual machine because the disk array is deleting snapshots.**

Explanation: The operation which is related to the virtual machine cannot be executed because the snapshot is being deleted in the disk array.

Measures: After deleting snapshot has completed in disk array, execute the operation again.

**The specified <aaa...a> does not exist.**

Explanation: The operation failed because vCenter Server requested to delete a non-existent VVOL.  
aaa...a: Target VVOL

Measures: Check whether the deletion of the VVOL managed by vCenter Server affects the disk array system.

Be sure to not delete the VVOL managed by vCenter Server by using other than vCenter Server.

**The specified datastore does not satisfy the rule(<aaa...a>) in the storage policy for the virtual machines. The value of the datastore's capability is "<bbb...b>" while the value in the storage policy for the virtual machines is "<ccc...c>."**

Explanation: The operation failed because the specified datastore does not satisfy the rule of the virtual machine storage policy.

aaa...a: Rule name based on the data service

bbb...b: capability Profile value of the datastore

ccc...c: Value of the rule of the virtual machine storage policy

Explanation: Specify the datastore that satisfies the rule of the virtual machine storage policy and execute the operation again.

**The specified LD is locked.**

Explanation: The command could not be run because the specified logical disk is locked by the configuration setting operation guard.

Measures: Unlock the logical disk, and run the command again.

### **The specified LD does not exist.**

- Explanation: The operation failed because vCenter Server requested to delete a non-existent VVOL.
- Measures: Check whether the deletion of the VVOL managed by vCenter Server affects the disk array system.
- Be sure to not delete the VVOL managed by vCenter Server by using other than vCenter Server.

### **The specified pool does not support this function (DynamicSnapVolume).**

- Explanation: The snapshot operation cannot be executed because the specified pool is not a virtual capacity pool.
- Measures: Specify a virtual capacity pool.

### **The specified pool does not support this function (Volume Clone).**

- Explanation: The Fast Clone operation cannot be executed because the specified pool is not a virtual capacity pool.
- Measures: Specify a virtual capacity pool.

### **The state of disk array monitoring is stop (maintenance). Check the status of monitoring, and then try again.**

- Explanation: The operation failed because the monitoring state of the disk array is not “Stopped (Maintenance)”.
- Measures: Check the monitoring state of the disk array, restart monitoring the disk array, and run the command again.

### **The state of pool is not normal.**

- Explanation: The status of the specified pool is invalid.
- Measures: Refer to “Measures” of message iSM31377 in the “Messages Handbook.”

### **The used capacity of SRA in pool(<aaa...a>) is over the prediction of capacity threshold.**

- Explanation: The SRA usage exceeded the threshold (pre).
- aaa...a: Pool number
- Measures: None.

### **The used capacity of SRA in pool(<aaa...a>) is over capacity threshold.**

- Explanation: The SRA usage exceeded the threshold.
- aaa...a: Pool number
- Measures: None.

**The volume capacity over 10TB is not supported.**

Explanation: The operation cannot be executed because the logical disk capacity is specified more than 10TB.

Measures: The logical disk capacity cannot be specified more than 10 TB, specify less than 10TB for the logical disk capacity and execute the operation again.

**The volume size you have specified (<aaa...a>MB) is less than 1 GB. But the volume (<bbb...b>) is created with 1 GB in the disk array because a volume requires at least 1 GB.**

Explanation: The minimum capacity of a logical disk that can be created in the disk array is 1 GB. Therefore, a 1 GB logical disk was created

aaa...a: Capacity of the logical disk (MB)

bbb...b: UUID of the logical disk

Measures: None.

**You cannot create any more FCV because the number of FCVs of the specified FEV has reached the upper limit.**

Explanation: No more fast clone volumes can be created because 256 fast clone volumes have already been created for the specified FEV.

Measures: Delete unnecessary fast clone volumes and execute the operation again.

**You cannot create any more snapshot because the number of snapshots is limited to 256 per virtual machine.**

Explanation: No more snapshots can be created because 256 snapshots have already been created for one virtual machine.

Measures: Delete unnecessary snapshots and execute the operation again. Note that a temporary snapshot may be created when a virtual machine is restored from a snapshot.

**You cannot delete a virtual machine's backup volume only by applying a new backup policy.**

Explanation: The created backup volumes cannot be deleted by applying a different backup policy.

Measures: To decrease the number of backup generations, delete unnecessary backup volume and apply a policy whose number of backup generations matches the number of backup volumes of the target VM.

**Storage provider [<aaa...a>] raised an alert type 'Object' on VM:<bbb...b>-<ccc...c>:  
[WebClient Plugin] Specified VM(<bbb...b>/<ccc...c>) does not exist. Check the  
specifications or check whether the connection destination of vCenter Server that  
was registered to VASA Provider is correct.**

Explanation: The specified virtual machine name or data center name does not exist.  
aaa...a: Storage provider name  
bbb...b: Data center name  
ccc...c: Virtual machine name  
Measures: Check the specifications, or check whether the connection destination of vCenter Server  
that was registered to VASA Provider is correct.

**Storage provider [<aaa...a>] raised an alert type 'Object' on VM:<bbb...b>-<ccc...c>:  
[WebClient Plugin] Failed to get information of specified VM(<bbb...b>/<ccc...c>)  
from VM-VVOL relation file. Please collect the fault information.**

Explanation: The virtual machine information could not be obtained.  
aaa...a: Storage provider name  
bbb...b: Data center name  
ccc...c: Virtual machine name  
Measures: Collect the fault information and contact your service representative.

**Storage provider [<aaa...a>] raised an alert type 'Object' on VM:<bbb...b>-<ccc...c>:  
[WebClient Plugin] The backup policy of VM(<bbb...b>/<ccc...c>) is not set. Set a  
backup policy to the virtual machine to acquire the newest configuration  
information, and then retry backup.If it failed, check the specified options. To check  
whether the newest configuration information was applied, check the backup  
volume configuration by using the VM-VVOLRelation.bat command.**

Explanation: The non-disruptive backup could not be performed because a backup volume (RV) does  
not exist in the specified virtual machine.  
aaa...a: Storage provider name  
bbb...b: Data center name  
ccc...c: Virtual machine name  
Measures: Set a backup policy to the virtual machine to automatically acquire the newest  
configuration information, and then retry backup.  
If the command failed, check the specified options.  
To check whether the newest configuration information was applied, check the backup  
volume configuration by using the VM-VVOLRelation.bat command.

---

**Storage provider [<aaa...a>] raised an alert type 'Object' on VM:<bbb...b>-<ccc...c>: [WebClient Plugin] Failed to backup for VM(<bbb...b>/<ccc...c>).Backup is already running. Please retry after the backing up is finished.**

Explanation: Since the specified virtual machine is being backed up, a non-disruptive backup cannot be performed.

aaa...a: Storage provider name

bbb...b: Data center name

ccc...c: Virtual machine name

Measures: Wait until backing up the virtual machine is complete, and retry the operation.

**Storage provider [<aaa...a>] raised an alert type 'Object' on VM:<bbb...b>-<ccc...c>: [WebClient Plugin] Failed to get information of specified VM(<bbb...b>/<ccc...c>).Please check the disk array status and that monitoring state of iSM.If the cause of the error could not be identified, collect the fault information.**

Explanation: Failed to get the information of the specified virtual machine.

aaa...a: Storage provider name

bbb...b: Data center name

ccc...c: Virtual machine name

Measures: Check the status of the monitored disk array and the monitoring status from the iSM server. If the cause of the error could not be identified, collect the fault information and contact your service representative.

**Storage provider [<aaa...a>] raised an alert type 'Object' on VM:<bbb...b>-<ccc...c>: [WebClient Plugin] Failed to execute command(<ddd...d>.<eee...e>). Please check the output message by "NEC Storage Software Messages Handbook", and then take the necessary action.**

Explanation: Failed to execute an iSM command.

aaa...a: Storage provider name

bbb...b: Data center name

ccc...c: Virtual machine name

ddd...d: Command name

eee...e: Message output when the command failed

Measures: Check the output message by referring to "Messages Handbook", and then take the necessary action.

**Storage provider [<aaa...a>] raised an alert type 'Object' on VM:<bbb...b>-<ccc...c>:  
[WebClient Plugin] Failed to backup for VM(<bbb...b>/<ccc...c>).Restoring is still  
running. Please retry after the backing up is restored.**

Explanation: Since the specified virtual machine is being backed up, a non-disruptive backup cannot be performed.  
aaa...a: Storage provider name  
bbb...b: Data center name  
ccc...c: Virtual machine name  
Measures: Wait until backing up the virtual machine is complete, and retry the operation.

**Storage provider [<aaa...a>] raised an alert type 'Object' on VM:<bbb...b>-<ccc...c>:  
[WebClient Plugin] Failed to get information of vCenter server from VASA  
configuration file. Please check whether the connection destination of vCenter  
Server that was registered to VASA Provider is correct.**

Explanation: Failed to get information of vCenter server.  
aaa...a: Storage provider name  
bbb...b: Data center name  
ccc...c: Virtual machine name  
Measures: Check that the connection information of the vCenter server registered to VASA Provider is correct.

**Storage provider [<aaa...a>] raised an alert type 'Object' on VM:<bbb...b>-<ccc...c>:  
[WebClient Plugin] Failed to communicate with VASA Provider. Please collect the  
fault information.**

Explanation: Failed to communicate with VASA Provider.  
aaa...a: Storage provider name  
bbb...b: Data center name  
ccc...c: Virtual machine name  
Measures: Collect the fault information and contact your service representative.

**Storage provider [<aaa...a>] raised an alert type 'Object' on VM:<bbb...b>-<ccc...c>:  
[WebClient Plugin] Number of snapshot reached the upper limit. Please delete  
unnecessary snapshots.**

Explanation: The number of created snapshots has reached the upper limit.  
aaa...a: Storage provider name  
bbb...b: Data center name  
ccc...c: Virtual machine name  
Measures: Delete unnecessary snapshots.



---

**Storage provider [<aaa...a>] raised an alert type 'Object' on VM:<bbb...b>-<ccc...c>:  
[WebClient Plugin] Unexpected error occurred. Please collect the fault information.**

Explanation: Failed to get the virtual machine information because an unexpected error occurred.

aaa...a: Storage provider name

bbb...b: Data center name

ccc...c: Virtual machine name

Measures: Collect the fault information and contact your service representative.

**Storage provider [<aaa...a>] raised an alert type 'Object' on VM:<bbb...b>-<ccc...c>:  
[WebClient Plugin] Failed to create snapshot(<ddd...d>) of specified  
VM(<bbb...b>/<ccc...c>). Please collect the fault information.**

Explanation: Failed to create a snapshot.

aaa...a: Storage provider name

bbb...b: Data center name

ccc...c: Virtual machine name

ddd...d: Snapshot name

Measures: Collect the fault information and contact your service representative.

**Storage provider [<aaa...a>] raised an alert type 'Object' on VM:<bbb...b>-<ccc...c>:  
[WebClient Plugin] Failed to delete snapshot(<ddd...d>) when backing up  
VM(<bbb...b>/<ccc...c>). Please manually delete the snapshot by vSphere Web  
Client and collect the fault information.**

Explanation: Failed to delete the snapshot.

aaa...a: Storage provider name

bbb...b: Data center name

ccc...c: Virtual machine name

ddd...d: Snapshot name

Measures: Delete the snapshot from vSphere Web Client.

Collect the fault information and contact your service representative.

**Storage provider [<aaa...a>] raised an alert type 'Object' on VM:<bbb...b>-<ccc...c>:  
[WebClient Plugin] Failed to update the time of backup because of failing to execute  
command(<ddd...d>).<eee...e>.Please check the output message by "NEC Storage  
Software Messages Handbook", and then take the necessary action.**

Explanation: After the backup is complete, failed to check and update the backup time.  
aaa...a: Storage provider name  
bbb...b: Data center name  
ccc...c: Virtual machine name  
ddd...d: Name of the failed command  
eee...e: Message output when the command failed  
Measures: Check the output message by referring to "Messages Handbook", and then take the  
necessary action.

**Storage provider [<aaa...a>] raised an alert type 'Object' on VM:<bbb...b>-<ccc...c>:  
[WebClient Plugin] Failed to update the backup status. Please check the state of  
VASA Provider and collect the fault information.**

Explanation: Failed to update the backup status.  
aaa...a: Storage provider name  
bbb...b: Data center name  
ccc...c: Virtual machine name  
Measures: Check the status of VASA Provider. Collect the fault information and contact your  
service representative.

**Storage provider [<aaa...a>] raised an alert type 'Object' on VM:<bbb...b>-<ccc...c>:  
[WebClient Plugin] Failed to back up VM(<bbb...b>/<ccc...c>).Backup is interrupted.  
Please retry.**

Explanation: Backing up the virtual machine was aborted.  
aaa...a: Storage provider name  
bbb...b: Data center name  
ccc...c: Virtual machine name  
Measures: Retry the operation.

## Appendix C Files

### C.1 Configuration File

This section describes the configuration file (XML file) in which virtual machine information is associated with storage information.

You can check logical disks that are associated with a virtual machine by referring this file.

- The configuration file is output in the following folder:

```
<VASA Provider Installation Folder>\latestRelationBetweenVMandVVOL\  
XXXX_ZZZ\YYYYMMDDHHMMSS.xml
```

XXXX\_ZZZ: <WWN of Disk array>\_<Disk Array Name>

A WWN of a disk array is a 16-digit hexadecimal number.

YYYY: Year

MM: Month

DD: Day

HH: Hour

MM: Minute

SS: Second



The configuration file is used to back up a VVOL. Therefore, be sure to not delete this file.

- The configuration file is output when a configuration change is detected while checking whether the configuration is changed (for example, a VVOL is added or deleted) at 5-minute intervals.

- File generations are managed as follows:

Up to three day's generation files (old files) of the configuration file are saved in the following folder:

```
<VASA Provider Installation Folder>\RelationBetweenVMandVVOL\  
XXXX_ZZZ\YYYYMMDDHHMMSS.zip
```

XXXX\_ZZZ: <WWN of Disk array>\_<Disk Array Name>

A WWN of a disk array is a 16-digit hexadecimal number.

YYYY: Year

MM: Month

DD: Day

HH: Hour

MM: Minute

SS: Second

- The following table describes the attributes used in the configuration file.

Table D-1 Attributes in the Configuration File (XML File)

Item (Tag) Name	Description	Attribute Name	Description
<Information>	File information	startTimestamp	Start time of configuration information collection
		finishTimestamp	End time of configuration information collection
		infoType	Information type
		fileVersion	File version
		vCenterServer	vCenterServer information
		<diskArray>	Disk array information
<diskArray>	Disk array information	Ip	IP address of disk array
		serialNumber	Serial number
		name	Disk array name
		WWN	WWN of disk array
		model	Disk array model name
		<datacenter>	Data center information
		<datacenterList>	List of data center information
<datacenterList>	List of data center information	<datacenter>	Data center information
<datacenter>	Data center information	name	Data center name
		<validVVOLList>	List of valid VVOL information
		<unManageVVOLList>	List of VVOL information that is not managed by vCenter Server
<validVVOLList>	List of valid VVOL information	<VM>	Virtual machine information
<VM>	Virtual machine information	name	Virtual machine name
		id	Virtual machine UUID
		<configVVOL>	config-VVOL information of a virtual machine
		<dataList>	List of vmdk-VVOL information of a virtual machine
		<swapVVOL>	swap-VVOL information of a virtual machine
		<memoryList>	List of memory-VVOL information of a virtual machine
		<fastcloneSourceVM>	Information of source virtual machine of fast clone
		<fastcloneTargetList>	List of information of a destination virtual machine of a fast clone
<configVVOL>	config-VVOL information of a virtual machine	Id	Logical disk number
		name	VVOL name
		<rv>	Backup destination of a VVOL
<dataList>	List of vmdk-VVOL information of a virtual machine	<dataVVOL>	vmdk-VVOL information of a virtual machine

Item (Tag) Name	Description	Attribute Name	Description
<dataVVOL>	vmdk-VVOL information of a virtual machine	id	Logical disk number
		name	VVOL name
		namespace	namespace information
		<snapshot>	Snapshot information
		<rv>	Backup destination of VVOL
<snapshot>	Snapshot information	id	Logical disk number
<rv>	Backup destination of a VVOL	id	Logical disk number of backup destination of VVOL
<swapVVOL>	swap-VVOL information of a virtual machine	id	Logical disk number
		name	VVOL name
		namespace	namespace information
<memoryList>	List of memory-VVOL information of a virtual machine	<memoryVVOL>	memory-VVOL information of a virtual machine
<memoryVVOL>	memory-VVOL information of a virtual machine	id	Logical disk number
		name	VVOL name
		namespace	namespace information
<fastcloneSourceVM >	Information of a source virtual machine of a fast clone	name	Virtual machine name
<fastcloneTargetList >	Information of a target virtual machine of a fast clone	<fastcloneTargetVM >	Information of a source virtual machine of a fast clone
<fastcloneTargetVM >	Information of a target virtual machine of a fast clone	name	Virtual machine name
<unManageVVOLList>	List of VVOL information that is not managed by vCenter Server	<validVVOLList>	List of VVOL information
		<invalidVVOLList>	List of invalid VVOL information
		<actionVVOLList>	List of information of a VVOL being used
		<rvVVOLList>	List of VVOL backup destination information (virtual machine deleted)
<invalidVVOLList>	List of invalid VVOL information	<invalidVVOL>	Invalid VVOL information
<invalidVVOL>	Invalid VVOL information	id	Logical disk number
<actionVVOLList>	List of information of a VVOL being used	<deletingVVOL>	Information of a VVOL being deleted
		<cloningVVOL>	Information of a VVOL being cloned
<deletingVVOL>	Information of a VVOL being deleted	id	Logical disk number
		deletingTime	Deletion start time
<cloningVVOL>	Information of a VVOL being cloned	id	Logical disk number
		cloningTime	Cloning start time
<rvVVOLList>	List of VVOL backup destination information (virtual machine deleted)	id	Logical disk number
		type	VVOL type
		mvVMid	UUID of the source to be backed up

# Appendix D Setting up the Management Memory of the Extended Snapshot Function

This appendix describes how to specify the upper limit of the management memory by using the Storage Manager commands. The management memory is used by the snapshot function, and referred to as a *solution map* in this appendix.

The snapshot and extended snapshot functions use a solution map of the snapshot function. However, the total volume capacity that can be managed in an individual block differs between these operations. A snapshot volume can map about 16 TB, but an extended snapshot volume can map 512 TB.

The snapshot and extended snapshot functions cannot share and manage the same block. Therefore, it is necessary to prepare a block for each function. The solution map upper limit of the snapshot function is set to the total number of blocks of the snapshot and extended snapshot functions. This upper limit cannot be set individually to each function. If configuring the snapshot and extended snapshot functions on a single disk array, note the following (Figure B-1).

For the M510 and M710 disk arrays, even if the total volume capacity used by the snapshot operation exceeded the solution map upper limit, a snapshot volume can be added. However, if the total volume capacity used by the extended snapshot operation exceeded the solution map upper limit, an extended snapshot volume can be added.

Create a solution map by using the `iSMcfg setsolutionmap` command. For more information, refer to the section “iSMcfg setsolutionmap” in the “Command Reference”.

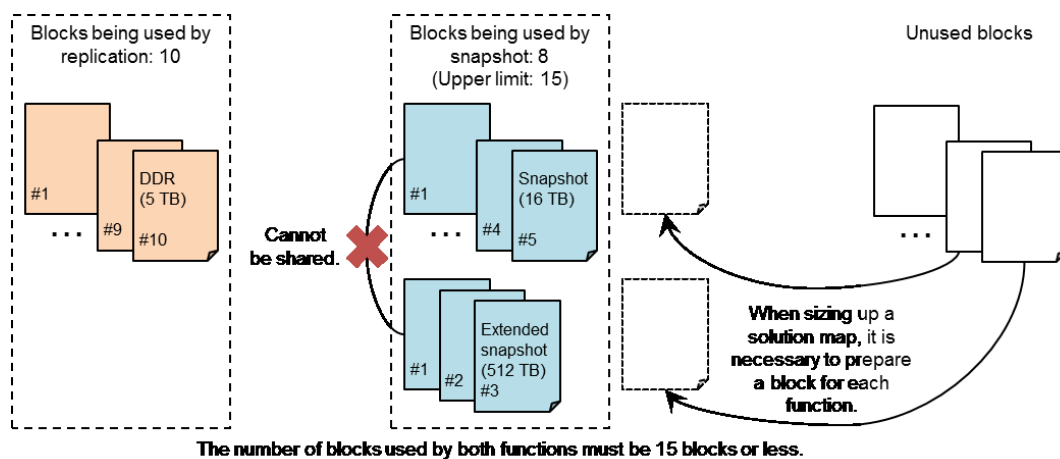

Figure C-1 Mapping and Upper Limit of the Solution Map When Concurrently Using the Snapshot and Extended Functions

### Example

The solution map of the snapshot functions (both snapshot and extended snapshot) can be expanded up to three blocks in the following conditions:

- Disk array: M710
- Cache capacity: 96 GB
- Total capacity of RVs: 360 to 365 TB
- SSD L2 Cache: Not used
- Semi-order guarantee buffer: None

#### Example 1:

The following table shows the capacity combinations of the snapshot volumes (not accessing a disk) and extended snapshot volumes when the functions are used concurrently.

Table C-1 Examples of Volume Capacity Combinations

Snapshot	Extended Snapshot
48 TB	0 TB
32 TB	512 TB
16 TB	1024 TB
0 TB	1536 TB

#### Example 2:

If the total capacity of extended snapshot volumes is 512 TB or less, the solution map of the snapshot function can be expanded up to 2 blocks (approx. 32 TB). A snapshot volume exceeding 32 TB can also be added with disk access.

#### Example 3:

If the total capacity of snapshot volumes is 32 to 48 TB, an extended snapshot volume cannot be added. To add an extended snapshot volume, the number of blocks used by the replication or snapshot function must be decreased to secure the number of blocks to be used by the extended snapshot function.

# Appendix E Backup Operations and Messages

## E.1 Backup Operations

---

This appendix describes how to use the backup operation commands for Virtual Volume.

### E.1.1 onlineBackup.bat

---

#### [ NAME ]

`onlineBackup.bat` - Starts backup for a virtual machine.

#### [ SYNOPSIS ]

`onlinebackup.bat VMName DataCenterName`

#### [ DESCRIPTION ]

The `onlineBackup.bat` command starts an online backup operation.

If an online backup operation cannot be started because the VMware Tools are not installed in the virtual machine, backup operation without keeping consistency will be started.

If there are two backup generations, an online backup operation is performed sequentially for a backup volume that has not been backed up, backup volume that could not be backed up, and then old backup volume. In this case, the backup destination is automatically determined.

#### [ OPTIONS ]

*VMName* Specify the virtual machine name of the backup target.

*DataCenterName* Specify the name of datacenter that the virtual machine is created.

#### [ DISPLAYED INFORMATION ]

```
C:\>onlineBackup.bat VMName DataCenterName

Start to check information of specified VM.
Start to backup the specified VM.
Success to online backupVM(data_center_name/vm_name).
config vvol:
  LD Name: ld_name
  Backup State: backup_state
  Backup LD Name: backup_target_ld_name
  Diskarray Name: diskarray_name of config-vvol
data vvol:
  LD Name: ld_name
  Disk File: disk_file_name
  Backup State: backup_state
  Backup LD Name: backup_target_ld_name
```



```
Diskarray Name: diskarray_name of data-vvol
```

Description of messages:

For details, see “E.2 Messages”.

#### [ NOTES ]

- This command can be executed with the Administrator group right.

#### [ RETURN VALUES ]

0: Operation terminated normally.

1: Operation terminated abnormally.

## E.1.2 VM-VVOLRelation.bat

#### [ NAME ]

VM-VVOLRelation.bat - Shows a relation between a virtual machine and Virtual Volumes.

#### [ SYNOPSIS ]

```
VM-VVOLRelation.bat VMName DataCenterName
```

#### [ DESCRIPTION ]

The VM-VVOLRelation.bat command shows a relation between specified virtual machine and Virtual Volumes.

#### [ OPTIONS ]

*VMName* Specify the virtual machine name of the backup target.

*DataCenterName* Specify the name of datacenter that the virtual machine is created.

#### [ DISPLAYED INFORMATION ]

```
C:\>VM-VVOLRelation.bat VMName DataCenterName

[VM]
--- VM Detail Information ---
VM Name           : vm_name
VM Id             : vm_id
DataCenter Name   : data_center_name
vCenterServer     : vcenter_server_ip_address

[DiskArray]
--- Disk Array Detail Information ---
Disk Array Name   : disk_array_name
Disk Array IP Address: disk_array_ip_address
Serial Number     : serial_number
```

```
World Wide Name      :      world_wide_name
Product ID           :      product_id

--- VVOL Detail Information ---
LDN(h)               :      ld_number
VMware Type          :      vmware_type

--- RV List Information ---
LDN(h)
ld_number_list

--- VVOL Detail Information ---
LDN(h)               :      ld_number
VMware Type          :      vmware_type
Disk File            :      disk_file_name

--- RV List Information ---
LDN(h)
ld_number_list
```

### Description of messages:

- VM Detail Information

*vm\_name*

Virtual machine name

*vm\_id*

Virtual machine ID

*data\_center\_name*

Data center name

*vcenter\_server\_ip\_address*

IP address of the vCenter server

- Disk Array Detail Information

*disk\_array\_name*

Disk array name

*disk\_array\_ip\_address*

IP address of the disk array

*serial\_number*

Serial number

*world\_wide\_name*

Worldwide name

*product\_id*

Product ID

- VVOL Detail Information

*ld\_number*

Logical disk number

*vmware\_type*

VMware type of the Logical disk

- config-vvol : configuration file of virtual machine

- vmdk-vvol : hard disk of virtual machine

*disk\_file\_name*

Logical disk number

\* This item is output only when VMware Type is "vmdk-vvol".

- RV List Information

*ld\_number\_list*

List of logical disk number of RV

### [ NOTES ]

- This command can be executed with the Administrator group right.

### [ RETURN VALUES ]

- 0: Operation terminated normally.
- 1: Operation terminated abnormally.

## E.2 Messages

---

The following describes the messages which may be output when backup operations are run in virtual volume environment. These messages are output in console and Windows event logs.

### **Specified VM(<aaa...a>/<bbb...b>) does not exist.**

Type: ERROR

Explanation: The specified virtual machine does not exist.

aaa...a: Data center name

bbb...b: Virtual machine name

Measures: Check the specifications, or check whether the connection destination of vCenter Server that was registered to VASA Provider is correct.

### **The backup policy of VM(<aaa...a>/<bbb...b>) is not set.**

Type: ERROR

Explanation: The backup operation could not be executed because RV does not exist in the specified virtual machine.

aaa...a: Data center name

bbb...b: Virtual machine name

Measures: Set a backup policy to the virtual machine to acquire the newest configuration information, and then retry backup.

If the command failed, check the specified options.

To check whether the newest configuration information was applied, check the backup volume configuration by using the `VM-VVOLRelation.bat` command.

### **Unexpected error occurred.**

Type: ERROR

Explanation: Failed to get the virtual machine information because an unexpected error occurred.

Measures: Collect the fault information.

### **Failed to execute command(<aaa...a>).**

**<bbb...b>**

Type: ERROR

Explanation: Failed to execute an iSM command.

aaa...a: Command name

bbb...b: Message output when the command failed

Measures: Check the output message by referring to “Messages Handbook”, and then take the necessary action.

**Failed to get information of specified VM(<aaa...a>/<bbb...b>).**

Type: ERROR  
Explanation: Failed to get the information of the specified virtual machine.  
aaa...a: Data center name  
bbb...b: Virtual machine name  
Measures: Check the disk array status and that monitoring state of iSM.  
If the cause of the error could not be identified, collect the fault information.

**Failed to get information of specified VM(<aaa...a>/<bbb...b>) from VM-VVOL relation file.**

Type: ERROR  
Explanation: Failed to get information of the specified virtual machine.  
aaa...a: Data center name  
bbb...b: Virtual machine name  
Measures: Collect the fault information.

**Failed to communicate with VASA Provider.**

Type: ERROR  
Explanation: Failed to communicate with VASA Provider.  
Measures: Collect the fault information.

**Failed to get information of vCenter server from VASA configuration file.**

Type: ERROR  
Explanation: Failed to get information of vCenter server.  
Measures: Check that the connection information of the vCenter server registered to VASA Provider is correct.

**Failed to create snapshot(<aaa...a>) of specified VM(<bbb...b>/<ccc...c>).**

Type: ERROR  
Explanation: Failed to create a snapshot.  
aaa...a: Snapshot name  
bbb...b: Data center name  
ccc...c: Virtual machine name  
Measures: Collect the fault information.

### **Failed to delete snapshot(<aaa...a>) when backing up VM(<bbb...b>/<ccc...c>).**

Type: WARNING

Explanation: Failed to delete the snapshot.

aaa...a: snapshot name

bbb...b: Data center name

ccc...c: Virtual machine name

Measures: Delete the virtual machine snapshot from vSphere Web Client.  
Collect the fault information.

### **Number of snapshots reach the upper limit.**

Type: ERROR

Explanation: The number of snapshots has reached the upper limit.

Measures: Delete unnecessary snapshots.

### **Failed to get VASA Provider install path.**

Type: ERROR

Explanation: Failed to get the VASA Provider install path.

Measures: Check that VASA Provider is installed correctly.  
Collect the fault information.

### **Start to check information of specified VM.**

Type: INFO

Explanation: Start to check information of the specified virtual machine for backup.  
This message is output in only console.

Measures: None.

### **Start to back up the specified VM.**

Type: INFO

Explanation: Start to back up the specified virtual machine.  
This message is output in only console.

Measures: None.

**Success to online backup VM(<aaa...a>/<bbb...b>).**

**config-vvol:**

**LD Name: <ccc...c>**  
**Backup State: <ddd...d>**  
**Backup LD Name: <eee...e>**  
**Diskarray Name: <fff...f>**

**data-vvol:**

**LD Name: <ggg...g>**  
**Disk File: <hhh...h>**  
**Backup State: <ddd...d>**  
**Backup LD Name: <iii...i>**  
**Diskarray Name: <fff...f>**

**...**

**LD Name: <ggg...g>**  
**Disk File: <hhh...h>**  
**Backup State: <ddd...d>**  
**Backup LD Name: <iii...i>**  
**Diskarray Name: <fff...f>**

Type: INFO

Explanation: Succeeded in online backup of the specified virtual machine with keeping consistency.

aaa...a: Data center name

bbb...b: Virtual machine name

ccc...c: Logical disk name of config-vvol

ddd...d: Backup status

(backupped: The virtual disk was backed up.

no backup: The virtual disk was not backed up.)

eee...e: Name of the logical disk to which config-vvol was backed up

fff...f: Name of the disk array to which vvol belongs

ggg...g: Logical disk name of data-vvol

hhh...h: Disk file name of data-vvol

iii...i: Name of the logical disk to which data-vvol was backed up

Measures: None.

**Success to online backup VM(<aaa...a>/<bbb...b>) without keeping consistency.**

config-vvol:

LD Name: <ccc...c>  
 Backup State: <ddd...d>  
 Backup LD Name: <eee...e>  
 Diskarray Name: <fff...f>

data-vvol:

LD Name: <ggg...g>  
 Disk File: <hhh...h>  
 Backup State: <ddd...d>  
 Backup LD Name: <iii...i>  
 Diskarray Name: <fff...f>

...

LD Name: <ggg...g>  
 Disk File: <hhh...h>  
 Backup State: <ddd...d>  
 Backup LD Name: <iii...i>  
 Diskarray Name: <fff...f>

Type: INFO

Explanation: Since VMware Tools is not installed or is not working normally in the specified virtual machine, online backing up of the specified virtual machine was executed without collaborating with VMware Tools and without keeping consistency for which VMware Tools is used, and succeeded in it.

aaa...a: Data center name

bbb...b: Virtual machine name

ccc...c: Logical disk name of config-vvol

ddd...d: Backup status

(backuped: The virtual disk was backed up.

no backup: The virtual disk was not backed up.)

eee...e: Name of the logical disk to which config-vvol was backed up

fff...f: Name of the disk array to which vvol belongs

ggg...g: Logical disk name of data-vvol

hhh...h: Disk file name of data-vvol

iii...i: Name of the logical disk to which data-vvol was backed up

Measures: None.

**Failed to back up for VM(<aaa...a>/<bbb...b>). Backup is already running.**

Type: ERROR

Explanation: Since the specified virtual machine is being backed up, a non-disruptive backup cannot be performed.

aaa...a: Data center name

bbb...b: Virtual machine name

Measures: Wait until backing up the virtual machine is complete, and retry the operation.



**Failed to back up for VM(<aaa...a>/<bbb...b>).Restoring is still running.**

Type: ERROR  
Explanation: Since the specified virtual machine is being restored, a non-disruptive backup cannot be performed.  
aaa...a: Data center name  
bbb...b: Virtual machine name  
Measures: Wait until restoring the virtual machine is complete, and retry the operation.

**Failed to back up VM(<aaa...a>/<bbb...b>).Backup is interrupted.**

Type: ERROR  
Explanation: Backing up the virtual machine was aborted.  
aaa...a: Data center name  
bbb...b: Virtual machine name  
Measures: Retry the operation.

**Failed to update the time of backup because of failing to execute command(<aaa...a>).<bbb...b>**

Type: WARNING  
Explanation: After the backup is complete, failed to check and update the backup time.  
aaa...a: Name of the failed command  
bbb...b: Message output when the command failed  
Measures: Check the output message by referring to “Messages Handbook”, and then take the necessary action.

**Failed to update the backup status.**

Type: WARNING  
Explanation: Failed to update the backup status.  
Measures: Check the status of VASA Provider. Collect the fault information and contact your service representative.

## Appendix F Virtual Volume Management Screen

### F.1 Installation and Setup Procedure

---

The Virtual Volume management screen can be displayed on VMware vSphere Web Client by installing VMware vSphere Web Client Plug-in V3.1 or later. On this management screen, the Virtual Volume information of each VM can be checked and a VM can be backed up and restored.

For how to install and set up VMware vSphere Web Client Plug-in, see the “VMware vSphere Web Client Plug Installation Guide”.

The subsequent sections describe the following three screens provided by VMware vSphere Web Client Plug-in.

- Virtual Volume VM list screen
- Virtual Volume VM backup information screen
- Virtual Volume information screen

For other VMware vSphere Web Client Plug-in screens, see the “VMware vSphere Web Client Plug-in User’s Manual.”

## F.2 Virtual Volume VM List Screen

The Virtual Volume VM list screen displays a list of VMs belonging to a host.

Multiple VMs can be backed up all at once on this screen.

To display the Virtual Volume VM list screen, select a host on vSphere Web Client, select the [Manage] tab, and then select the [NEC Storage] subtab.

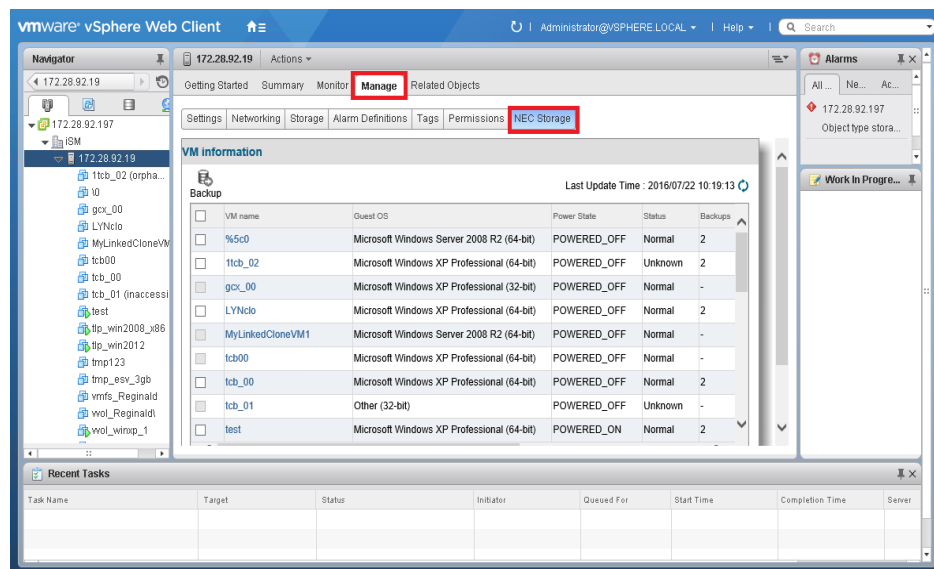

Figure F-1 Virtual Volume VM List Screen

The following information is displayed for each VM of the selected host:

### VM information

- (1) VM name
- (2) Guest OS
- (3) Power State
- (4) Status

\*For details about the status, see the vSphere manuals.

- (5) Backups

The number of backup generations of a VM is displayed. This number is the same as that set in “3.9.1 Defining a Backup Policy”.

- (6) Backup State

This column displays one of the following indicating the current status of the backup or restore operation for the VM. When backup is performed, the status usually changes in the order of “Configuration checking”, “Backing up”, and “Backup completed”.

- -

This is displayed when no backup is performed.

- Configuration checking
  - Backing up
  - Backup completed
  - Backup failed
  - Restore completed (copying in background)
  - Restore completed
  - Restore failed
- (7) Last Backup Time  
The processing time of the last backup is displayed.
- (8) Previous Backup Time  
The processing time of the backup before the last backup is displayed.

The following icon is displayed on the upper left corner of the Virtual Volume VM list screen.

- Backup icon ()  
Click this icon to back up all the selected VMs at once.

The last information update time is displayed on the upper right corner of the Virtual Volume VM list screen. Click the update icon () to update the information displayed on the screen.

To display the details of each VM, click the link of the displayed VM name. The Virtual Volume VM backup information screen will be displayed.



The screen is automatically updated but not in real time. Therefore, the displayed backup operation status (Backup State) might not match the actual backup operation status.

## F.2.1 Batch Backup

Multiple Virtual Volume VMs can be backed up all at once by using the batch backup function.



Use the batch backup function for up to four VMs. Note that using the batch backup function for more than four VMs might increase the load of the management server (for example memory usage and CPU usage are increased), decrease backup performance, and cause a backup failure of some VMs.

1. Select the VMs to be backed up and click the backup icon ( ) on the Virtual Volume VM list screen.

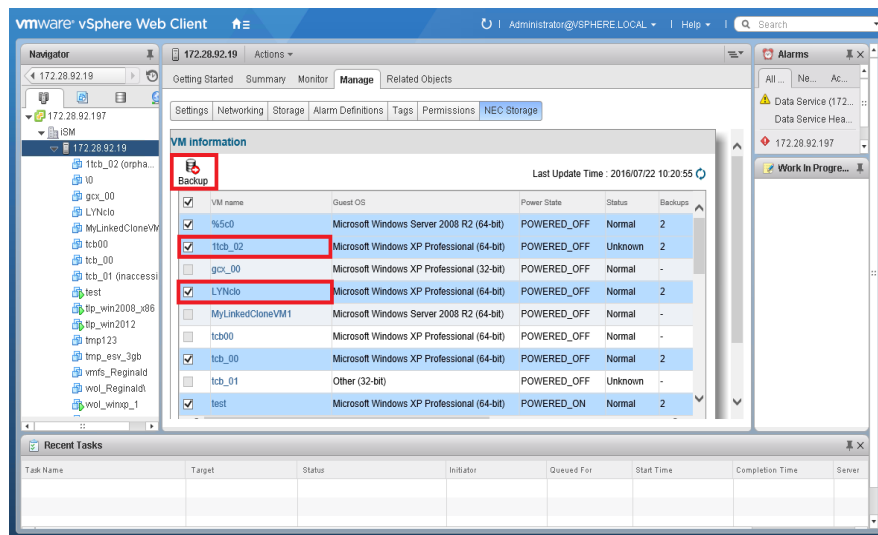

Figure F-2 Displaying the Backups Dialog Box

The Backups dialog box is displayed.

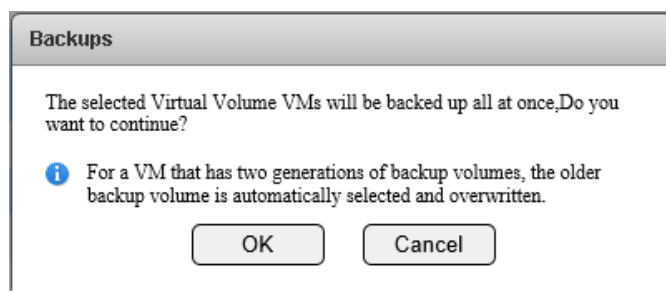

Figure F-3 Backups Dialog Box

For a VM that has two generations of backup volumes, the older backup volume is automatically selected and overwritten.

2. Click [OK] on the Backups dialog box to start the batch backup function. The following startup progress dialog box is displayed.

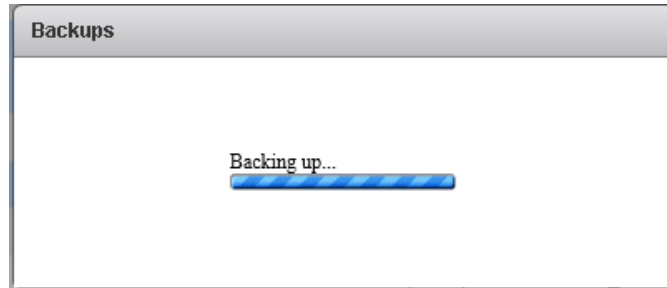

Figure F-4 Dialog Box Showing the Startup Progress

If backing up the VMs has started successfully, the following dialog box is displayed.

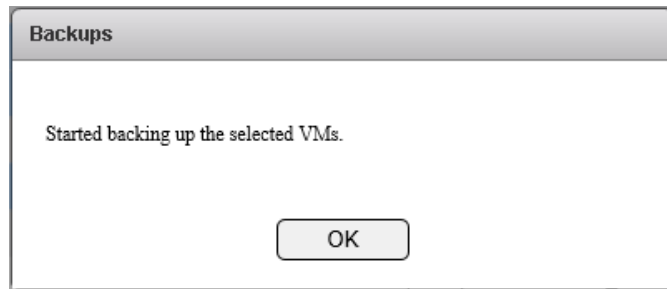

Figure F-5 Dialog Box Showing that Backup Has Started

If it failed to start backing up some of the selected VMs, the following dialog box is displayed.

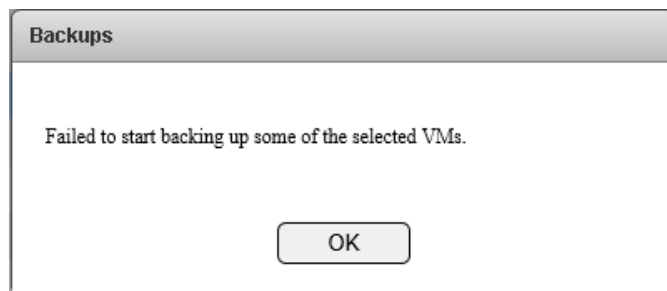

Figure F-6 Dialog Box Showing that Starting the Backup of Some VMs Failed

If it failed to start backing up the selected VMs, the following dialog box is displayed.

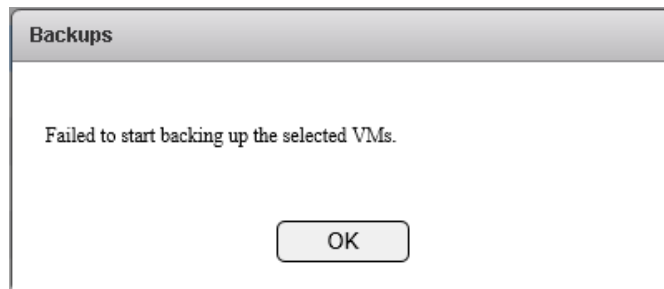

Figure F-7 Dialog Box Showing that Starting the Backup of VMs Failed



Immediately after a new VM is created or the VM configuration is changed, it takes the time specified for [Output Interval] (five minutes by default) of the VASA Provider settings at maximum until the backup function will recognize the configuration information. If the backup function is executed before the backup function recognizes the configuration changes, there is a possibility that the backup fails and the VM backup state does not change on the screen. In this case, wait until the time specified for [Output Interval] elapses and then execute the backup again.



If the VM backup state remains as “Configuration checking” after executing a backup, or if the VM backup state remains as “Backing up” and the backup remaining time(\*) does not change, the backup processing might have failed in the middle. In this case, see the event log of the management server in which VASA Provider is installed to check the backup result of the target VM.

If the backup failed or updating the backup state failed, remove the cause of failure and execute the backup again by using the `onlineBackup.bat` command of the management server.

(\*) To check the backup remaining time, click the VM name link of the target VM and check the information on the Virtual Volume VM backup information screen.

## F.3 Virtual Volume VM Backup Information Screen

The backup status of each VM and virtual disk can be checked on the Virtual Volume VM backup information screen. It is also possible to back up a VM, cancel a backup operation, create a backup script, and restore a virtual disk on this screen.

There are the following two methods to open the Virtual Volume VM backup information screen.

- Select a VM on vSphere Web Client, select the [Manage] tab, and then select the [NEC Storage] subtab.

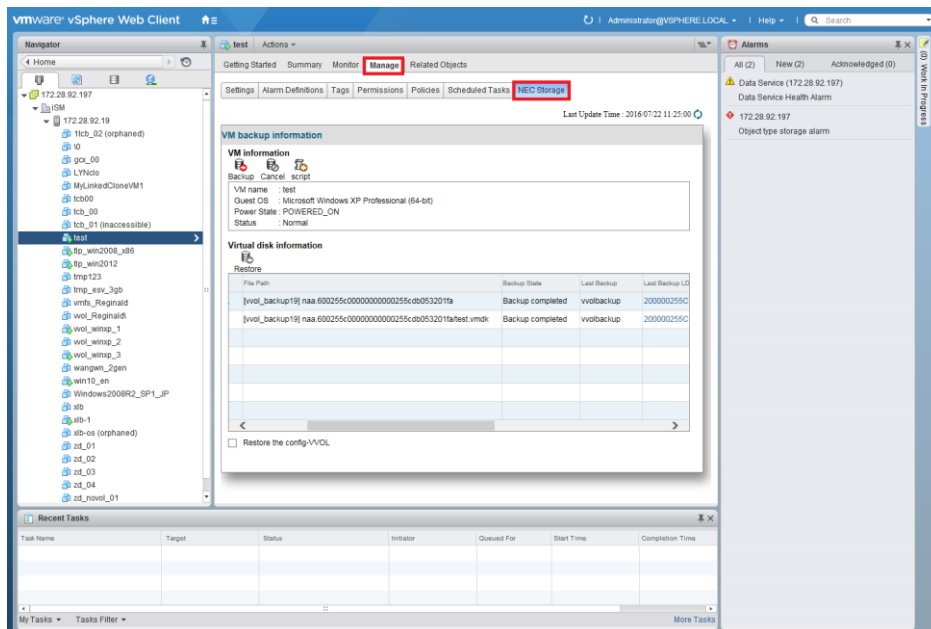

Figure F-8 Virtual Volume VM Backup Information Screen

- Click a VM name on the Virtual Volume VM list screen.



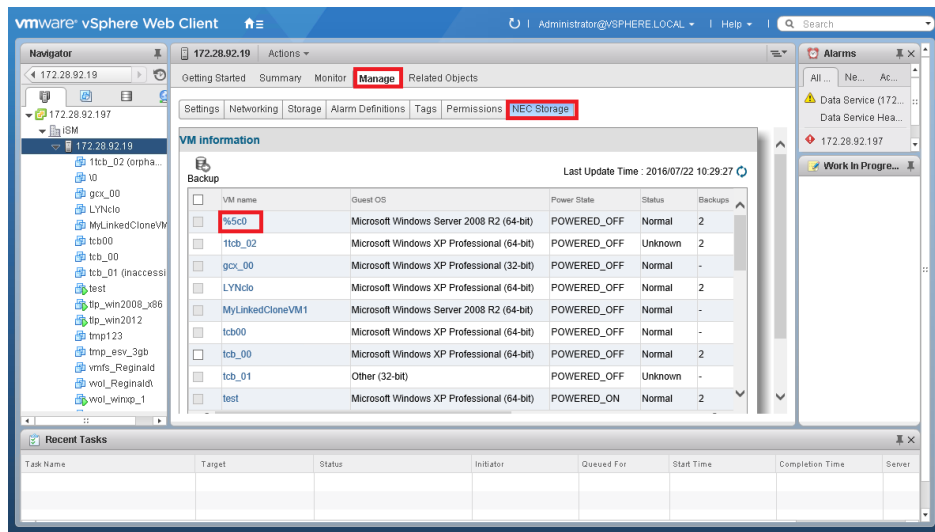

Figure F-9 Displaying the Virtual Volume VM Backup Information Screen

The following VM information is displayed for each item of Virtual Volume VM backup information:

**VM information**

- (1) VM name
- (2) Guest OS
- (3) Power State
- (4) Status

\*For details about the status, see the vSphere manuals.

**Virtual disk information**





- (5) Device Name
- (6) Type
- (7) File Path
- (8) Backup State

This column displays one of the following indicating the status of the backup/restore operation. If there are two generations, the status of each generation is displayed.

- -  
This is displayed when no backup is performed.
- Configuration checking
- Backing up  
Time remaining: xx hours yy minutes
- Backup completed
- Backup failed
- Restore completed (copying in background)  
Time remaining: xx hours yy minutes

- Restore completed
  - Restore failed
- (9) Last Backup  
The name of the pool in which the last backup volume is saved is displayed.
- (10) Last Backup LD  
The name of the logical disk that contains the last backup is displayed.
- (11) Last Backup Time  
The date of the last backup is displayed.
- (12) Previous Backup  
The name of the pool in which the backup volume before the last backup is saved is displayed.
- (13) Previous Backup LD  
The name of the logical disk that contains the backup before the last backup is displayed.
- (14) Previous Backup Time  
The time of the backup before the last backup is displayed.

The following icons are displayed on the upper left corner of the Virtual Volume VM backup information screen.

- Backup icon ()  
Click this icon to back up a VM.
- Cancel icon ()  
Click this icon to stop the current backup operation.
- Script icon ()  
Click this icon to create a backup script.
- Restore icon ()  
Click this icon to restore a backup.

The last information update time is displayed on the upper right corner of the Virtual Volume VM backup information screen.

Click the update icon () to update the information displayed on the screen.

To use the iSM Client to identify the cause of the logical disk failure, click the link of [Last Backup Destination LD Name] or [Previous Backup Destination LD Name] of the logical disk displayed on the virtual disk information screen. The iSM Client screen is displayed.



The screen is automatically updated but not in real time. Therefore, the displayed backup operation status (Backup State) might not match the actual backup operation status.

## F.3.1 Backing up a VM

A Virtual Volume VM can be backed up by using the backup function.

1. Click the backup icon (  ).

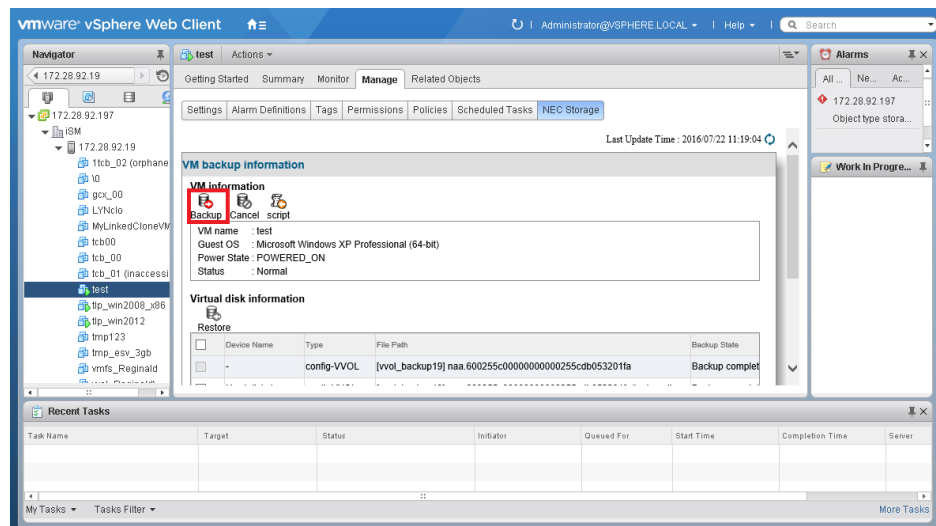

Figure F-10 Displaying the Backup Dialog Box

The Backup dialog box is displayed.

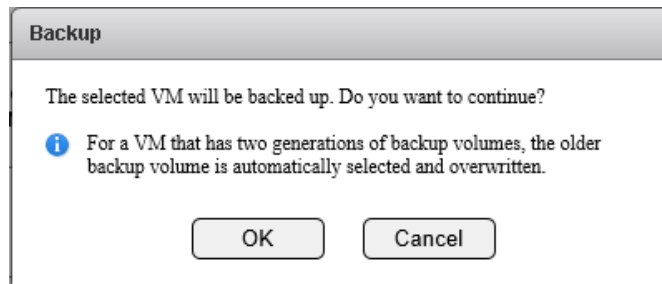

Figure F-11 Backup Dialog Box

For a VM that has two generations of backup volumes, the older backup volume is automatically selected and overwritten.

2. Click [OK] on the Backup dialog box to start the backup function. The following startup progress dialog box is displayed.

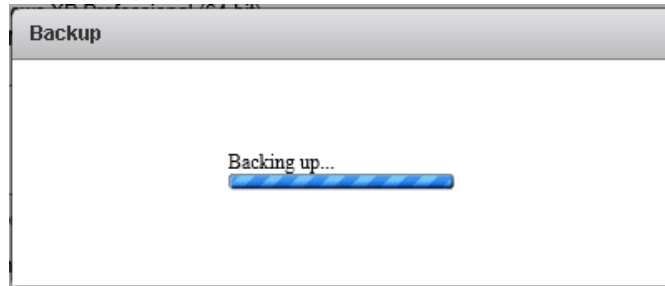

Figure F-12 Dialog Box Showing the Startup Progress

If backing up the VM has started successfully, the following dialog box is displayed.

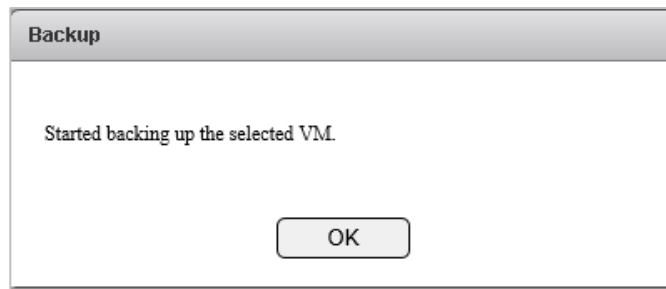

Figure F-13 Dialog Box Showing that Backup Has Started

If it failed to start backing up the VM, the following dialog box is displayed.

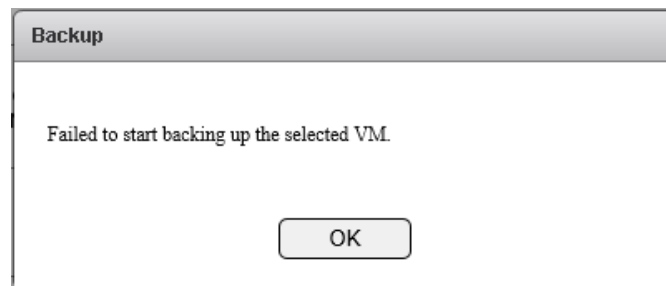

Figure F-14 Dialog Box Showing that Starting the Backup of VM Failed

For the status of the backup operation, see [Backup State] displayed on the Virtual Volume VM backup information screen.



Immediately after a new VM is created or the VM configuration is changed, it takes the time specified for [Output Interval] (five minutes by default) of the VASA Provider settings at maximum until the backup function will recognize the configuration information. If the backup function is executed before the backup function recognizes the configuration changes, there is a possibility that the backup fails and the VM backup state does not change on the screen. In this case, wait until the time specified for [Output Interval] elapses and then execute the backup again.



If the VM backup state remains as “Configuration checking” after executing a backup, or if the VM backup state remains as “Backing up” and the backup remaining time(\*) does not change, the backup processing might have failed in the middle. In this case, see the event log of the management server in which VASA Provider is installed to check the backup result of the target VM.

If the backup failed or updating the backup state failed, remove the cause of failure and execute the backup again by using the `onlineBackup.bat` command of the management server.

(\*) To check the backup remaining time, click the VM name link of the target VM and check the information on the Virtual Volume VM backup information screen.

## F.3.2 Cancelling a Backup

The running backup operation of the Virtual Volume VM can be cancelled by using the backup cancel function.

1. Click the cancel icon (🛑).

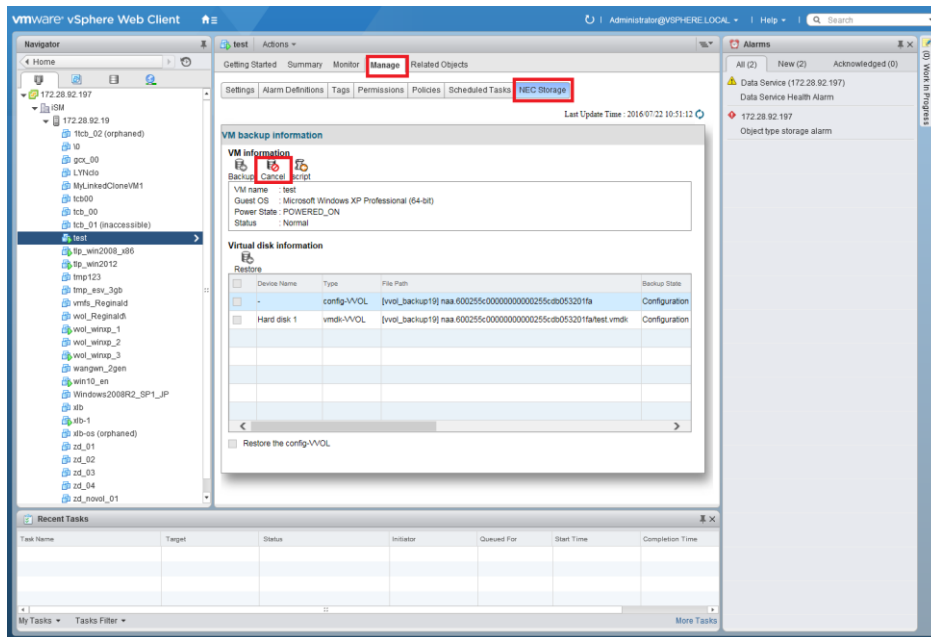

Figure F-15 Displaying the Cancel Backup Dialog Box

The Cancel backup dialog box is displayed.

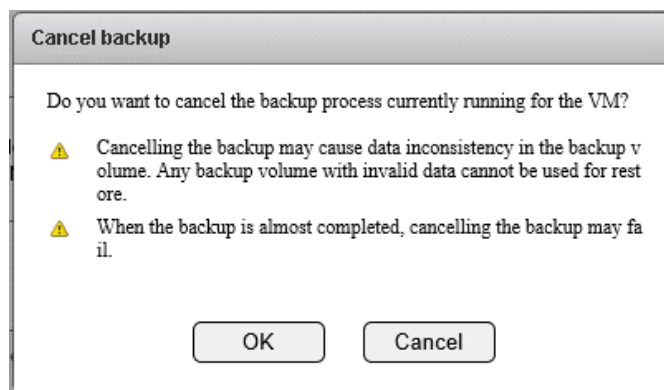

Figure F-16 Cancel Backup Dialog Box

If the backup operation is cancelled, data in the backup volume might become invalid. The backup volume including invalid data cannot be used to restore a VM. In this case, back up the VM again to make the data in the backup volume valid.

Cancellation of the mostly completed backup operation might fail. If the backup operation cannot be cancelled, wait until the operation is complete.

2. Click [OK] on the Cancel backup dialog box to start the backup cancel function. The following startup progress dialog box is displayed.

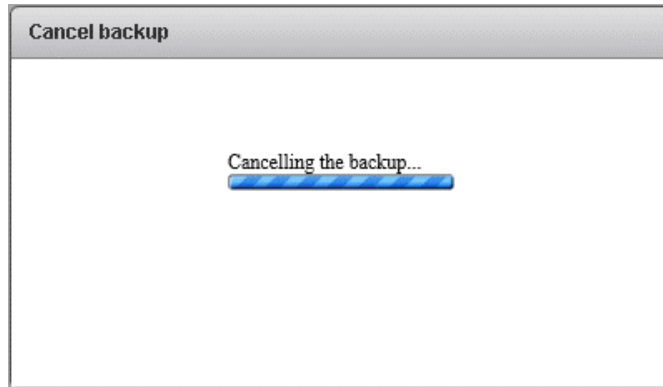

Figure F-17 Dialog Box Showing the Startup Progress

If cancelling the backup operation has started successfully, the following dialog box is displayed.

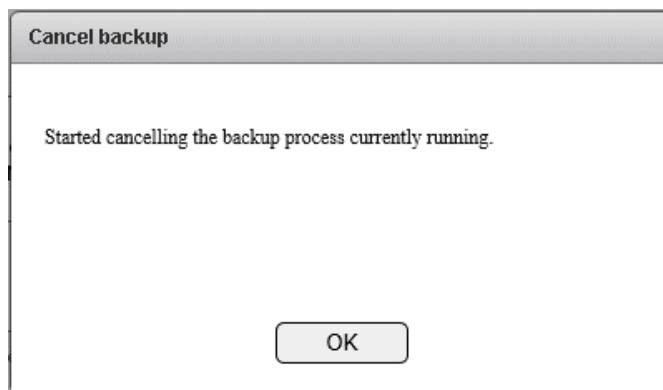

Figure F-18 Dialog Box Showing that Cancellation Has Started

If it failed to start cancelling the backup operation, the following dialog box is displayed.

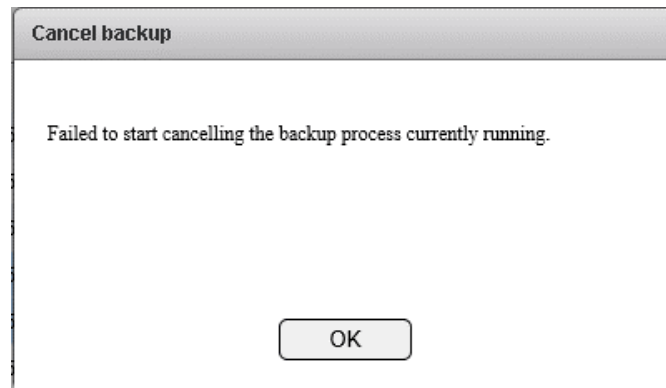

Figure F-19 Dialog Box Showing that Starting Cancellation Failed

The status of the backup volume after the backup operation was cancelled can be checked by seeing [Backup State] of [Virtual disk information] on the Virtual Volume VM backup information screen. Click the update icon (🔄) to display the latest information. If “Backup failed” is displayed for [Backup State], the data in the backup volume became invalid by cancelling the backup operation. If “Backup completed” is displayed, the data in the backup volume is valid. If “Configuration checking” or “Backing up” is displayed, the backup operation is being cancelled. In this case, wait for a while and then click the update icon again to display the latest information.



When the backup is canceled successfully, “Backup failed” is displayed for [Backup State].

In addition, the following message is output to the vSphere Web Client event.

Failed to back up VM(<aaa...a>/<bbb...b>).Backup is interrupted.

aaa...a: Data center name

bbb...b: VM name



### F.3.3 Restoring a Backup

A Virtual Volume VM can be restored in units of virtual disks to the data when it was backed up by using the restore function.

1. Select a Virtual Volume to be restored and click the restore icon (🔄).

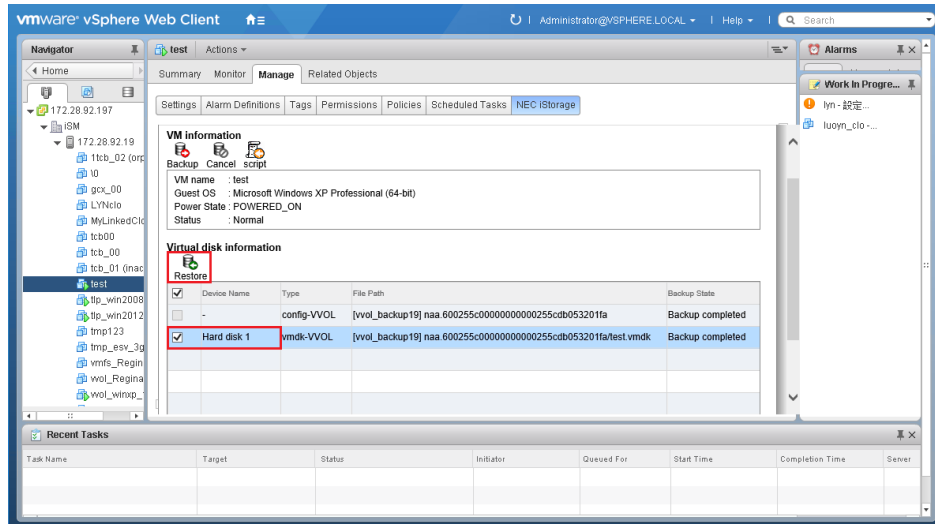

Figure F-20 Displaying the Restore Dialog Box

To restore config-VVOL, select the [Restore the config-VVOL] check box. Then, the check box corresponding to config-VVOL can be selected.

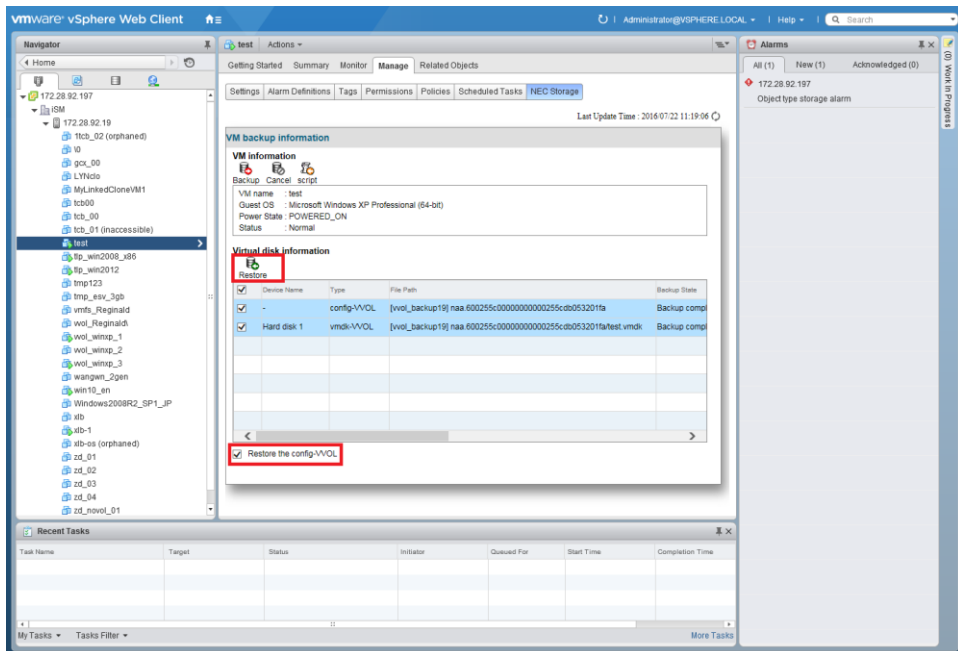

Figure F-21 Restore the config-VVOL Check Box

The Restore dialog box is displayed.

2. Select [From the Last Backup] or [From the Previous Backup] on the Restore dialog box.

Note the following on selecting the check box.

- The Last Backup will be selected when the device has only a backup.
- You do not need to restore config-VVOL in a normal case. Unless otherwise required, do not restore config-VVOL.
- Restoring will overwrite the data in the disk currently used.
- Before starting restore, shut down the VM or unmount the virtual disk of the restore destination from the OS. If the backup volume of the restore source is mounted on a host, unmount it as well.
- Make sure that the storage container has enough space because the VVOL may use more capacity depending on the difference in data between the VVOL of the restore destination and the backup volume of the restore source.

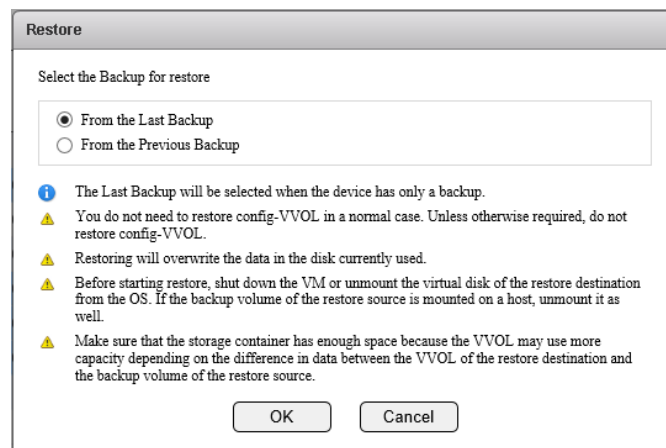

Figure F-22 Restore Dialog Box - Selecting the Target Backup

3. Click [OK] on the Restore dialog box to start the restore function. The following startup progress dialog box is displayed.

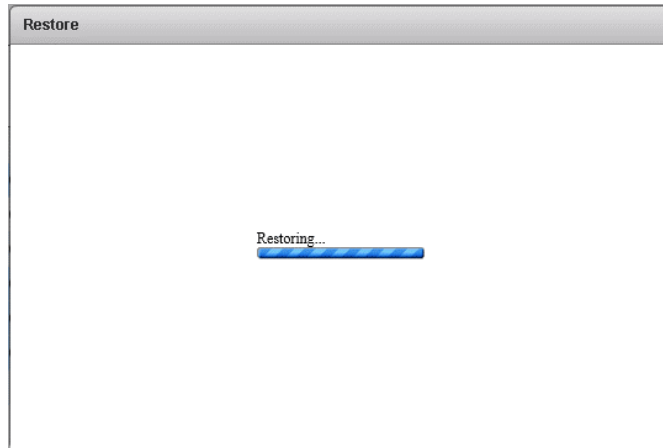

Figure F-23 Dialog Box Showing the Startup Progress

If restoring all virtual disks has started successfully, the following dialog box is displayed.



Figure F-24 Dialog Box Showing that Restoration Has Started

If it failed to start restoring some of the virtual disks, the following dialog box is displayed.



Figure F-25 Dialog Box Showing that Starting the Restoration of Some VMs Failed

If it failed to start restoring the virtual disks, the following dialog box is displayed.



Figure F-26 Dialog Box Showing that Starting the Restoration of VMs Failed



If the target VM has a snapshot, the virtual device cannot be restored. Delete all snapshots in the target VM and restore the virtual device.

## F.3.4 Generating a Backup Script

A script to back up the Virtual Volume VM can be generated by using the backup script generation function. A backup script uses the `onlineBackup.bat` command described in “Appendix E, Backup Operations and Messages”

A backup script is generated in the management server on which VASA Provider is running. If multiple VASA Provider instances are running in the management server, a backup script is generated in the VASA Provider instance that manages the disk array including the datastore (Storage Container) that saves the virtual disks of the VM to be backed up.

Be sure to use a backup script on the management server on which the backup script was generated.

1. Click the script generation icon (📄🔗).

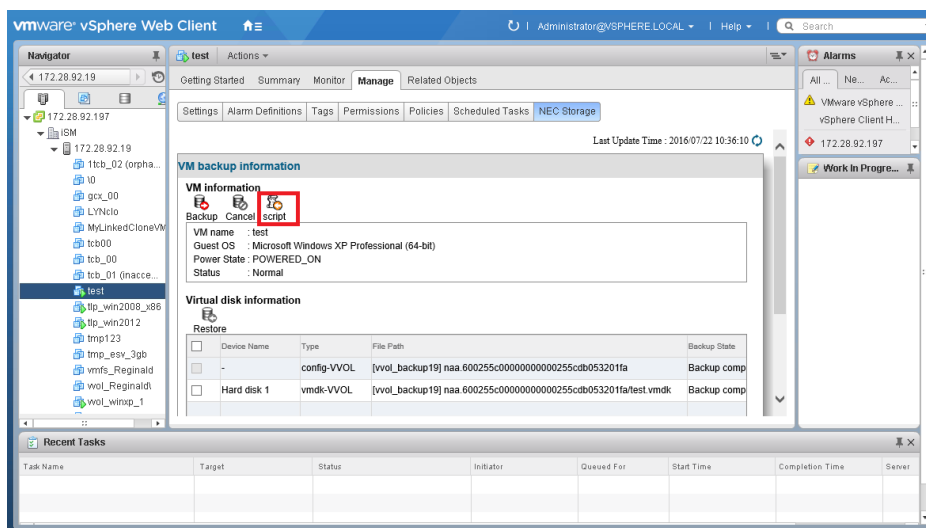

Figure F-27 Displaying the Generate Script Dialog Box

The Generate script dialog box is displayed.

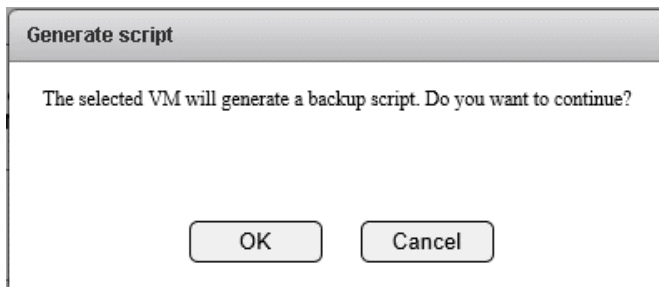

Figure F-28 Generate Script Dialog Box

2. Click [OK] on the Generate script dialog box to start generating a backup script. The following generation progress dialog box is displayed.

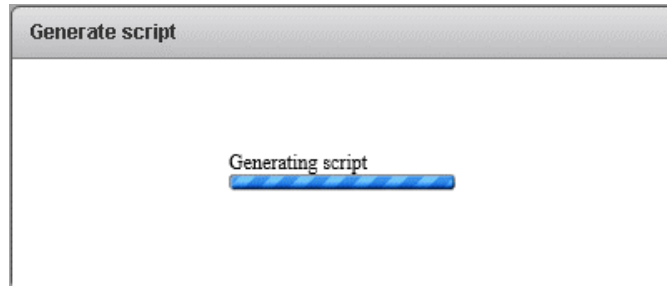

Figure F-29 Dialog Box Showing the Backup Script Generation Progress

If a backup script could not be generated, the following dialog box is displayed.

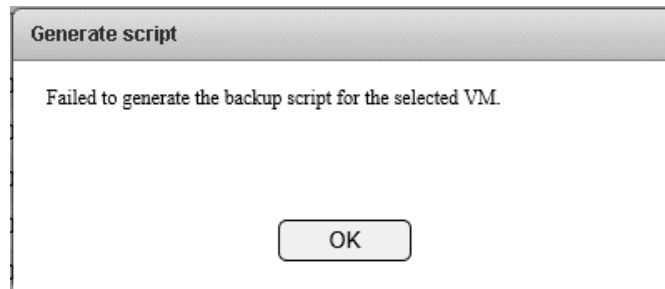

Figure F-30 Generate Script Dialog Box (When Failed)

If a backup script has been generated successfully, the following dialog box is displayed. The folder in which the backup script is generated is displayed on this dialog box.

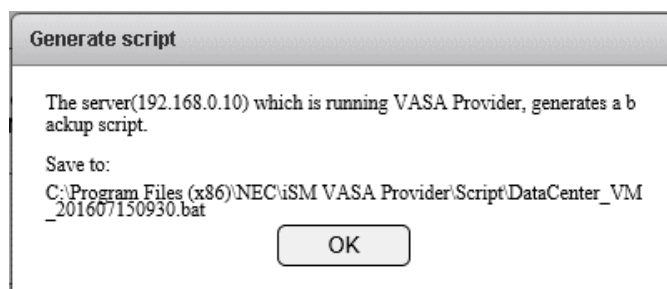

Figure F-31 Generate Script Dialog Box (When Succeeded)

## F.3.5 Identifying the Cause of a Logical Disk Failure by using the iSM Client

The cause of the logical disk failure in the disk array can be identified by using the iSM Client.

1. Start the iSM Client by clicking the link of [Last Backup LD] or [Previous Backup LD] of the logical disk in which a failure occurred in the [Virtual disk information] section on the Virtual Volume VM backup information screen.

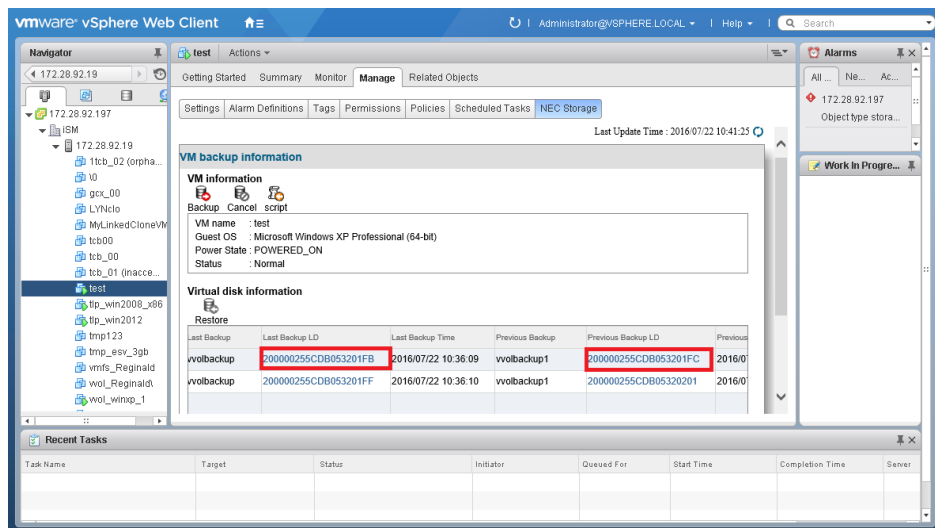

Figure F-32 Starting the iSM Client

2. When the disk array is managed by the iSM Server of the management server, specify the iSM Server settings in advance. For details, see 3.4.1 “Set iSM Server Information” in the “VMware vSphere Web Client Plug-in User’s Manual”. Check the displayed IP address and port number and click [Confirm] to start the iSM Client of the iSM Server on the management server.

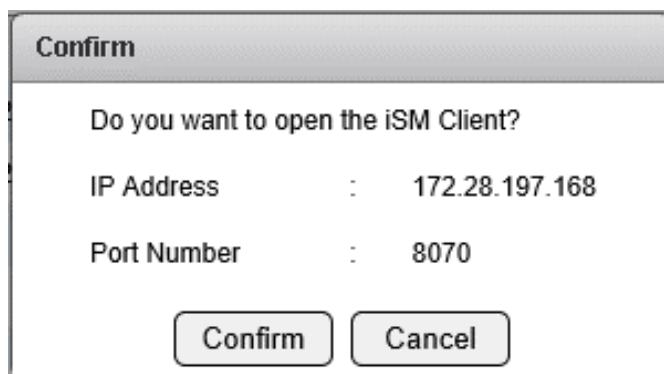

Figure F-33 Confirmation Dialog Box (iSM Server on the Management Server)

When the disk array is managed by the iSM Server of the disk array, it is not required to specify the iSM

Server settings. Check the displayed IP address and click [Confirm] to start the iSM Client. After the iSM Client has started, enter the user name and password.

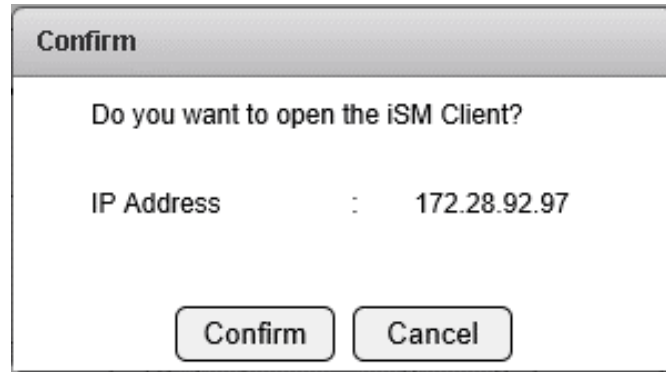

Figure F-34 Confirmation Dialog Box (iSM Server in the Disk Array)

For details about the operations to be performed on the iSM Client, see the “User’s Manual”.



The time of the client PC must synchronize with the time of the server in which VMware vSphere Web Client Plug-in is installed. If the times do not synchronize, the user name and password input may be prompted when starting the iSM client.



## F.4 Virtual Volume Information Screen

The Virtual Volume information screen displays the description of the Virtual Volume function and [List of VVOLs Not Used by VMs].

To display the Virtual Volume information screen, select vCenter Server on vSphere Web Client, select the [Manage] tab, and then select the [NEC Storage] subtab.

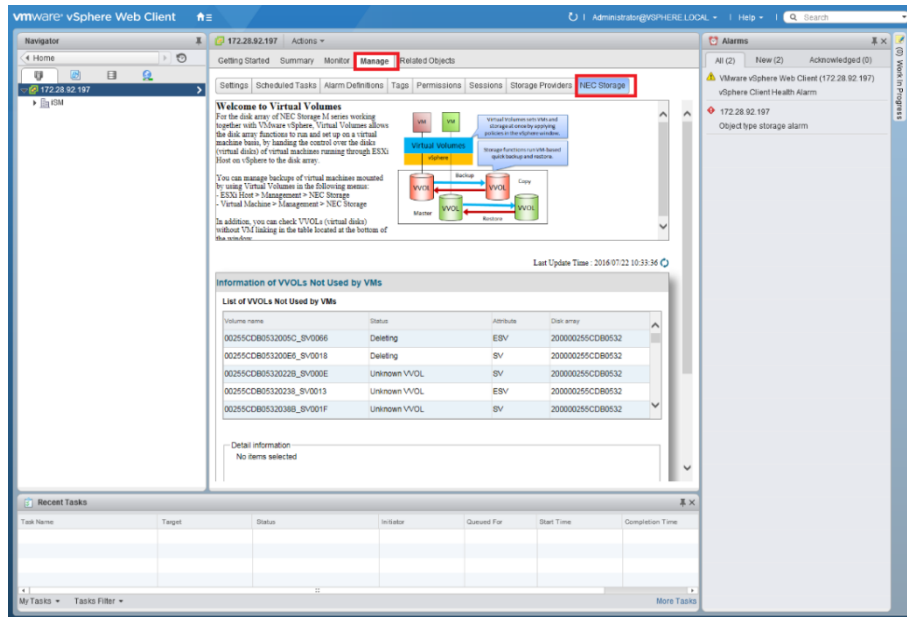

Figure F-35 Virtual Volume Information Screen

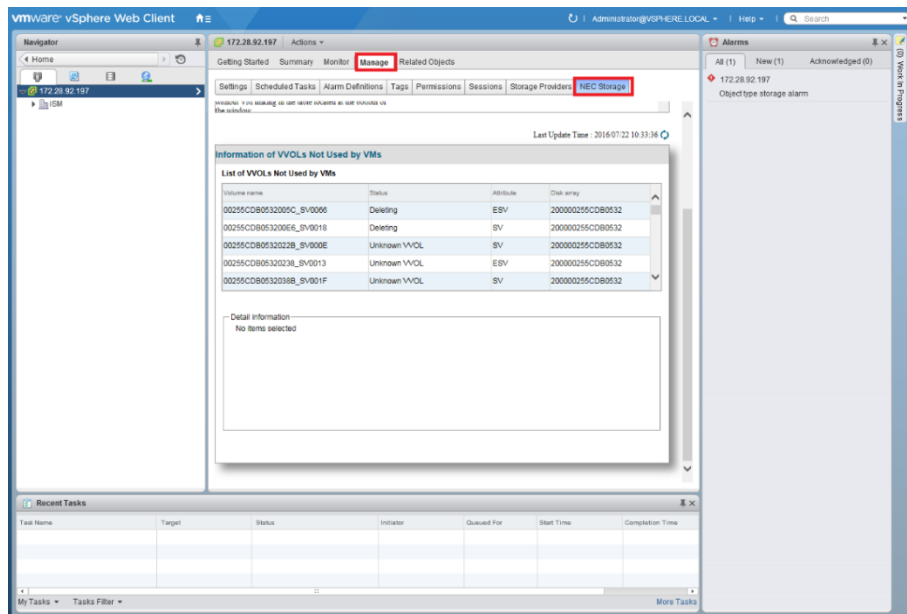

Figure F-36 Information of VVOLs Not Used by VMs

[Information of VVOLs Not Used by VMs] displays all VVOLs that are not recognized by vCenter Server and not used by VMs among the VVOLs in the disk array that is managed by VMware vSphere Web Client Plug-in.

There are the following four types of VVOLs that are not used by VMs. For details about each VVOL, see the description in [Detail information].

- Unknown VVOL (invalidVVOLList)

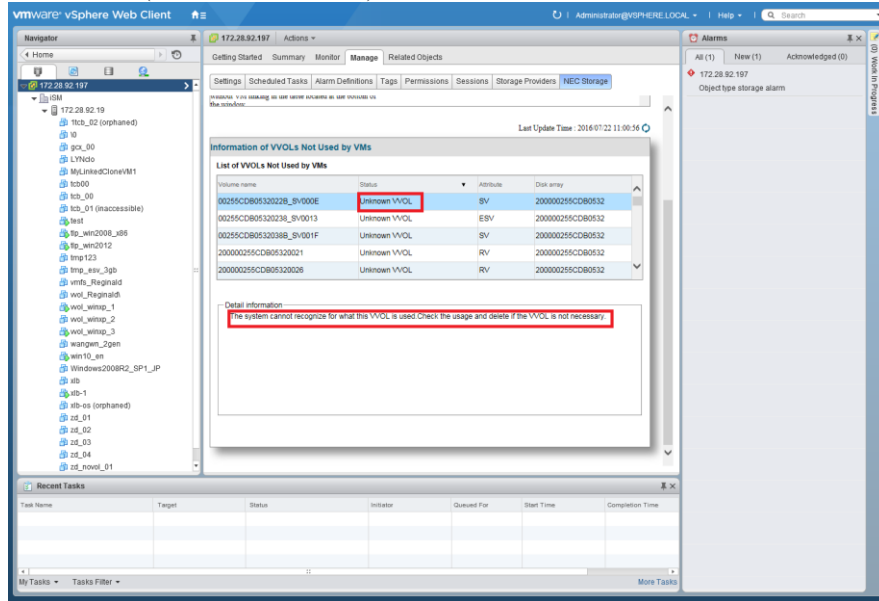

Figure F-37 Unknown VVOL

- Deleting (deletingVVOL)

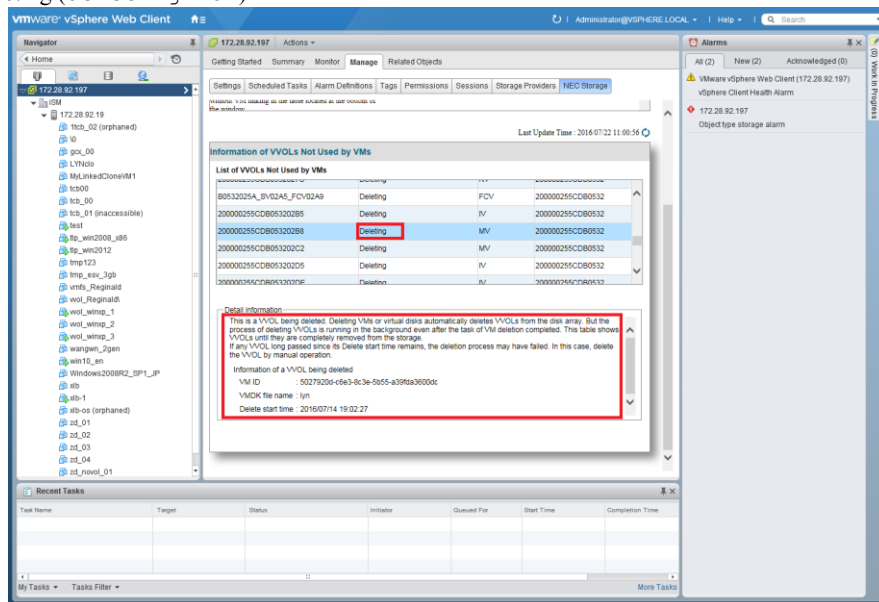

Figure F-38 VVOL Being Deleted

- Cloning (cloningVVOL)

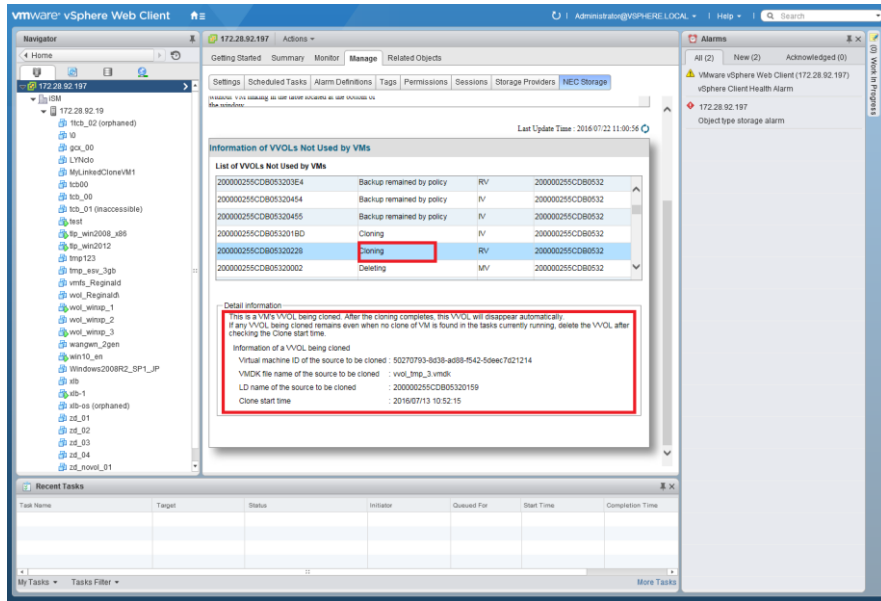

Figure F-39 VVOL Being Cloned

- Backup remained by policy (rvVVOLLiist)

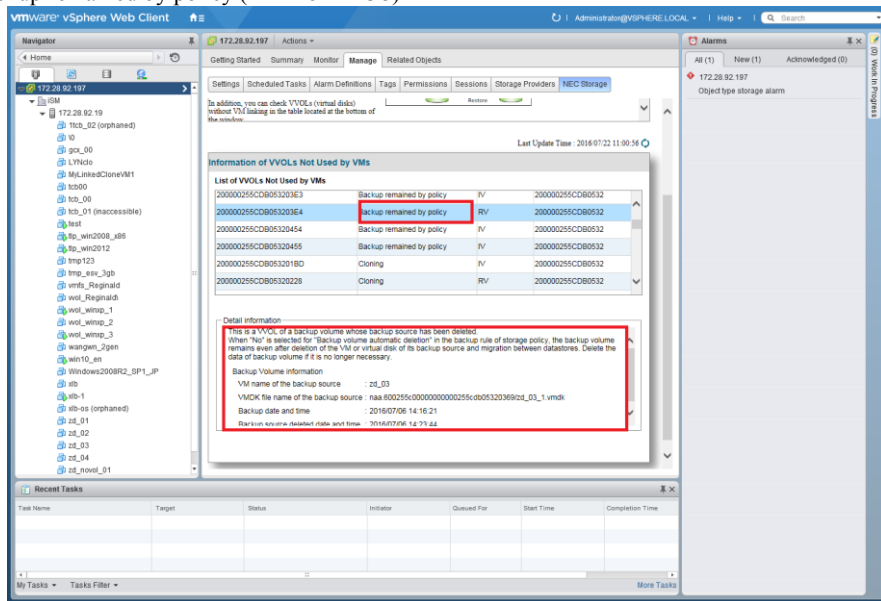



Figure F-40 Backup Remained by the Policy

### VVOL information

- (1) Volume  
The logical disk name is displayed.
- (2) Status  
The status of the logical disk is displayed.  
One of the following is displayed. For details about the character strings in ( ), see “A.2, Deletion of Unnecessary VVOLS”.
  - Unknown VVOL (`invalidVVOLList`)
  - Deleting (`deletingVVOL`)
  - Cloning (`cloningVVOL`)
  - Backup remained by policy (`rvVVOLList`)
- (3) Attribute  
The attribute of the logical disk is displayed.
- (4) Disk array  
The disk array name is displayed.

For the meaning and action to be taken for these volumes, see “A.2, Deletion of Unnecessary VVOLS”.

The last information update time is displayed on the upper right corner of the Virtual Volume information screen.

Click the update icon (  ) to update the information displayed on the screen.



Backup data might be stored in an unknown VVOL. Check the usage and delete unnecessary VVOLS.

## Appendix G License

### G.1 Apache log4j, Apache Commons Logging, Apache Tomcat

Apache License

Version 2.0, January 2004

<http://www.apache.org/licenses/>

#### TERMS AND CONDITIONS FOR USE, REPRODUCTION, AND DISTRIBUTION

##### 1. Definitions.

"License" shall mean the terms and conditions for use, reproduction, and distribution as defined by Sections 1 through 9 of this document.

"Licensor" shall mean the copyright owner or entity authorized by the copyright owner that is granting the License.

"Legal Entity" shall mean the union of the acting entity and all other entities that control, are controlled by, or are under common control with that entity. For the purposes of this definition,

"control" means (i) the power, direct or indirect, to cause the direction or management of such entity, whether by contract or otherwise, or (ii) ownership of fifty percent (50%) or more of the outstanding shares, or (iii) beneficial ownership of such entity.

"You" (or "Your") shall mean an individual or Legal Entity exercising permissions granted by this License.

"Source" form shall mean the preferred form for making modifications, including but not limited to software source code, documentation source, and configuration files.

"Object" form shall mean any form resulting from mechanical transformation or translation of a Source form, including but not limited to compiled object code, generated documentation, and conversions to other media types.

"Work" shall mean the work of authorship, whether in Source or Object form, made available under the License, as indicated by a copyright notice that is included in or attached to the work (an example is provided in the Appendix below).

"Derivative Works" shall mean any work, whether in Source or Object form, that is based on (or derived from) the Work and for which the editorial revisions, annotations, elaborations, or other modifications represent, as a whole, an original work of authorship. For the purposes of this License, Derivative Works shall not include works that remain separable from, or merely link (or bind by name) to the interfaces of, the Work and Derivative Works thereof.

"Contribution" shall mean any work of authorship, including the original version of the Work and any modifications or additions to that Work or Derivative Works thereof, that is intentionally submitted to Licensor for inclusion in the Work by the copyright owner or by an individual or Legal Entity authorized to submit on behalf of the copyright owner. For the purposes of this definition, "submitted" means any form of electronic, verbal, or written communication sent to the Licensor or its representatives, including but not limited to communication on electronic mailing lists, source code control systems, and issue tracking systems that are managed by, or on behalf of, the Licensor for the purpose of discussing and improving the Work, but excluding communication that is conspicuously marked or otherwise designated in writing by the copyright owner as "Not a Contribution."

"Contributor" shall mean Licensor and any individual or Legal Entity on behalf of whom a Contribution has been received by Licensor and subsequently incorporated within the Work.

2. Grant of Copyright License. Subject to the terms and conditions of this License, each Contributor hereby grants to You a perpetual, worldwide, non-exclusive, no-charge, royalty-free, irrevocable copyright license to reproduce, prepare Derivative Works of, publicly display, publicly perform, sublicense, and distribute the Work and such Derivative Works in Source or Object form.

3. Grant of Patent License. Subject to the terms and conditions of this License, each Contributor hereby grants to You a perpetual, worldwide, non-exclusive, no-charge, royalty-free, irrevocable

(except as stated in this section) patent license to make, have made, use, offer to sell, sell, import, and otherwise transfer the Work, where such license applies only to those patent claims licensable by such Contributor that are necessarily infringed by their

Contribution(s) alone or by combination of their Contribution(s) with the Work to which such Contribution(s) was submitted. If You institute patent litigation against any entity (including a

cross-claim or counterclaim in a lawsuit) alleging that the Work or a Contribution incorporated within the Work constitutes direct or contributory patent infringement, then any patent licenses granted to You under this License for that Work shall terminate as of the date such litigation is filed.

4. Redistribution. You may reproduce and distribute copies of the Work or Derivative Works thereof in any medium, with or without modifications, and in Source or Object form, provided that You meet the following conditions:

(a) You must give any other recipients of the Work or Derivative Works a copy of this License; and

(b) You must cause any modified files to carry prominent notices stating that You changed the files; and

(c) You must retain, in the Source form of any Derivative Works that You distribute, all copyright, patent, trademark, and attribution notices from the Source form of the Work, excluding those notices that do not pertain to any part of the Derivative Works; and

(d) If the Work includes a "NOTICE" text file as part of its distribution, then any Derivative Works that You distribute must include a readable copy of the attribution notices contained within such NOTICE file, excluding those notices that do not pertain to any part of the Derivative Works, in at least one of the following places: within a NOTICE text file distributed as part of the Derivative Works; within the Source form or documentation, if provided along with the Derivative Works; or, within a display generated by the Derivative Works, if and wherever such third-party notices normally appear. The contents of the NOTICE file are for informational purposes only and

do not modify the License. You may add Your own attribution notices within Derivative Works that You distribute, alongside or as an addendum to the NOTICE text from the Work, provided that such additional attribution notices cannot be construed as modifying the License.

You may add Your own copyright statement to Your modifications and may provide additional or different license terms and conditions for use, reproduction, or distribution of Your modifications, or for any such Derivative Works as a whole, provided Your use, reproduction, and distribution of the Work otherwise complies with the conditions stated in this License.

5. Submission of Contributions. Unless You explicitly state otherwise, any Contribution intentionally submitted for inclusion in the Work by You to the Licensor shall be under the terms and conditions of this License, without any additional terms or conditions.

Notwithstanding the above, nothing herein shall supersede or modify the terms of any separate license agreement you may have executed with Licensor regarding such Contributions.

6. Trademarks. This License does not grant permission to use the trade names, trademarks, service marks, or product names of the Licensor, except as required for reasonable and customary use in describing the origin of the Work and reproducing the content of the NOTICE file.

7. Disclaimer of Warranty. Unless required by applicable law or agreed to in writing, Licensor provides the Work (and each

Contributor provides its Contributions) on an "AS IS" BASIS, WITHOUT WARRANTIES OR CONDITIONS OF ANY KIND, either express or implied, including, without limitation, any warranties or conditions of TITLE, NON-INFRINGEMENT, MERCHANTABILITY, or FITNESS FOR A PARTICULAR PURPOSE. You are solely responsible for determining the appropriateness of using or redistributing the Work and assume any risks associated with Your exercise of permissions under this License.

8. Limitation of Liability. In no event and under no legal theory, whether in tort (including negligence), contract, or otherwise, unless required by applicable law (such as deliberate and grossly negligent acts) or agreed to in writing, shall any Contributor be liable to You for damages, including any direct, indirect, special,



incidental, or consequential damages of any character arising as a result of this License or out of the use or inability to use the

Work (including but not limited to damages for loss of goodwill, work stoppage, computer failure or malfunction, or any and all other commercial damages or losses), even if such Contributor has been advised of the possibility of such damages.

9. Accepting Warranty or Additional Liability. While redistributing the Work or Derivative Works thereof, You may choose to offer, and charge a fee for, acceptance of support, warranty, indemnity, or other liability obligations and/or rights consistent with this License. However, in accepting such obligations, You may act only on Your own behalf and on Your sole responsibility, not on behalf of any other Contributor, and only if You agree to indemnify, defend, and hold each Contributor harmless for any liability incurred by, or claims asserted against, such Contributor by reason of your accepting any such warranty or additional liability.

END OF TERMS AND CONDITIONS

APPENDIX: How to apply the Apache License to your work.

To apply the Apache License to your work, attach the following boilerplate notice, with the fields enclosed by brackets "[ ]" replaced with your own identifying information. (Don't include the brackets!) The text should be enclosed in the appropriate comment syntax for the file format. We also recommend that a file or class name and description of purpose be included on the same "printed page" as the copyright notice for easier identification within third-party archives.

Copyright [yyyy] [name of copyright owner]

Licensed under the Apache License, Version 2.0 (the "License");  
you may not use this file except in compliance with the License.

You may obtain a copy of the License at

<http://www.apache.org/licenses/LICENSE-2.0>

Unless required by applicable law or agreed to in writing, software distributed under the License is distributed on an "AS IS" BASIS,

WITHOUT WARRANTIES OR CONDITIONS OF ANY KIND, either express or implied.  
See the License for the specific language governing permissions and  
limitations under the License.

## G.2 Ganymed SSH-2 for Java License

---

Copyright (c) 2006 - 2010 Christian Plattner. All rights reserved.

Redistribution and use in source and binary forms, with or without  
modification, are permitted provided that the following conditions  
are met:

- a.) Redistributions of source code must retain the above copyright  
notice, this list of conditions and the following disclaimer.
- b.) Redistributions in binary form must reproduce the above copyright  
notice, this list of conditions and the following disclaimer in the  
documentation and/or other materials provided with the distribution.
- c.) Neither the name of Christian Plattner nor the names of its contributors may  
be used to endorse or promote products derived from this software  
without specific prior written permission.

THIS SOFTWARE IS PROVIDED BY THE COPYRIGHT HOLDERS AND CONTRIBUTORS "AS IS"  
AND ANY EXPRESS OR IMPLIED WARRANTIES, INCLUDING, BUT NOT LIMITED TO, THE  
IMPLIED WARRANTIES OF MERCHANTABILITY AND FITNESS FOR A PARTICULAR PURPOSE  
ARE DISCLAIMED. IN NO EVENT SHALL THE COPYRIGHT OWNER OR CONTRIBUTORS BE  
LIABLE FOR ANY DIRECT, INDIRECT, INCIDENTAL, SPECIAL, EXEMPLARY, OR  
CONSEQUENTIAL DAMAGES (INCLUDING, BUT NOT LIMITED TO, PROCUREMENT OF  
SUBSTITUTE GOODS OR SERVICES; LOSS OF USE, DATA, OR PROFITS; OR BUSINESS  
INTERRUPTION) HOWEVER CAUSED AND ON ANY THEORY OF LIABILITY, WHETHER IN  
CONTRACT, STRICT LIABILITY, OR TORT (INCLUDING NEGLIGENCE OR OTHERWISE)  
ARISING IN ANY WAY OUT OF THE USE OF THIS SOFTWARE, EVEN IF ADVISED OF THE  
POSSIBILITY OF SUCH DAMAGE.

This software includes work that was released under the following license:

Copyright (c) 2005 - 2006 Swiss Federal Institute of Technology (ETH Zurich),  
Department of Computer Science (<http://www.inf.ethz.ch>),  
Christian Plattner. All rights reserved.

Redistribution and use in source and binary forms, with or without modification, are permitted provided that the following conditions are met:

- a.) Redistributions of source code must retain the above copyright notice, this list of conditions and the following disclaimer.
- b.) Redistributions in binary form must reproduce the above copyright notice, this list of conditions and the following disclaimer in the documentation and/or other materials provided with the distribution.
- c.) Neither the name of ETH Zurich nor the names of its contributors may be used to endorse or promote products derived from this software without specific prior written permission.

THIS SOFTWARE IS PROVIDED BY THE COPYRIGHT HOLDERS AND CONTRIBUTORS "AS IS" AND ANY EXPRESS OR IMPLIED WARRANTIES, INCLUDING, BUT NOT LIMITED TO, THE IMPLIED WARRANTIES OF MERCHANTABILITY AND FITNESS FOR A PARTICULAR PURPOSE ARE DISCLAIMED. IN NO EVENT SHALL THE COPYRIGHT OWNER OR CONTRIBUTORS BE LIABLE FOR ANY DIRECT, INDIRECT, INCIDENTAL, SPECIAL, EXEMPLARY, OR CONSEQUENTIAL DAMAGES (INCLUDING, BUT NOT LIMITED TO, PROCUREMENT OF SUBSTITUTE GOODS OR SERVICES; LOSS OF USE, DATA, OR PROFITS; OR BUSINESS INTERRUPTION) HOWEVER CAUSED AND ON ANY THEORY OF LIABILITY, WHETHER IN CONTRACT, STRICT LIABILITY, OR TORT (INCLUDING NEGLIGENCE OR OTHERWISE) ARISING IN ANY WAY OUT OF THE USE OF THIS SOFTWARE, EVEN IF ADVISED OF THE POSSIBILITY OF SUCH DAMAGE.

The Java implementations of the AES, Blowfish and 3DES ciphers have been taken (and slightly modified) from the cryptography package released by "The Legion Of The Bouncy Castle".

Their license states the following:

Copyright (c) 2000 - 2004 The Legion Of The Bouncy Castle  
(<http://www.bouncycastle.org>)

Permission is hereby granted, free of charge, to any person obtaining a copy of this software and associated documentation files (the "Software"), to deal in the Software without restriction, including without limitation the rights to use, copy, modify, merge, publish, distribute, sublicense, and/or sell copies of the Software, and to permit persons to whom the Software is furnished to do so, subject to the following conditions:

The above copyright notice and this permission notice shall be included in all copies or substantial portions of the Software.

THE SOFTWARE IS PROVIDED "AS IS", WITHOUT WARRANTY OF ANY KIND, EXPRESS OR IMPLIED, INCLUDING BUT NOT LIMITED TO THE WARRANTIES OF MERCHANTABILITY, FITNESS FOR A PARTICULAR PURPOSE AND NONINFRINGEMENT. IN NO EVENT SHALL THE AUTHORS OR COPYRIGHT HOLDERS BE LIABLE FOR ANY CLAIM, DAMAGES OR OTHER LIABILITY, WHETHER IN AN ACTION OF CONTRACT, TORT OR OTHERWISE, ARISING FROM, OUT OF OR IN CONNECTION WITH THE SOFTWARE OR THE USE OR OTHER DEALINGS IN THE SOFTWARE.

### **G.3 The Legion of the Bouncy Castle**

---

Copyright (c) 2000 - 2013 The Legion of the Bouncy Castle Inc. (<http://www.bouncycastle.org>)

Permission is hereby granted, free of charge, to any person obtaining a copy of this software and associated documentation files (the "Software"), to deal in the Software without restriction, including without limitation the rights to use, copy, modify, merge, publish, distribute, sublicense, and/or sell copies of the Software, and to permit persons to whom the Software is furnished to do so, subject to the following conditions:

The above copyright notice and this permission notice shall be included in all copies or substantial portions of the Software.

THE SOFTWARE IS PROVIDED "AS IS", WITHOUT WARRANTY OF ANY KIND, EXPRESS OR IMPLIED, INCLUDING BUT NOT LIMITED TO THE WARRANTIES OF MERCHANTABILITY, FITNESS FOR A PARTICULAR PURPOSE AND NONINFRINGEMENT. IN NO EVENT SHALL THE AUTHORS OR COPYRIGHT HOLDERS BE LIABLE FOR ANY CLAIM, DAMAGES OR OTHER LIABILITY, WHETHER IN AN ACTION OF CONTRACT, TORT OR OTHERWISE, ARISING FROM, OUT OF OR IN CONNECTION WITH THE SOFTWARE OR THE USE OR OTHER DEALINGS IN THE SOFTWARE.

# Index

---

---

## A

adding a datastore .....	50
adding a server .....	53
adding a storage device .....	70
adding a virtual machine .....	52
adding and deleting a datastore .....	50
adding and deleting a server .....	53
adding and deleting a virtual machine .....	52
assigning a policy to a virtual machine .....	69

---

## C

collecting logs .....	78
configuration management .....	30
creating a clone of a virtual machine .....	61
creating a snapshot of a virtual machine .....	59
creating and deleting a snapshot of a virtual machine .....	57

---

## D

defining a backup policy .....	64
defining a QoS policy .....	68
deleting a datastore .....	51
deleting a server .....	53
deleting a snapshot of a virtual machine .....	59
deleting a virtual machine .....	52
difference from the conventional environment .....	2
displaying VVOL-related resources by using the configuration display command .....	42
displaying VVOL-related resources on the iSM Client screen .....	30
displaying VVOL-related resources on the vSphere Web Client .....	46

---

## E

expanding the capacity of a disk array .....	54
--	----

---

## I

installing VASA Provider .....	18
--------------------------------	----

---

## M

maintenance of VASA Provider .....	25
migrating a virtual machine .....	56

---

## O

operating a clone of a virtual machine .....	60
overview of Virtual Volume .....	1

---

## P

policy-based allocation .....	62
-------------------------------	----

---

## R

registering in vCenter Server .....	24
-------------------------------------	----

---

## S

setting up a disk array .....	4
setting up VASA Provider .....	18
setup .....	4
system configuration .....	3

---

## U

using the snapshot function .....	57
using the volume clone function .....	60

---

## V

Virtual Volume .....	1
----------------------	---