

ExpressCluster[®] X 2.1 *for Linux*

Installation and Configuration Guide

06/15/2009

1st Edition



Revision History

Edition	Revised Date	Description
First	2009/06/15	New manual

© Copyright NEC Corporation 2009. All rights reserved.

Disclaimer

Information in this document is subject to change without notice. No part of this document may be reproduced or transmitted in any form by any means, electronic or mechanical, for any purpose, without the express written permission of NEC Corporation.

Trademark Information

ExpressCluster® X is a registered trademark of NEC Corporation.

FastSync™ is a trademark of NEC Corporation.

Linux is a registered trademark and trademark of Linus Torvalds in the United State and other countries.

RPM is a trademark of Red Hat, Inc.

Intel, Pentium and Xeon are registered trademarks and trademarks of Intel Corporation.

Microsoft and Windows are registered trademarks of Microsoft Corporation in the United State and other countries.

Turbolinux is a registered trademark of Turbolinux. Inc.

VERITAS, VERITAS Logo and all other VERITAS product names and slogans are trademarks and registered trademarks of VERITAS Software Corporation.

Other product names and slogans written in this manual are trademarks and registered trademarks of their respective companies.

Table of Contents

Preface	ix
Who Should Use This Guide.....	ix
How This Guide is Organized.....	ix
ExpressCluster X Documentation Set	x
Conventions	xi
Contacting NEC.....	xii
Chapter 1 Determining a system configuration.....	15
Steps from configuring a cluster system to installing ExpressCluster	16
What is ExpressCluster?	17
ExpressCluster modules.....	18
Planning system configuration.....	19
Shared disk type and data mirror type.....	19
Example 1: configuration using a shared disk with 2 nodes.....	20
Example 2: configuration using mirror disks with 2 nodes	21
Example 3: configuration using mirror partitions on the disks for OS with 2 nodes.....	22
Example 4: configuration with 3 nodes.....	23
Example 5: configuration with 4 nodes.....	24
Example 6: Configuration of hybrid type with 3 nodes	25
Checking system requirements for each ExpressCluster module	26
Example of ExpressCluster (main module) hardware configuration	28
General requirements	28
Checking system requirements for the Builder.....	29
Verifying system requirements for the WebManager.....	30
Determining a hardware configuration	31
Settings after configuring hardware.....	32
Shared disk settings for disk resource (Required for disk resource).....	32
Shared disk settings for hybrid disk resource (Required for Replicator DR)	34
Partition settings for mirror disk resource (Required for the Replicator)	36
Partition settings for hybrid disk resource (when using Replicator DR)	38
Adjustment of the operating system startup time (Required)	39
Verification of the network settings (Required).....	41
Verification of the root file system (Required)	41
Verification of the firewall settings (Required).....	42
Server clock synchronization (Required).....	44
Chapter 2 Configuring a cluster system.....	45
Configuring a cluster system	46
Determining a cluster topology.....	47
Failover in uni-directional standby cluster.....	48
Failover in multi-directional standby cluster.....	49
Determining applications to be duplicated.....	50
Configuration relevant to the notes	50
Server applications	50
Note 1: Data recovery after an error.....	50
Note 2: Application termination.....	50
Note 3: Location to store the data	50
Note 4: Multiple application service groups	51
Note 5: Mutual interference and compatibility with applications	52
Solution to the problems relevant to the notes	52
How to determine a cluster topology	53
Planning a cluster configuration	54
Understanding group resources	55
Understanding monitor resources	56
Understanding heartbeat resources	58
Understanding network partition resolution resources	59

Chapter 3	Installing ExpressCluster	63
	Steps from Installing ExpressCluster to creating a cluster	64
	Setting up the ExpressCluster Server	65
	Installing the ExpressCluster RPM.....	65
	Installing the Builder on a Linux machine (Offline version).....	66
	Installing the Builder on a Windows machine (Offline version).....	67
	Starting the Builder.....	68
Chapter 4	Registering the license.....	69
	Registering the CPU license	70
	Registering the license by specifying the license file (for both product version and trial version).....	71
	Registering the license interactively from the command line (Product version).....	72
	Registering the node license	74
	Registering the node license by specifying the license file (for both product version and trial version).....	74
	Registering the node license interactively from the command line (Product version).....	76
Chapter 5	Creating the cluster configuration data using the Builder	79
	Creating the cluster configuration data.....	80
	Starting up the ExpressCluster X WebManager.....	81
	What is ExpressCluster X WebManager?.....	81
	Browsers supported by the WebManager.....	82
	Setting up JAVA runtime environment to a management PC.....	83
	Starting the WebManager.....	83
	Starting the Builder.....	84
	Checking the values to be configured in the cluster environment with 2 nodes.....	85
	Sample cluster environment	85
	Creating the configuration data of a 2-nodes cluster	89
	1. Creating a cluster.....	90
	1-1. Add a cluster	90
	1-2. Add the first server.....	91
	1-3. Add the second server	93
	2. Creating a failover group.....	95
	2-1. Add a group for management.....	95
	2-2. Add a group for operation	97
	2-3. Add a group resource (floating IP address).....	97
	2-4. Add a group resource (disk resource).....	98
	2-5. Add a group resource (mirror disk resource).....	98
	2-6. Add a group resource (exec resource).....	98
	3. Creating monitor resources.....	100
	3.1 Add a monitor resource (raw monitor resource).....	100
	3-2. Add a monitor resource (NIC Link Up/Down monitor for management group).....	100
	3-3. Add a monitor resource (NIC Link Up/Down monitor resource for management group).....	101
	Checking the values to be configured in the cluster environment with 3 nodes.....	102
	Sample cluster environment	102
	Creating the configuration data of a 3-nodes cluster	107
	1. Creating a cluster.....	109
	1-1. Add a cluster	109
	1-2. Add the first server.....	109
	1-3. Add the second server	112
	1-4. Add the third server.....	113
	2. Creating a failover group.....	115
	2-1. Add a group for management.....	115
	2-2. Add a group for operation	117
	2-3. Add a group resource (floating IP address).....	117
	2-4. Add a group resource (mirror disk resource).....	118
	2-5. Add a group resource (exec resource).....	118
	2-6 Add a group for operation 2	119
	2-7. Add a group resource (floating IP address).....	120
	2-8. Add a group resource (mirror disk resource).....	121
	2-9. Add a group resource (exec resource).....	121
	3. Creating monitor resources.....	123
	3.1 Add a monitor resource (raw monitor resource).....	123

3.2 Add a monitor resource (raw monitor resource).....	123
3-3. Add a monitor resource (NIC Link Up/Down monitor resource for management group)	123
3-4. Add a monitor resource (NIC Link Up/Down monitor resource for operation 1)	124
3-5. Add a monitor resource (NIC Link Up/Down monitor resource for operation 2)	124
Checking the values to be configured in the cluster environment with 3 nodes (hybrid type)	126
Sample cluster environment	126
Creating the configuration data of a 3-nodes cluster (hybrid type).....	130
1. Creating a cluster	132
1-1. Add a cluster	132
1-2. Add the first server	133
1-3. Add the second server.....	135
1-4. Add the third server	137
2. Creating a server group.....	139
2-1. Create the first server group.....	139
2-2. Create the second server group	139
3. Creating a failover group	141
3-1. Add a group for management	141
3-2. Add a group for operation.....	143
3-3. Configure a server group	143
3-4. Add a group resource (floating IP address).....	144
3-5. Add a group resource (hybrid disk resource).....	145
3-6. Add a group resource (exec resource).....	145
4. Add a monitor resources	147
4.1 Add a monitor resource (disk monitor)	147
4-2. Add a monitor resource (NIC Link Up/Down monitor for management group).....	147
4-3. Add a monitor resource (NIC Link Up/Down monitor resource for management group)	147
5. Modify a cluster properties	148
Saving the cluster configuration data.....	150
Saving the cluster configuration data in the file system (Linux).....	150
Saving the cluster configuration data in the file system (Windows)	151
Saving the cluster configuration data on a floppy disk (Linux).....	152
Saving the cluster configuration data on a floppy disk (Windows).....	153
Creating a cluster	154
How to create a cluster.....	154
Chapter 6 Verifying a cluster system	155
Verifying operations using the WebManager	156
Verifying operation by using commands	158
Chapter 7 Modifying the cluster configuration data.....	161
Modifying the cluster configuration data.....	162
Add the server	162
Add a group	163
Add a group resource	163
Add a monitor resource.....	163
Modifying the cluster configuration data by using the ExpressCluster Builder (online version).....	163
Modifying the cluster configuration data by using the ExpressCluster Builder (offline version)	164
Reflecting the cluster configuration data	165
Online version Builder.....	166
Uploading data only	166
Uploading data and restarting the WebManager	166
Uploading data after suspending a cluster.....	166
Uploading data after stopping a cluster	166
Shutting down and restarting a cluster after uploading data.....	166
Uploading data after stopping mirror agents	167
Offline version Builder	167
Uploading data only	167
Uploading data and restarting the WebManager	167
Uploading data after suspending a cluster.....	168
Uploading data after stopping a cluster	168
Shutting down and restarting a cluster after uploading data.....	169
Uploading data after stopping mirror agents	170
Notes for using the offline Builder	171

Notes for changing cluster configuration data using a floppy disk	171
Uploading the cluster configuration data using a floppy disk	171
Backing up the cluster configuration data using a floppy disk	172
Uploading the cluster configuration data when a floppy disk is not available for use	173
Backing up the cluster configuration data when a floppy disk is not available for use	173
Chapter 8 Verifying operation	177
Operation tests	178
Backup procedures	182
Backing up while ExpressCluster is active	182
Backing up while ExpressCluster is inactive	182
Backing up while ExpressCluster is inactive ~ For Replicator or Replicator DR ~	183
Restoration procedures	184
Restoring the file system containing the /opt/nec/clusterpro directory	184
Restoring the data on the shared disk	186
Restoring the data on the mirror disk or the hybrid disk	187
Chapter 9 Preparing to operate a cluster system	189
Operating the cluster system	190
Activating a cluster	190
Shutting down a cluster and server	190
Shutting down the entire cluster	190
Shutting down a server	190
Suspending ExpressCluster	191
Stopping the ExpressCluster daemon	191
Disabling the ExpressCluster daemon	191
Enabling the disabled ExpressCluster daemon	192
Checking the log collecting procedure	193
Collecting logs by using the WebManager	193
Chapter 10 Uninstalling and reinstalling ExpressCluster	195
Uninstallation	196
Uninstalling the ExpressCluster Server	196
Deleting the Java user policy file of ExpressCluster X Builder (Online version)	197
Uninstalling the ExpressCluster X Builder (Offline version)	197
Reinstallation	198
Reinstalling the ExpressCluster Server	198
Appendix A. Troubleshooting	201
Errors messages when installing the ExpressCluster X Builder	201
Error messages when uninstalling the ExpressCluster X Builder	201
Error messages when installing the ExpressCluster Server	201
Error messages when uninstalling the ExpressCluster Server	202
Troubleshooting for licensing	202
Appendix B. Glossary	205
Appendix C. Index	207

Preface

Who Should Use This Guide

The *Installation and Configuration Guide* is intended for system engineers and administrators who want to build, operate, and maintain a cluster system. Instructions for designing, installing, and configuring a cluster system with ExpressCluster are covered in this guide.

How This Guide is Organized

- Section I **Configuring a cluster system****
Determines cluster hardware configuration required before installing ExpressCluster and how to create the cluster configuration data with the ExpressCluster X Builder before installing ExpressCluster.
- Chapter 1 **Determining a system configuration****
Provides instructions for how to verify system requirements and determine the system configuration.
- Chapter 2 **Configuring a cluster system****
Helps you understand how to configure a cluster system.
- Section II **Installing ExpressCluster****
Install ExpressCluster to the server machine and configure a cluster system using the cluster configuration data that you have created in Section I. Then run the operation tests and verify if the system operates successfully.
- Chapter 3 **Installing ExpressCluster****
Provides instructions for how to install ExpressCluster.
- Chapter 4 **Registering the license****
Provides instructions for how to register the license.
- Chapter 5 **Creating the cluster configuration data using the Builder****
Provides instructions for how to create the cluster configuration data with the ExpressCluster X Builder.
- Chapter 6 **Verifying a cluster system****
Verify if the cluster system that you have configured operates successfully.
- Chapter 7 **Modifying the cluster configuration data****
Provides instructions for how to modify the cluster configuration data.
- Section III **Evaluation before operating a cluster system****
Evaluate the system before start operating the cluster. Verify the required settings after checking the behavior of the cluster system. Instruction on how to uninstall and reinstall ExpressCluster is provided as well.
- Chapter 8 **Verifying operation****
Run the pseudo-failure test and adjust the parameters.
- Chapter 9 **Preparing to operate a cluster system****
Provides information on what you need to consider before actually start operating ExpressCluster.
- Chapter 10 **Uninstalling and reinstalling ExpressCluster****
Provides instructions for how to uninstall and reinstall ExpressCluster.
- Appendix A **Troubleshooting****
- Appendix B **Glossary****
- Appendix C **Index****

ExpressCluster X Documentation Set

The ExpressCluster X manuals consist of the following four guides. The title and purpose of each guide is described below:

Getting Started Guide

This guide is intended for all users. The guide covers topics such as product overview, system requirements, and known problems.

Installation and Configuration Guide

This guide is intended for system engineers and administrators who want to build, operate, and maintain a cluster system. Instructions for designing, installing, and configuring a cluster system with ExpressCluster are covered in this guide.

Reference Guide

This guide is intended for system administrators. The guide covers topics such as how to operate ExpressCluster, function of each module, maintenance-related information, and troubleshooting. The guide is supplement to the *Installation and Configuration Guide*.

CLUSTERPRO X Integrated WebManager Administrator's Guide

This guide is intended for system administrators who manage cluster system using ExpressCluster with ExpressCluster Integrated WebManager and for system engineers who introduce the Integrated WebManager. In this guide, details on required items for introducing the cluster system using the Integrated WebManager are explained in accordance with the actual procedures.

Conventions

In this guide, **Note**, **Important**, **Related Information** are used as follows:

Note:

Used when the information given is important, but not related to the data loss and damage to the system and machine.

Important:

Used when the information given is necessary to avoid the data loss and damage to the system and machine.

Related Information:

Used to describe the location of the information given at the reference destination.

The following conventions are used in this guide.

Convention	Usage	Example
Bold	Indicates graphical objects, such as fields, list boxes, menu selections, buttons, labels, icons, etc.	In User Name , type your name. On the File menu, click Open Database .
Angled bracket within the command line	Indicates that the value specified inside of the angled bracket can be omitted.	<code>clpstat -s[-h <i>host_name</i>]</code>
#	Prompt to indicate that a Linux user has logged on as root user.	<code># clpcl -s -a</code>
Monospace (courier)	Indicates path names, commands, system output (message, prompt, etc), directory, file names, functions and parameters.	<code>/Linux/2.1/eng/server/</code>
Monospace bold (courier)	Indicates the value that a user actually enters from a command line.	Enter the following: <code># clpcl -s -a</code>
<i>Monospace italic</i> (courier)	Indicates that users should replace italicized part with values that they are actually working with.	<code>rpm -i expressclsbuilder -<version_number>- <release_number>.i686.rpm</code>

Contacting NEC

For the latest product information, visit our website below:

<http://www.nec.co.jp/pfsoft/clusterpro/clp/overseas.html>

Section I Configuring a cluster system

Before installing ExpressCluster, it is important to plan your cluster system considering the hardware configuration and the operation requirements and needs. This section describes how to determine the hardware configuration required before installing ExpressCluster and how to create the cluster configuration data with the ExpressCluster X Builder.

- Chapter 1 Determining a system configuration
- Chapter 2 Configuring a cluster system

Chapter 1 **Determining a system configuration**

This chapter provides instructions for determining the cluster system configuration that uses ExpressCluster.

This chapter covers:

- Steps from configuring a cluster system to installing ExpressCluster 16
- What is ExpressCluster? 17
- Planning system configuration 19
- Checking system requirements for each ExpressCluster module 26
- Example of ExpressCluster (main module) hardware configuration 28
- Checking system requirements for the Builder 29
- Verifying system requirements for the WebManager 30
- Determining a hardware configuration 31
- Settings after configuring hardware 32

Steps from configuring a cluster system to installing ExpressCluster

Before you set up a cluster system that uses ExpressCluster, you should carefully plan the cluster system with due consideration for factors such as hardware requirements, software to be used, and the way the system is used. When you have built the cluster, check to see if the cluster system is successfully set up before you start its operation.

This guide explains how to create a cluster system with ExpressCluster through step-by-step instructions. Read each chapter by actually executing the procedures to install the cluster system. Following is the steps to take from designing the cluster system to operating ExpressCluster:

The following is the procedure for configuring a cluster system to run an operation test:

Configuring a cluster system (Section I)

Prepare for installing ExpressCluster. Determine the hardware configuration and the setting information of a cluster system to be constructed.

- Step 1 Determining a system configuration (Chapter 1)
- Step 2 Configuring a cluster system (Chapter 2)

Installing and configuring ExpressCluster X (Section II)

Install ExpressCluster to server machines, create a configuration data file by using setting information created on section I, and construct a cluster. After that, verify that a cluster system operates normally.

- Step 3 Installing ExpressCluster (Chapter 3)
- Step 4 Registering the license (Chapter 4)
- Step 5 Creating the cluster configuration data using the Builder (Chapter 5)
- Step 6 Verifying a cluster system (Chapter 6)
- Step 7 Modifying the cluster configuration data (Chapter 7)

Evaluation before operating a cluster system (Section III)

Perform an evaluation required before starting the ExpressCluster operation. Test the operations of a constructed cluster system, and then check what should be checked before starting the ExpressCluster operation. On the last part of this section, how to uninstall and reinstall ExpressCluster is described.

- Step 8 Verifying operation (Chapter 8)
- Step 9 Preparing to operate a cluster system (Chapter 9)
- Step 10 Uninstalling and reinstalling ExpressCluster (Chapter 10)

Related Information:

Refer to the *Reference Guide* as you need when operating ExpressCluster by following the procedures introduced in this guide. See the *Getting Started Guide* for installation requirements.

What is ExpressCluster?

ExpressCluster is software that enhances availability and expandability of systems by a redundant (clustered) system configuration. The application services running on the active server are automatically taken over to the standby server when an error occurs on the active server.

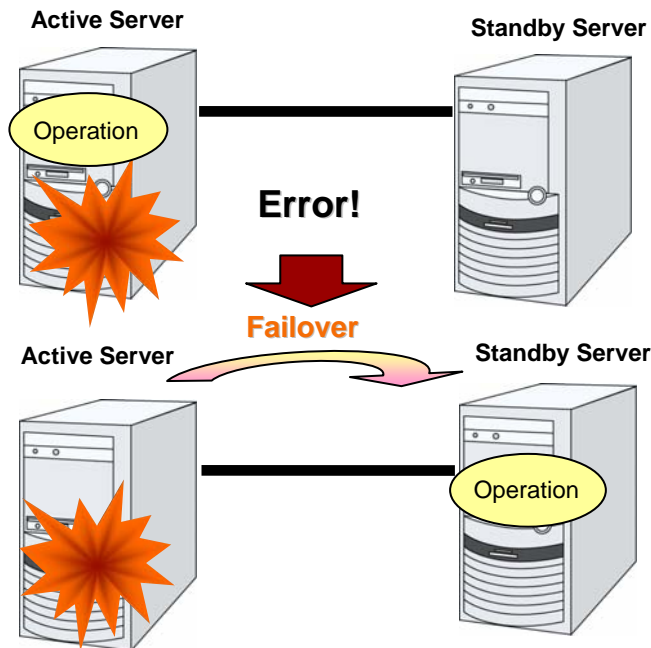

The following can be achieved by installing a cluster system that uses ExpressCluster.

- ◆ High availability

The down time is minimized by automatically failing over the applications and services to a “healthy” server when one of the servers which configure a cluster stops.

- ◆ High expandability

An expandable database platform can be provided by supporting a parallel database up to 32 servers.

Related Information:

For details on ExpressCluster, refer to Section I “Introducing ExpressCluster” in the *Getting Started Guide*.

ExpressCluster modules

ExpressCluster consists of following three modules:

◆ **ExpressCluster Server**

The main module of ExpressCluster and has all high availability functions of the server. Install this module on each server constituting the cluster.

◆ **ExpressCluster X WebManager**

A tool to manage ExpressCluster operations and uses a Web browser as a user interface. The WebManager is installed in ExpressCluster Server, but it is distinguished from the ExpressCluster Server because the WebManager is operated through a Web browser on the management PC.

◆ **ExpressCluster X Builder**

A tool for editing the cluster configuration data. The Builder also uses a Web browser as a user interface the same way as the WebManager. The Builder needs to be installed separately from the ExpressCluster Server on the machine where you use the Builder. Two types of the Builders, online and offline versions are available. The offline Builder needs to be installed on a terminal where you use the Builder.

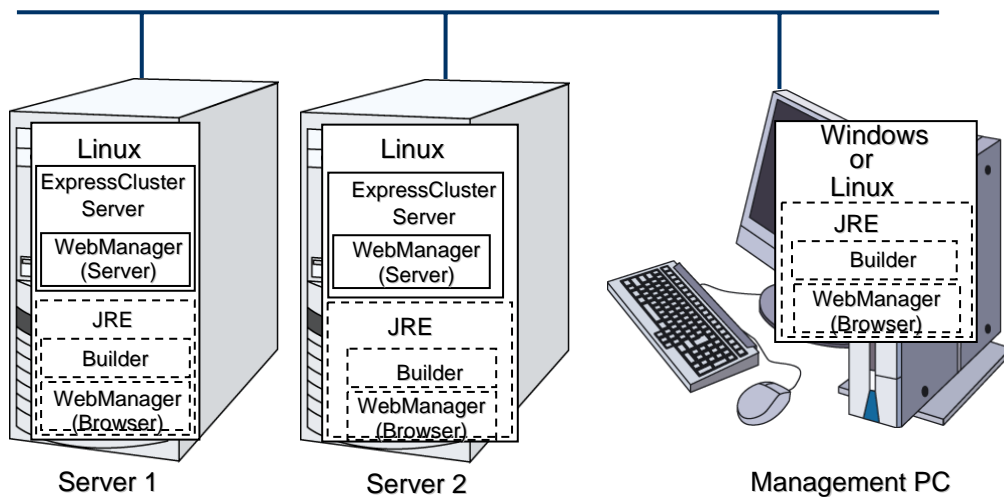

The ExpressCluster X Builder and WebManager can run on any Windows or Linux machines as long as Java Runtime Environment (JRE) is installed. This is because the Builder and the WebManager are Java applets that run on Java VM.

The Builder and the WebManager can be used on a server in the cluster as long as JRE is installed.

Planning system configuration

You need to determine an appropriate hardware configuration to install a cluster system that uses ExpressCluster. The configuration examples of ExpressCluster are shown below.

Related Information:

For latest information on system requirements, refer to the *Getting Started Guide*.

Shared disk type and data mirror type

There are two types of system configurations: shared disk type and data mirror type, which has a subset, hybrid type.

◆ **Shared disk type**

When the shared disk type configuration is used, application data is stored on a shared disk that is physically connected to servers, by which access to the same data after failover is ensured.

You can make settings that block the rest of the server from accessing the shared disk when one server is using a specific space of the shared disk.

The shared disk type is used in a system such as a database server where a large volume of data is written because performance in writing data does decrease.

◆ **Data mirror type**

When the data mirror type configuration is used, application data is always mirrored between disks of two servers, by which access to the same data after failover is ensured.

When data is written on the active server, writing the data is considered as being completed after the data is written on the standby server simultaneously.

Performance in writing decreases because data is written on the standby server. However, cost of system can be reduced since no external disk such as a shared disk is necessary, and the cluster can be achieved only by disks on servers.

◆ **Hybrid type**

This configuration is a combination of the shared disk type and the mirror disk type. By mirroring the data on the shared disk, the data is placed in the third server, which prevents the shared disk being a single point of failure. This method is a subset of the data mirror type.

Data writing performance, operational topology and precautions of the mirror disk type apply to the hybrid type.

The following pages show examples of the shared disk type, mirror disk type and hybrid type configurations. Use these examples to design and set up your system.

Example 1: configuration using a shared disk with 2 nodes

The most commonly used system configuration:

- ◆ Different models can be used for servers.
- ◆ Use cross cables for interconnection. (A dedicated HUB can be used for connection as in the case with the 4-nodes configuration)
- ◆ Connect COM (RS-232C) ports using a cross cable.

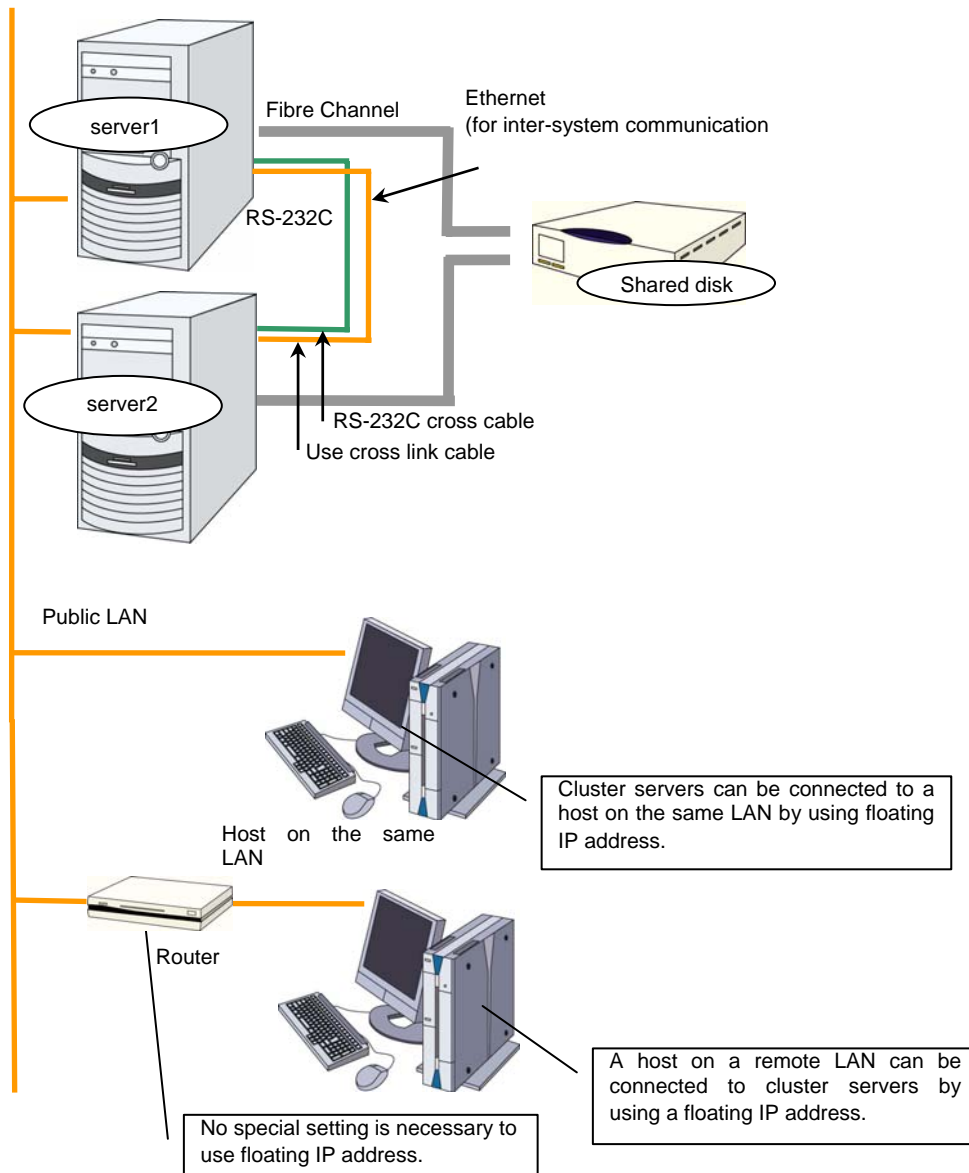

Example 2: configuration using mirror disks with 2 nodes

- ◆ Different models can be used for servers. However, servers should have the same architecture.
- ◆ Use cross cables for interconnection. Use cross cables for the interconnection between the mirror disks (mirror disk connect). Do not connect a HUB.
- ◆ Connect COM (RS-232C) ports using cross cables.

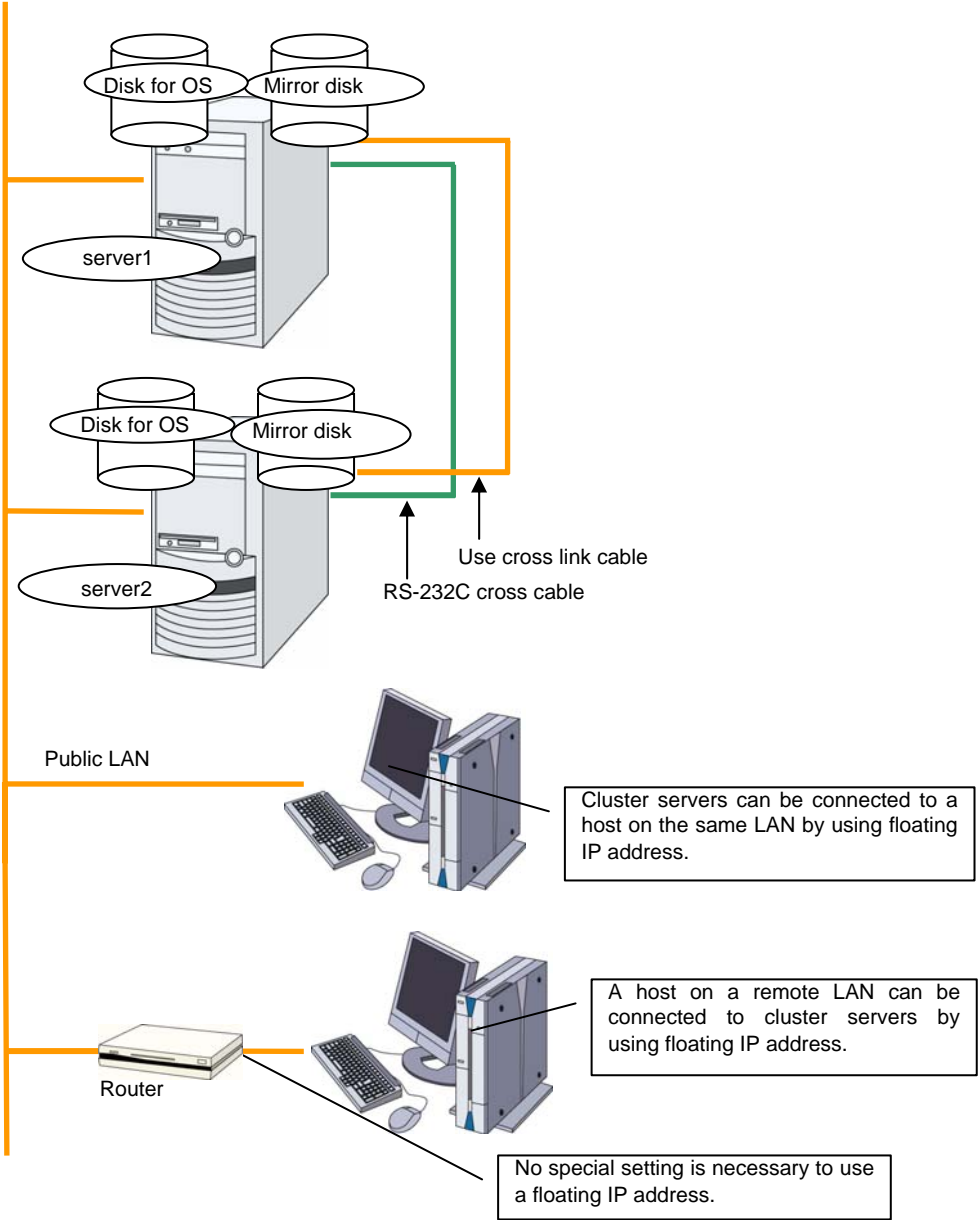

Example 3: configuration using mirror partitions on the disks for OS with 2 nodes

- ◆ As shown below, a mirroring partition can be created on the disk used for the OS.

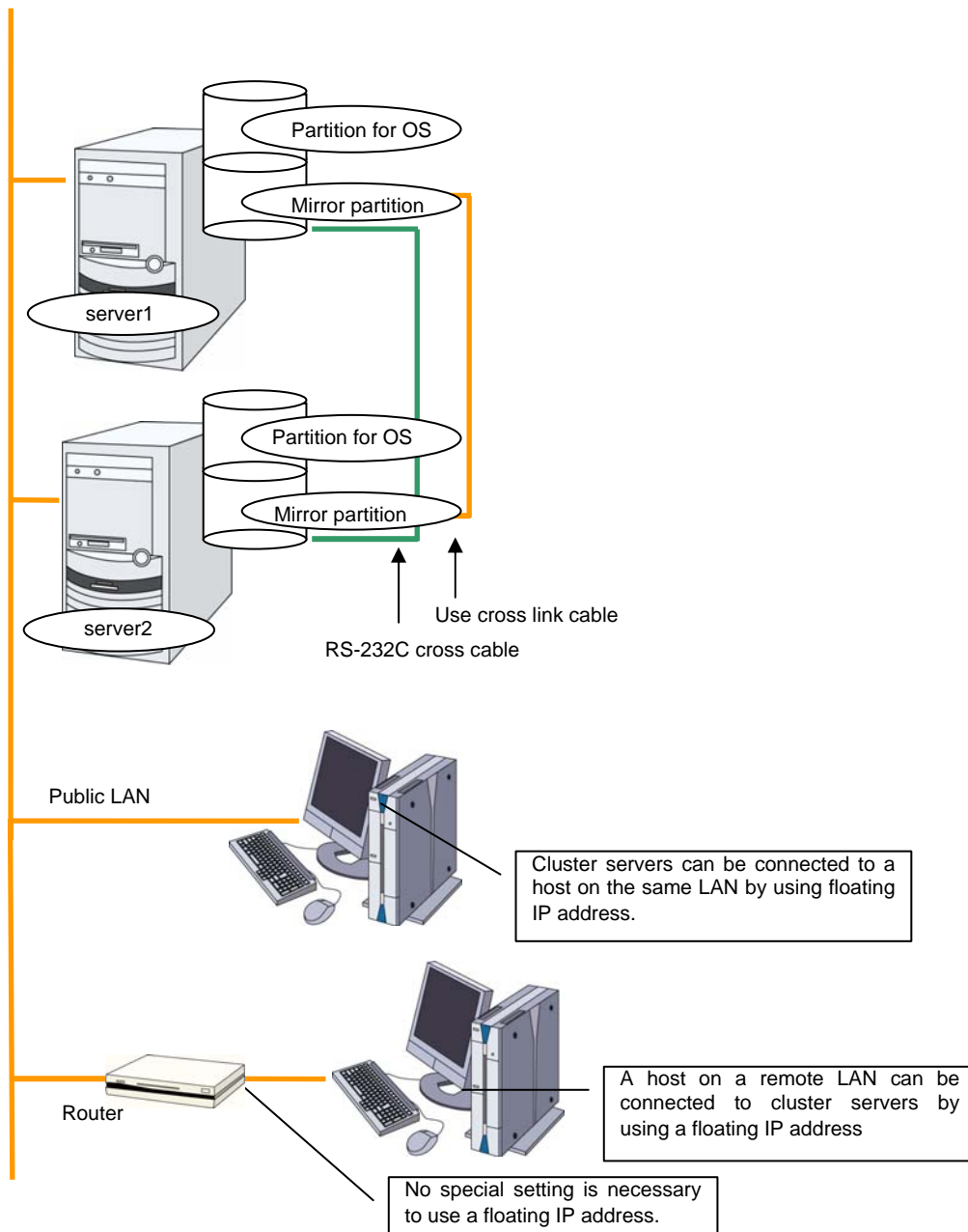

Related Information:

For mirror partition settings, refer to Chapter 5, “Group resource details” in the *Reference Guide*.

Example 4: configuration with 3 nodes

- ◆ For 3 nodes configuration, prepare two mirror disks on a standby server where mirror resources are integrated (in the figure below, server3).
- ◆ Install a dedicated HUB for LAN used for interconnection and mirror disk connection.
- ◆ For the HUB, use the high-speed HUB.
- ◆ It is not necessary to establish connectivity between servers using the connect COM (RS-232C).

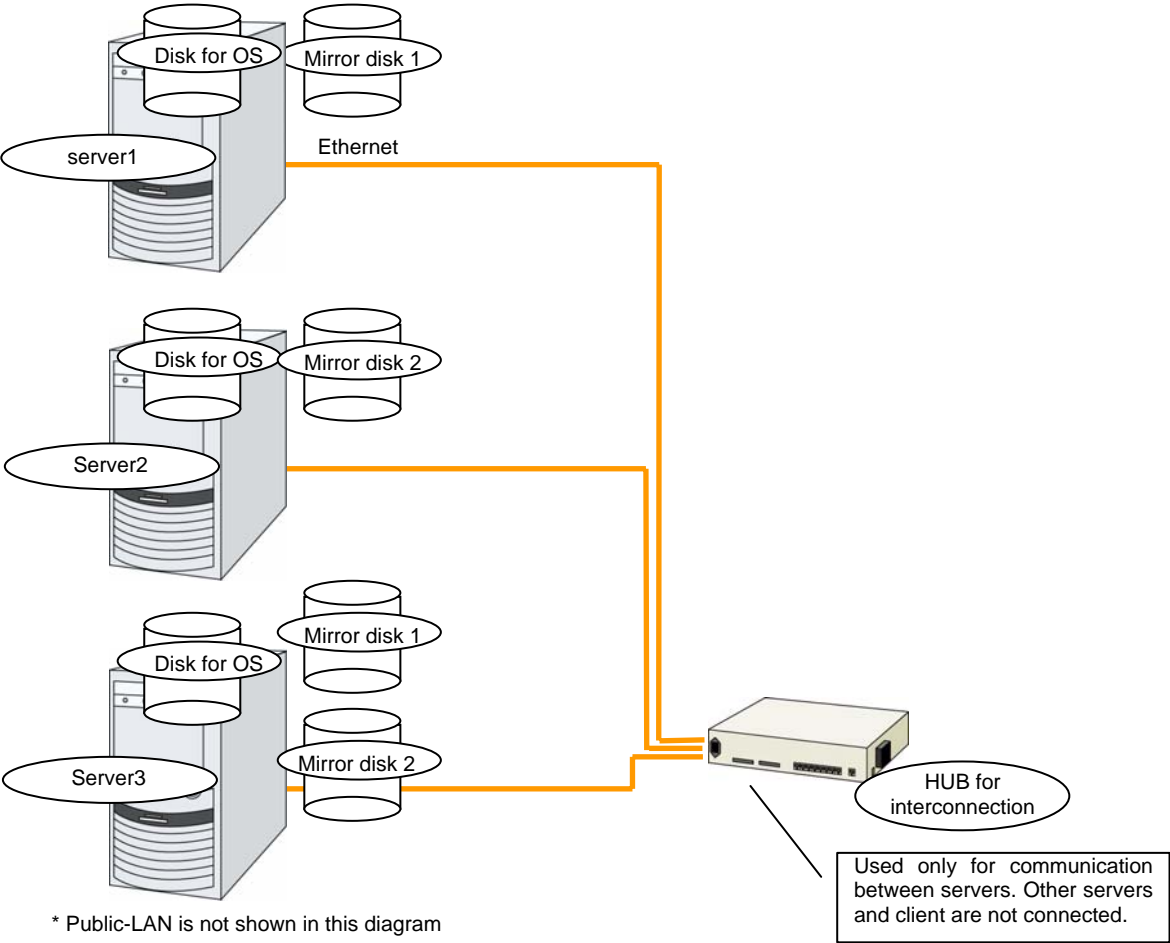

Example 5: configuration with 4 nodes

- ◆ As is the case with 2 nodes, connect a shared disk.
- ◆ Install a dedicated HUB for interconnection.
- ◆ It is not necessary to establish connectivity between servers using the connect COM (RS-232C).

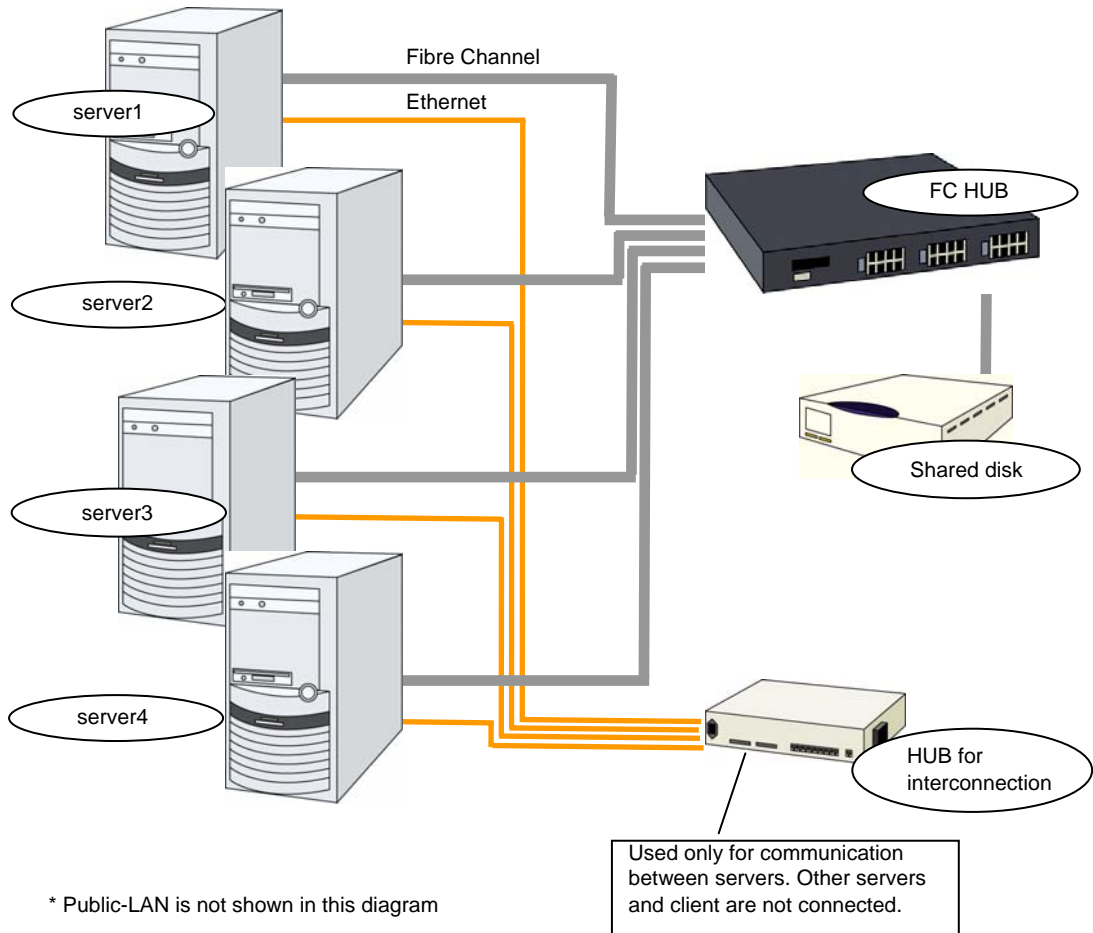

Example 6: Configuration of hybrid type with 3 nodes

This is a configuration with three nodes, which consists of two nodes connected to the shared disk and one node with the disk to be mirrored.

- ◆ Different models can be used for servers but the servers must be configured in the same architecture.
- ◆ Install a dedicated HUB for interconnection and LAN of mirror disk connect.
- ◆ For the HUB, use a fast HUB.

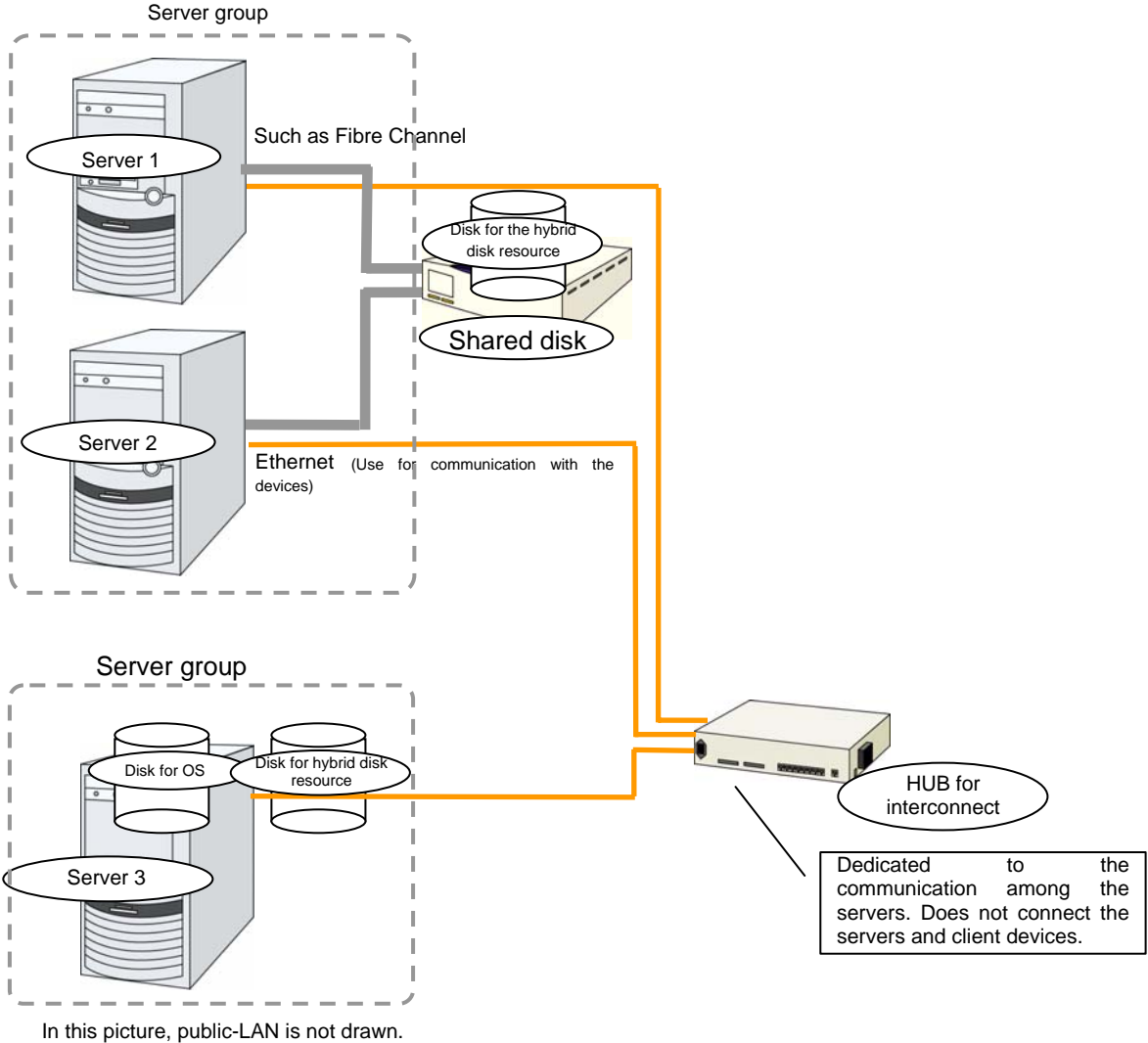

Checking system requirements for each ExpressCluster module

ExpressCluster consists of three modules: ExpressCluster Server (main module), ExpressCluster X WebManager, and ExpressCluster X Builder. Check configuration and operation requirements of each machine where these modules will be installed. The following is the basic system requirements for ExpressCluster X 2.1 for Linux:

- ◆ It is recommended to use a file system that is capable of journaling for the root file system in the operating system. File systems such as ext3, JFS, ReiserFS, XFS are available for a journaling file system supported by Linux (kernel version 2.6 or later). If a file system that is not capable of journaling is used, run an interactive command (fsck the root file system) when rebooting from server or OS stop (i.e. normal shutdown could not be done.)

Following is the system requirements for each module:

ExpressCluster Server	
Machine on which ExpressCluster Server can be installed	Server that supports one of the following operating systems.
Supported operating systems	<p>IA-32 version Red Hat Enterprise Linux AS/ES 4 (update5 or later) Red Hat Enterprise Linux 5 (update1 or later) MIRACLE LINUX V 4.0 (SP2 or later) Asianux Server 3 Novell SUSE LINUX Enterprise Server 10 (SP1 or later) Novell SUSE LINUX Enterprise Server 11 Turbolinux 11 Server VMware ESX Server 3.5 (update2 or later)</p> <p>x86-64 version Red Hat Enterprise Linux AS/ES 4 (update5 or later) Red Hat Enterprise Linux 5 (update1 or later) MIRACLE LINUX V4.0 (SP2 or later) Asianux Server 3 Novell SUSE LINUX Enterprise Server 10 (SP1 or later) Novell SUSE LINUX Enterprise Server 11 Turbolinux 11 Server Oracle Enterprise Linux 5.1</p> <p>IA64 version Red Hat Enterprise Linux AS/ES 4 (update5 or later) Red Hat Enterprise Linux 5 (update1 or later) Asianux2.0 SP1-based distribution Asianux Server 3 Novell SUSE LINUX Enterprise Server 10 (SP1 or later) Novell SUSE LINUX Enterprise Server 11 *Monitoring options do not run on IA64 OS.</p> <p>PPC64 version Asianux2.0 SP1-based distribution Asianux Server 3 Red Hat Enterprise Linux AS/ES 4 (update5 or later) Red Hat Enterprise Linux 5 (update1 or later) Novell SUSE LINUX Enterprise Server 10 (SP1 or later) Novell SUSE LINUX Enterprise Server 11 *Monitoring options do not run on ppc64 OS.</p>

ExpressCluster X Builder	
Machine on which the Builder can be installed	PC that supports one of the following operating systems.
Supported operating systems	Linux (IA-32) Microsoft Windows® XP SP2 Microsoft Windows Vista™ Microsoft Windows Server 2003 SP1 or later Microsoft Windows Server 2008 * For Microsoft Windows Vista™, only Microsoft Internet Explorer 7.0 is supported.
Supported browsers	Browsers supporting Java 2: Firefox 1.0.6 or later Konqueror 3.3.1 or later Microsoft internet Explorer 6.0 SP1 or later Microsoft Internet Explorer 7.0
Java runtime environment	Sun Microsystems Java(TM) Runtime Environment Version 5.0 Update 6 (1.5.0_06) or later * Java runtime environment is necessary to use the Builder. * For Microsoft Windows Vista™, Version 6.0 (1.6.0) or later is required.

ExpressCluster X WebManager	
Machine on which the WebManager can be installed	PC that supports one of the following operating systems.
Supported operating systems	Linux (IA-32) Microsoft Windows® XP Microsoft Windows Vista™ Microsoft Windows Server 2003 SP1 or later Microsoft Windows Server 2008 * For Microsoft Windows Vista™, only Microsoft Internet Explorer 7.0 is supported.
Supported browsers	Browsers supporting Java 2: Firefox 1.0.6 or later Konqueror 3.3.1 or later Microsoft Internet Explorer 6.0 SP1 or later Microsoft Internet Explorer 7.0
Java runtime environment	Sun Microsystems Java(TM) Runtime Environment Version 5.0 Update 6 (1.5.0_06) or later * Java runtime environment is necessary to use WebManager. * For Microsoft Windows Vista™, Version 6.0 (1.6.0) or later is required.

Related Information:

For details on supported hardware and the latest information on system requirements, refer to the *Getting Started Guide*.

Example of ExpressCluster (main module) hardware configuration

The ExpressCluster Server is a core component of ExpressCluster. Install it on each server that constitutes a cluster. ExpressCluster X WebManager is included in the ExpressCluster Server and it is automatically installed once the ExpressCluster Server is installed.

General requirements

Following is the recommended specification for the ExpressCluster Server:

- ◆ RS-232C port: 1 port (not necessary when configuring a cluster with more than 3 nodes)
- ◆ Ethernet port: 2 or more ports
- ◆ Shared disk (For disk resource and/or hybrid disk resource)
- ◆ Disk for mirroring or free partition (For mirror disk resource or hybrid disk resource)
- ◆ Floppy disk drive or USB port (For using offline Builder)
- ◆ CD-ROM drive

Related Information:

For information on system requirements for supported hardware and OS, refer to the *Getting Started Guide*.

Checking system requirements for the Builder

For information of the latest system requirements of the Builder (supported operating systems and browsers, Java runtime environment, required memory and disk size) see the *Getting Started Guide*.

Verifying system requirements for the WebManager

To monitor a cluster system that uses ExpressCluster, use WebManager, which accesses from a management PC via a Web browser. Therefore, a management PC should be able to make access to the cluster via network. The management PC can be Linux or Windows.

For information of the latest system requirements of the WebManager (supported operating systems and browsers, Java runtime environment, required memory and disk size) see the *Getting Started Guide*.

Determining a hardware configuration

Determine a hardware configuration considering an application to be duplicated on a cluster system and how a cluster system is configured. Read Chapter 2, “Configuring a cluster system” before you determine a hardware configuration.

Settings after configuring hardware

After you have determined the hardware configuration and installed the hardware, do the following:

1. Configuration of the shared disk for disk resource (Required for disk resource)
2. Configuration of the shared disk for hybrid disk resource (Required for the Replicator DR)
3. Configuration of the partition for the mirror disk resource (Required for the Replicator)
4. Configuration of the partition for hybrid disk resource (Required for the Replicator DR)
5. Adjustment of the operating system startup time (Required)
6. Verification of the network settings (Required)
7. Verification of the root file system (Required)
8. Verification of the firewall settings (Required)
9. Synchronization of the server clock (Recommended)

Shared disk settings for disk resource (Required for disk resource)

Set up the shared disk by following the steps below. For using hybrid disk resource (for Replicator DR), refer to “Shared disk settings for hybrid disk resource”

Note:

When you continue using the data on the shared disk (in the cases such as reinstalling the server), do not create partitions or a file system. If you create partitions or a file system, data on the shared disks will be deleted.

1. Allocate partitions for disk heartbeat resource.
Allocate a partition on a shared disk to be used by the disk heartbeat resource in ExpressCluster. Create a partition on one of the servers in the cluster that uses the shared disk. Use the fdisk command to set 83 (Linux) for the partition ID.

Note:

Typically, only one partition is used for heartbeat resources. However, in addition to the LUN used for heartbeat, you should create another partition used for the disk heartbeat resources in each disk as a spare dummy partition. This is because heartbeat needs to be done in other LUN when the file system gets corrupted and the device name is changed by disk error or other errors. Use the same partition number for partitions for disk heartbeat in all the LUNs.

It is recommended to use one or two disk heartbeat resources in the cluster even when multiple LUNs are used. When you set the heartbeat resource, consider how heavily the disk is loaded because it executes read/write to the disk per heartbeat interval.

A disk heartbeat partition should be 10MB (10*1024*1024 bites) or larger. It is not necessary to construct any file system for disk heartbeat partitions.

2. Allocate a partition for disk resources.
Create partitions to be used for disk resources on the shared disk. Use a server in the cluster that uses the shared disk to create the partition. Run the fdisk command to set 83 (Linux) for the partition ID.
3. Create a file system.

Configure a file system for a partition for the disk resource on a shared disk. Run the `mkfs` command on a server in the cluster that uses the shared disks as you usually do in Linux.

Note:

It is not necessary to construct the file system for a partition for the disk heartbeat resource. The ExpressCluster controls the file systems on shared disks. Do not enter the file systems on the shared disks into `/etc/fstab` in the operating system.

- ◆ In principle, the file system used on shared disk does not depend on others. However, an error may occur depending on `fsck` on file system.
- ◆ It is recommended to use a file system that is capable of journaling to avoid system failure.
- ◆ Following is the currently supported file systems in IA-32 and x86-64 machines:

`ext3`

`xfs`

`reiserfs`

`jfs`

`vxfv`

Note:

Distributions and kernels where `vxfv` can be used depend on the support status of `vxfv`.

- ◆ Following is the currently supported file system in IA-64 and PPC64 machines:

`ext3`

4. Create a mount point.

Create a directory to mount the partition for disk resources.

Create this directory on all servers in the cluster that use disk resources.

Shared disk settings for hybrid disk resource (Required for Replicator DR)

Configure the shared disk for hybrid disk resource by following the steps below. For information on settings for general disk resource, see “Shared disk settings for disk resource”

To use a disk other than a shared disk (such as internal disk of the server or a non-shared external disk) as a hybrid disk resource, see “Partition settings for hybrid disk resource”

Note:

When you continue using the data on the shared disk (in the cases such as reinstalling the server), do not create partitions or a file system. If you create partitions or a file system, data on the shared disks will be deleted.

1. Allocate the cluster partitions.

Allocate a partition to be used by the mirror driver. The mirror driver uses this partition to monitor the status of hybrid disk.

Create a partition from one server in the cluster that uses shared disk. Use the fdisk command to set 83 (Linux) for the partition ID.

Note:

A cluster partition should be 10 MB (10*1024*1024 byte) or larger. (The size will be actually larger than 10 MB even if you specify exactly 10 MB because of the disk geometry difference. This will cause no problem.) You do not need to create a file system on this partition.

2. Initialize the cluster partition. (Required only when you continue using disk used as ExpressCluster mirror disk or hybrid disk.)

◆ Initialization is required since the old data on the cluster partition remains even if allocation of the partition is performed.

◆ If you continue to use a disk that was once used as an ExpressCluster mirror disk or hybrid disk, make sure to initialize it.

◆ Run the following command from one server in the cluster that uses shared disk:

```
dd if=/dev/zero of=[Name of the partition device to be used as cluster partition]
```

Note:

Running the dd command initializes the specified data partition. Before you run the dd command make sure to check the partition device name.

The following message is displayed when you run the dd command. This is not an error.

```
dd: writing to [Partition_device_name_used_as_a_cluster_partition]: No space left on device
```

3. Allocate the partition for hybrid disk resource

Allocate a partition to be used by the hybrid disk resource on the shared disk. Create the partition from one server in the cluster that uses shared disk.

Use the fdisk command to set 83 (Linux) for the partition ID.

4. Allocate the partitions for disk heartbeat resource.

Allocate partitions on the shared disk exclusively used by ExpressCluster. Create the partitions from one of the servers in the cluster that uses the shared disk. Use the fdisk command to set 83 (Linux) for the partition ID.

Note:

Typically, only one partition is used for heartbeat resources. However, in addition to the LUN used for heartbeat, you should create another partition used for the disk heartbeat resources in each disk as a spare dummy partition. This is because heartbeat needs to be done in other LUN when the file system gets corrupted and the device name is changed by disk error or other errors. Use the same partition numbers for partitions for disk heartbeat in all the LUNs.

It is recommended to use one or two disk heartbeat resources in the cluster even when multiple LUNs are used. When you set heartbeat resources, consider how heavily the disk is loaded because each heartbeat resource executes read/write to the disk per heartbeat interval. A disk heartbeat partition should be 10MB (10*1024*1024 bites) or larger. It is not necessary to configure a file system for disk heartbeat partitions.

5. Create a mount point.

Create a directory to mount the partition for hybrid disk resources.

Create this directory on servers that use hybrid disk resource and connecting to the shared disk.

Partition settings for mirror disk resource (Required for the Replicator)

Set up partitions for mirror disk resource by following the steps below. When using hybrid disk resource (when Replicator DR is used) refer to “Partition settings for hybrid disk resource.”

Note:

When you continue using the data on a shared disk (for example, when you cluster a single server), do not create partitions or a file system. If you create partitions or a file system, data on the shared disks will be deleted.

1. Allocate partitions for mirror disk resource.

Allocate a partition to be used by the mirror driver. The mirror driver uses this partition to monitor the status of mirror disk resource. Create a partition in every server in the cluster that uses mirror disk resource. Use the fdisk command to set 83 (Linux) for the partition ID.

Note:

A partition for mirror disk resource should be 10 MB (10*1024*1024 byte) or larger. (The size will be actually larger than 10 MB even if you specify exactly 10 MB because of the disk geometry difference. This will cause no problem.) You do not need to create a file system on this partition.

2. Initialize the mirror disks. (Required only when you continue using mirror disks that were used as ExpressCluster mirror disks)

- ◆ Initialization is required since the old data on partitions survive even if allocation of partitions is performed.

- ◆ If you continue to use a disk that was once used as an ExpressCluster mirror disk, make sure to initialize it.

- ◆ Run the following command:

```
dd if=/dev/zero of=[Partition device name to be used as cluster partition]
```

Note:

Running the dd command initializes the specified data partition. Before you run the dd command make sure to check the partition device name.

The following message is displayed when you run the dd command. This is not an error.
dd: writing to [Partition_device_name_used_as_a_cluster_partition]: No space left on device

3. Allocate partitions for mirror disk resource

Create partitions to be used for mirror disk resources. Create a partition in every server in the cluster that use mirror resources. Run the fdisk command to set 83 (Linux) for the partition ID.

4. It is not necessary to create a file system on partition for mirror disk resources.
 - ◆ When **Execute initial mkfs** is selected in creating the cluster configuration data with the Builder, ExpressCluster automatically creates a file system. If **Execute initial mkfs** is not selected, file system will not be created.
 - ◆ A file system used on a shared disk does not depend on other file systems. However, an error may occur depending on fsck on file system.
 - ◆ It is recommended to use a file system that is capable of journaling to avoid system failure.
 - ◆ Following is the currently supported file systems in IA-32 and x86-64 machines:
 - ext3
 - xf
 - reiserfs
 - jfs

Note:

Do not select **Execute initial mkfs** when you continue using the data on cluster partition. The ExpressCluster controls the file systems on mirror resource. Do not enter the mirror resource or partition for mirror resource into `/etc/fstab` in the operating system. Distributions and kernels where vxfs can be used depend on the support status of vxfs.

5. Create a mount point.

Create a directory to the mount partition for mirror disk resources.
Create this directory on all servers in the cluster that use disk resources.

Partition settings for hybrid disk resource (when using Replicator DR)

Follow the steps below to configure the partitions when a non-shared disk (such as internal disk of the server or a non-shared external disk) is used as a hybrid disk resource.

For settings in a general mirror configuration (when Replicator is used), see “Partition settings for mirror disk resource.”

When a shared disk is used as hybrid disk resource, see “Shared disk settings for hybrid disk resource.”

Note:

When you continue using an existing partition (in the cases such as clustering a single server) or reinstalling server, do not allocate a partition for mirror resources. If you create the partition for mirror resources, data on the existing partition will be deleted.

1. Allocate a cluster partition.

Allocate a partition to be used by the mirror driver. The mirror driver uses this partition to monitor the status of hybrid disk.

Use the fdisk command to set 83 (Linux) for the partition ID.

Note:

A cluster partition should be 10 MB (10*1024*1024 byte) or larger. (The size will be actually larger than 10 MB even if you specify exactly 10 MB because of the disk geometry difference. This will cause no problem.) You do not need to create a file system on this partition.

2. Initialize the cluster partition. (Required only when you continue using a disk that was used as ExpressCluster mirror disk or hybrid disk.)

◆ Initialization is required since the old data on the cluster partition remains even if allocation of partitions is performed.

◆ If you continue to use a disk that was once used as an ExpressCluster mirror disk or hybrid disk, make sure to initialize it.

◆ Run the following command:

```
dd if=/dev/zero of=[The name of the partition device to be used as cluster partition]
```

Note:

Running the dd command initializes the specified data partition. Before you run the dd command make sure to check the partition device name.

The following message is displayed when you run the dd command. This is not an error.

```
dd: writing to [Partition_device_name_used_as_a_cluster_partition]: No space left on device
```

3. Allocate a partition for hybrid disk resource

Allocate a partition to be used by the hybrid disk resource.

Use the fdisk command to set 83 (Linux) for the partition ID.

4. Create a mount point.

Create a directory to mount the partition for hybrid disk resources.

Adjustment of the operating system startup time (Required)

It is necessary to configure the time from power-on of each node in the cluster to the server operating system startup to be longer than the following:

- ◆ The time from power-on of the shared disk to the point they become available.
- ◆ Heartbeat timeout time (90 seconds by default in the Builder.)

Adjustment of the startup time is necessary due to the following reasons:

- ◆ Activating disk resources fails if the cluster system is started by powering on the shared disk and servers.
- ◆ A failover fails if a server, with data you want to fail over by rebooting the server, reboots within the heartbeat timeout. This is because a remote server assumes heartbeat is continued.

Consider the times durations above and adjust the operating system startup time by following the procedure below.

Note:

How you configure the time is determined by what is used as an operating system loader, LILO or GRUB.

When GRUB is used for the operating system loader

1. Edit /boot/grub/menu.lst.

Specify the time-out `<Startup_time (in seconds)>` option. In the following example, change only the underlined part.

```
---(Example: Startup time: 90 seconds)---
default 0
timeout 90

title linux
    kernel (hd0,1)/boot/vmlinuz
    root=/dev/sda2 vga=785
    initrd (hd0,1)/boot/initrd

title floppy
    root (fd0)
    chainloader +1
```

When LILO is used for the operating system loader

1. Edit /etc/lilo.conf.

Specify the prompt option and `timeout=<Startup_time_(in 1/10 seconds)>` option, or specify the `delay=<Startup_time (in 1/10 seconds)>` option without specifying the prompt option. In the following example, change only the underlined part.

```
---(Example 1: Output prompt. Startup time: 90 seconds)---
boot=/dev/sda
map=/boot/map
install=/boot/boot.b
prompt
linear
timeout=900
image=/boot/vmlinuz
```

```
label=linux
root=/dev/sda1
initrd=/boot/initrd.img
read-only

---(Example 2: Not output prompt. Startup time: 90 seconds)---
boot=/dev/sda
map=/boot/map
install=/boot/boot.b
#prompt
linear
delay=900
image=/boot/vmlinuz
        label=linux
        root=/dev/sda1
        initrd=/boot/initrd.img
        read-only
```

2. Run the `/sbin/lilo` command to make the changes of the setting effective.

Note:

When you are using an operating system loader other than LILO or GRUB is used, see the setup guide of the operating system loader.

Verification of the network settings (Required)

On all servers in the cluster, verify the status of the following networks using the `ifconfig` or `ping` command. Verify if network devices (`eth0`, `eth1`, `eth2`, etc) are assigned to appropriate roles, such as public LAN and interconnect-dedicated LAN.

- ◆ Public LAN (used for communication with all the other machines)
- ◆ LAN dedicated to interconnect (used for communication between ExpressCluster Servers)
- ◆ Host name

Note:

It is not necessary to specify the IP addresses of floating IP resources or virtual IP resources used in the cluster in the operating system.

Verification of the root file system (Required)

It is recommended to use a file system which is capable of journaling for the root file system in the operating system. File systems such as `ext3`, `JFS`, `ReiserFS`, `XFS` are available for a journaling file system supported by Linux (version 2.6 or later).

Important:

If a file system that is not capable of journaling is used, you must run an interactive command (`fsck` the root file system) when rebooting from server or OS stop (for example, normal shutdown could not be done.) This is not limited to cluster system and the same is true for a single server.

Verification of the firewall settings (Required)

ExpressCluster uses several port numbers. Change the firewall settings so that ExpressCluster can use some port numbers.

The following is the list of port numbers used in ExpressCluster:

Server to Server (Loopback in Server)					
					Used for
Server	Automatic allocation	-	Server	29001/TC P	Internal communication
Server	Automatic allocation	-	Server	29002/TC P	Data transfer
Server	Automatic allocation	-	Server	29002/UD P	Heartbeat
Server	Automatic allocation	-	Server	29003/UD P	Alert synchronization
Server	Automatic allocation	-	Server	29004/TC P	Communication between mirror agents
Server	Automatic allocation	-	Server	29006/UD P	Heartbeat (kernel mode)
Server	Automatic allocation	-	Server	XXXX/TC P	Mirror disk resource data synchronization
Server	Automatic allocation	-	Server	XXXX/TC P	Communication between mirror drivers
Server	Automatic allocation	-	Server	XXXX/TC P	Communication between mirror drivers Duplication check of FIP/VIP resource Mirror agent
Server	Automatic allocation	-	Server	icmp	keepalive between mirror drivers

WebManager to Server					
					Used for
WebManager	Automatic allocation	-	Server	29003/TC P	http communication

Server connected to the Integrated WebManager to target server					
					Used for
Server connected to the Integrated WebManager	Automatic allocation	-	Server	29003/TC P	http communication

Others					
		-			Used for
Server	Automatic allocation	-	Network warning light	514/TCP	Network warning light control
Server	Automatic allocation	-	BMC Management LAN of the server	623/UDP	BMC control (Forced stop/chassis identify)
Server	Automatic allocation	-	Monitoring target	icmp	IP monitor
Server	Automatic allocation	-	NFS Server	icmp	Monitoring if NFS server of NAS resource is active
Server	Automatic allocation	-	Monitoring target	icmp	Monitoring target of PING method of network partition resolution resource

1. In automatic allocation, a port number not being used at a given time is allocated.
2. This is a port number used on a mirror disk/hybrid disk resource basis and is set when creating mirror disk resource or hybrid disk. A port number 29051 is set by default. When you add a mirror disk resource or hybrid disk, this value is automatically incremented by 1. To change the value, click **Detail** tab of **Mirror Disk Resource Properties** or **Hybrid Disk Resource Properties** in the Builder. For more information, refer to Chapter 5, “Group resource details” in *Reference Guide*.
3. This is a port number used on a mirror disk resource/hybrid disk basis and is set when creating mirror disk resource or hybrid disk. A port number 29031 is set by default. When you add a mirror disk resource or a hybrid disk, this value is automatically incremented by 1. To change the value, click **Detail** tab of **Mirror Disk Resource Properties** or **Hybrid Disk Resource Properties** in the Builder. For more information, refer to Chapter 5, “Group resource details” in *Reference Guide*.
4. This is a port number used on a mirror disk resource/hybrid disk basis and is set when creating mirror disk resource or hybrid disk. A port number 29071 is set by default. When you add a mirror disk resource/hybrid disk, this value is automatically incremented by 1. To change the value, click **Detail** tab of **Mirror Disk Resource Properties** or **Hybrid Disk Resource Properties** in the Builder. For more information, refer to Chapter 5, “Group resource details” in *Reference Guide*.
5. In the **Port Number** (log) tab in **Cluster Properties**, select **UDP** for log communication, and use the port number configured at **Port Number**. The default log communication method, **UNIX Domain**, does not use a communication port.

Server clock synchronization (Required)

It is recommended to regularly synchronize the clocks of all the servers in the cluster. Make the settings that synchronize server clocks through protocol such as ntp on a daily basis.

Note:

If the clock in each server is not synchronized, it may take time to analyze the problem when an error occurs.

Chapter 2 Configuring a cluster system

This chapter provides information on applications to be duplicated, cluster topology, and explanation on cluster configuration data that are required to configure a cluster system.

This chapter covers:

- Configuring a cluster system 46
- Determining a cluster topology..... 47
- Determining applications to be duplicated 50
- Planning a cluster configuration 54
- Understanding group resources 55
- Understanding monitor resources 56
- Understanding heartbeat resources 58
- Understanding network partition resolution resources 59

Configuring a cluster system

This chapter provides information necessary to configure a cluster system, including the following topics:

1. Determining a cluster system topology
2. Determining applications to be duplicated
3. Creating the cluster configuration data

In this guide, explanations are given using a 2-node and uni-directional standby cluster environment as an example.

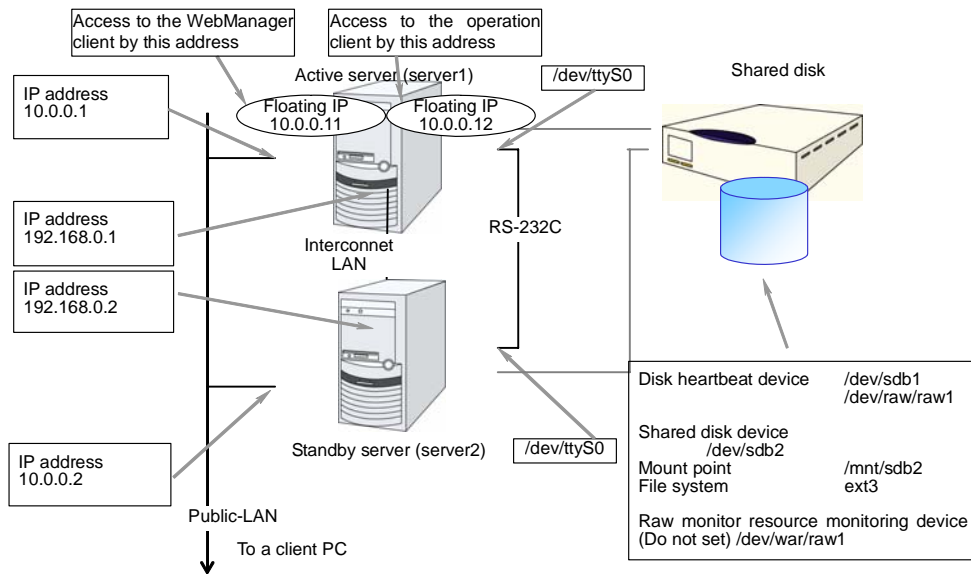

Determining a cluster topology

ExpressCluster supports multiple cluster topologies. There are uni-directional standby cluster system that considers one server as an active server and other as standby server, and multi-directional standby cluster system in which both servers act as active and standby servers for different operations.

- ◆ **Uni-directional standby cluster system**

In this operation, only one application runs on an entire cluster system. There is no performance deterioration even when a failover occurs. However, resources in a standby server will be wasted.

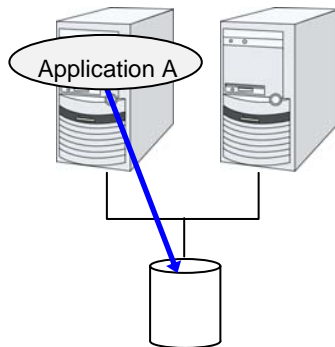

- ◆ **The same applications – multi-directional standby cluster system**

In this operation, the same applications run simultaneously on a cluster system. Applications used in this system must support multi-directional standby operations.

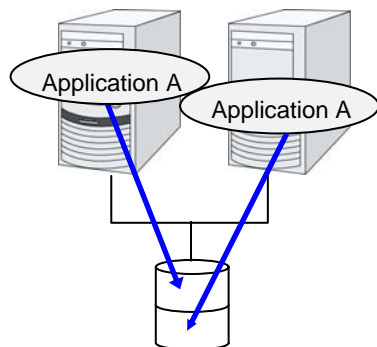

- ◆ **Different applications multi-directional standby cluster system**

In this operation, different applications run on different servers and standby each other. Resources will not be wasted during normal operation; however, two applications run on one server after failing over and system performance deteriorates.

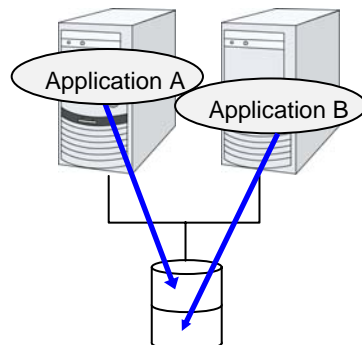

Failover in uni-directional standby cluster

On a uni-directional standby cluster system, the number of groups for an operation service is limited to one as described in the diagrams below:

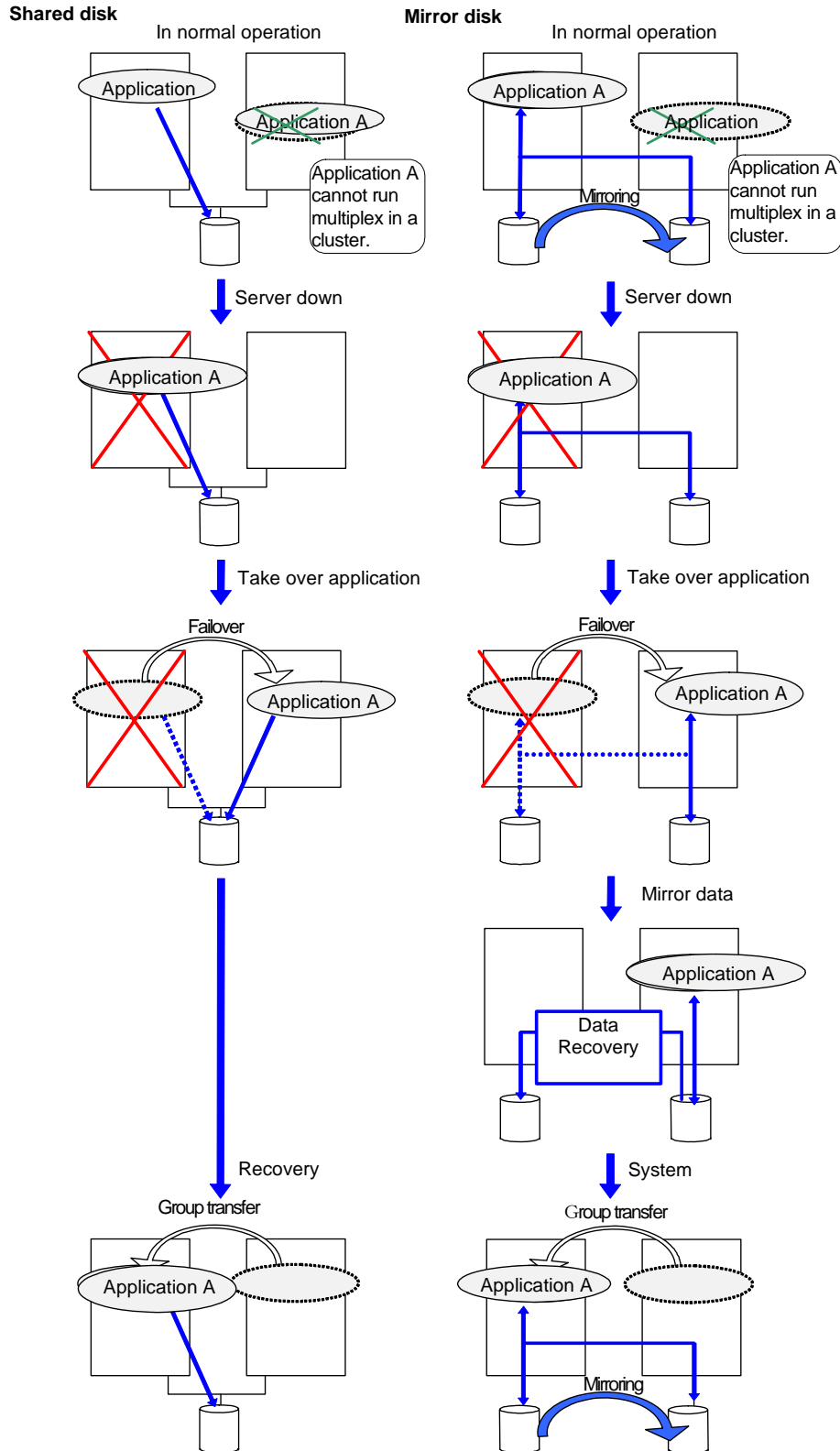

Failover in multi-directional standby cluster

On a multi-directional standby cluster system, an application can simultaneously run on multiple servers. However, an active server gets heavily loaded when a failover occurs as described in the diagram below:

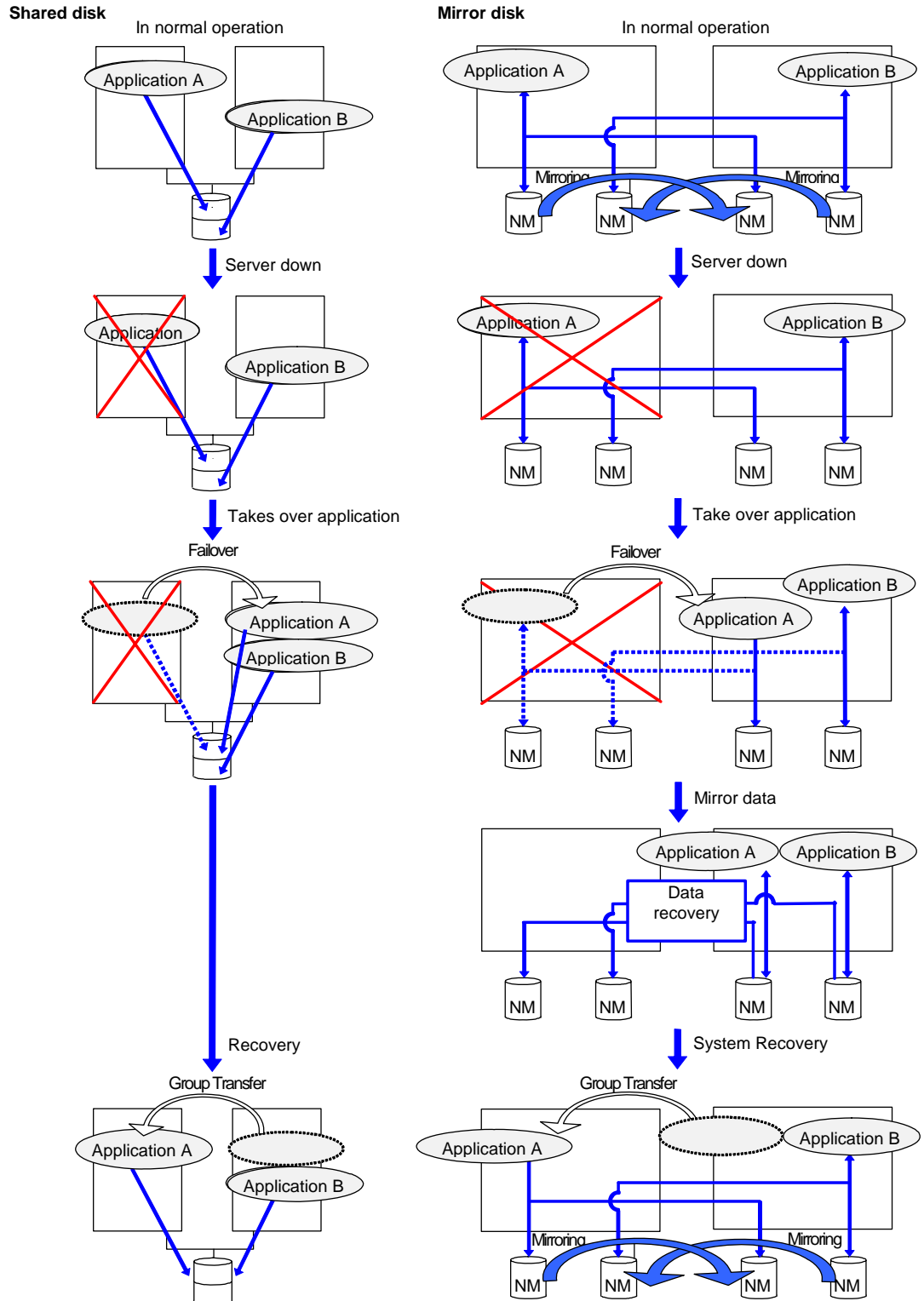

Determining applications to be duplicated

When you determine applications to be duplicated, study candidate applications considering the points described below to see whether they should be clustered in your ExpressCluster cluster system.

Configuration relevant to the notes

What you need to consider differs depending on which standby cluster system is selected for an application. Following is the notes for each cluster system. The numbers correspond to the numbers of notes (1 through 5) described above:

- ◆ Note for uni-directional standby [Active-Standby]: 1, 2, 3, and 5
- ◆ Note for multi-directional standby [Active-Active]: 1, 2, 3, 4, and 5
- ◆ Note for co-existing behaviors: 5
(Applications co-exist and run. The cluster system does not fail over the applications.)

Server applications

Note 1: Data recovery after an error

If an application was updating a file when an error has occurred, the file update may not be completed when the standby server accesses to that file after the failover.

The same problem can happen on a non-clustered server (single server) if it goes down and then is rebooted. In principle, applications should be ready to handle this kind of errors. A cluster system should allow recovery from this kind of errors without human interventions (from a script).

ExpressCluster executes fsck if the file system on a shared disk or mirror disk requires fsck.

Note 2: Application termination

When ExpressCluster stops or transfers (performs online failback of) a group for application, it unmounts the file system used by the application group. Therefore, you have to issue an exit command for applications so that they stop accessing files on a shared disk or mirror disk.

Typically, you give an exit command to applications in their stop scripts; however, you have to pay attention if an exit command completes asynchronously with termination of the application.

Note 3: Location to store the data

ExpressCluster can pass the following types of data between servers:

- ◆ Data on shared disk or mirror disks

Application data should be divided into the data to be shared among servers and the data specific to the server, and these two types of data should be saved separately. .

Data type	Example	Where to store
Data to be shared among servers	User data, etc.	On shared disk or mirror disks
Data specific to a server	Programs, configuration data	On server's local disks

Note 4: Multiple application service groups

For multi-directional standby operation, you have to assume (in case of degeneration due to a failure) that multiple application groups are run by the same application on a server.

Applications should have capabilities to take over the passed resources by one of the following methods described in the diagram below. A single server is responsible for running multiple application groups. The same is true for mirror disks:

- ◆ **Starting up multiple instances**
This method invokes a new process. More than one application should co-exist and run.

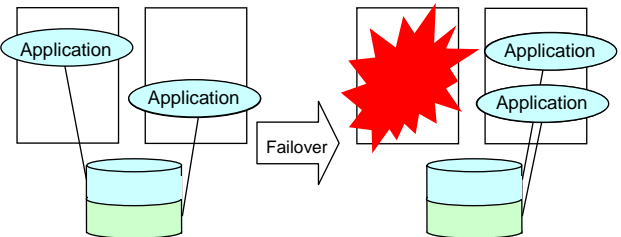

- ◆ **Restarting the application**
This method stops the application which was originally running. Added resources become available by restarting it.

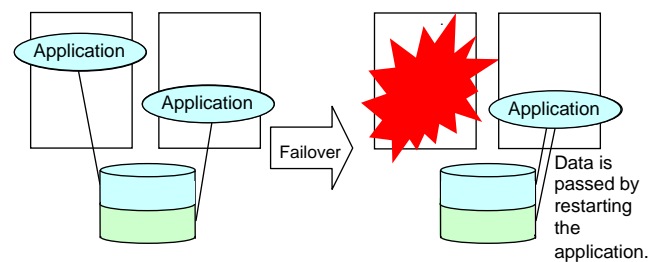

- ◆ **Adding dynamically**
This method adds resources in running applications automatically or by instructions from script.

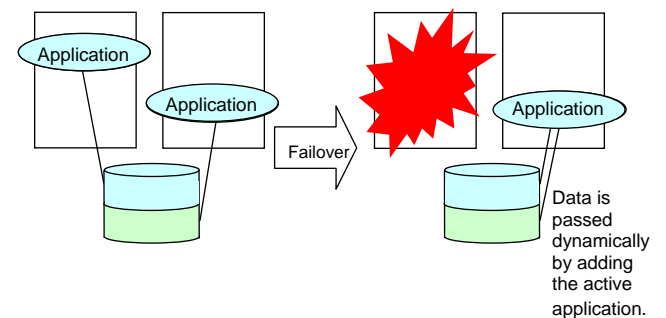

Note 5: Mutual interference and compatibility with applications

Sometimes mutual interference between applications and ExpressCluster functions or the operating system functions required to use ExpressCluster functions prevents applications or ExpressCluster from working properly.

- ◆ Access control of switching partitions and mirror partitions
Inactive disk resources are not writable.
Inactive mirror disk resources or hybrid disk resources are inaccessible.
Applications cannot access an inactive disk, mirror disk resource or hybrid disk resources (i.e. disk to which applications have no access right).

Generally, you can assume when an application that is started up by cluster script is started, the disk resource, mirror disk resource or hybrid disk resource to which it should access is already accessible.
- ◆ Multi-home environment and transfer of IP addresses
In a cluster system, a server usually has multiple IP addresses, and an IP address (such as floating IP address) moves between servers.
- ◆ Access to shared disks or mirror disks from applications
The stopping of application groups is not notified to co-existing applications. Therefore, if such an application is accessing a disk resource, mirror disk resource, or hybrid disk resource used by an application group at the time when the application group stops, unmount will fail.

Some applications like those responsible for system monitoring service periodically access all disk partitions. To use such applications in your cluster environment, they need a function that allows you to specify monitoring partitions.

Solution to the problems relevant to the notes

Problems	Solution	Note to refer
When an error occurs while updating a data file, the application does not work properly on the standby server.	Modify the program	Note 1: Data recovery after an error
The application keeps accessing a disk or file system for a certain period of time even after it is stopped.	Execute the sleep command during stop script execution.	Note 2: Application termination
The same application cannot be started more than once on one server.	In multi-directional operation, reboot the application at failover and pass the shared data.	Note 3: Location to store the data

How to determine a cluster topology

Carefully read this chapter and determine the cluster topology that suits your needs:

- ◆ When to start which application
- ◆ Actions that are required at startup and failover
- ◆ Data to be placed in disk resources, mirror disk resources or hybrid disk resources.

Planning a cluster configuration

A group is a set of resources required to perform an independent operation service in a cluster system. Failover takes place by the unit of group. A group has its group name, group resources, and attributes.

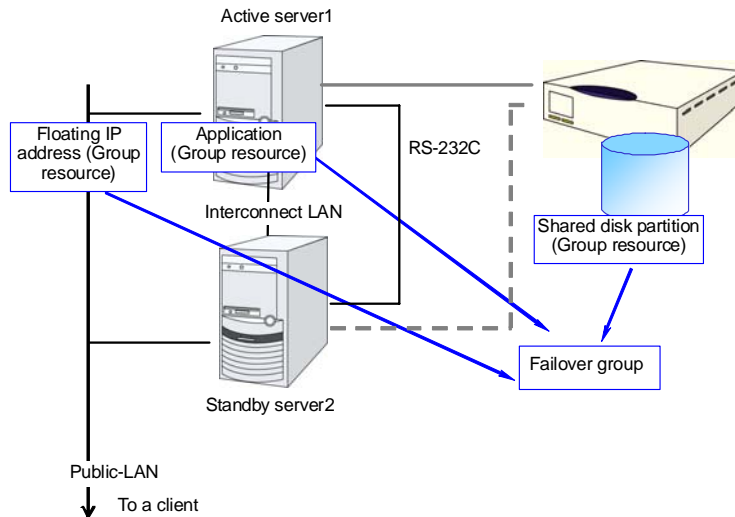

Resources in each group are handled by the unit of the group. If a failover occurs in group1 that has disk resource1 and floating IP address1, a failover of disk resource1 and a failover of floating IP address1 are concurrent (failover of disk resource 1 never takes place without that of floating IP address 1). Likewise, disk resources1 is never contained in other groups, such as group2.

Understanding group resources

For a failover to occur in a cluster system, a group that works as a unit of failover must be created. A group consists of group resources. In order to create an optimal cluster, you must understand what group resources to be added to the group you create, and have a clear vision of your operation.

Related Information:

For details on each resource, refer to the *Reference Guide*.

Following is the currently supported group resources:

Group Resource Name	Abbreviation
EXEC resource	exec
Disk resource	disk
Floating IP resource	fip
Virtual IP resource	vip
Mirror disk resource	md
Hybrid disk resource	hd
Raw resource	raw
VxVM disk group resource	vx dg
VxVM volume resource	vx vol
NAS resource	nas

Understanding monitor resources

Monitor resources monitor specified targets. If an error is detected in a target, a monitor resource restarts and/or fails over the group resources.

Following is the currently supported monitor resource:

Monitor Resource Name	Abbreviation
Disk monitor resource	diskw
Raw monitor resource	raww
IP monitor resource	ipw
NIC Link Up/Down monitor resource	miiw
Mirror disk connect monitor resource	mdnw
Mirror disk monitor resource	Mdw
Hybrid disk connect monitor resource	Hdnw
Hybrid disk monitor resource	hdw
PID monitor resource	pidw
User space monitor resource	userw
Custom monitor resource	genw
VxVM daemon monitor resource	vxdw
VxVM volume monitor resource	vxvolw
Multi-target monitor resource	mtw
Virtual IP monitor resource	vipw
ARP monitor resource	arpw
DB2 monitor resource	db2w
FTP monitor resource	ftpw
HTTP monitor resource	httpw
IMAP4 monitor resource	imap4
MySQL monitor resource	mysqlw
NFS monitor resource	nfsw
Oracle monitor resource	oraclew
OracleAS monitor resource	oracleasw
POP3 monitor resource	pop3w
PostgreSQL monitor resource	psqlw
Samba monitor resource	sambaw
SMTP monitor resource	smtpw
Sybase monitor resource	sybasew
Tuxedo monitor resource	tuxw
Websphere monitor resource	wasw
Weblogic monitor resource	wlsw
WebOTX monitor resource	otwx

There are two types of timing for monitoring monitor resources: always monitor and monitor when active.

- ◆ Always monitor (From cluster startup to cluster stop)
 - Disk monitor resources
 - IP monitor resources
 - User space monitor resources
 - Mirror disk monitor resources
 - Mirror disk connect monitor resources
 - Hybrid disk monitor resources
 - Hybrid disk connect monitor resources
 - Raw monitor resources
 - VxVM daemon monitor resources
 - NIC Link Up/Down monitor resources
 - Multi-target monitor resources
 - Custom monitor resources
- ◆ Monitor when active (From group activation to group deactivation)
 - PID monitor resources
 - VxVM volume monitor resources
 - Virtual IP monitor resource
 - ARP monitor resource
 - DB2 monitor resource
 - FTP monitor resource
 - HTTP monitor resource
 - IMAP4 monitor resource
 - MySQL monitor resource
 - NFS monitor resource
 - Oracle monitor resource
 - OracleAS monitor resource
 - POP3 monitor resource
 - PostgreSQL monitor resource
 - Samba monitor resource
 - SMTP monitor resource
 - Sybase monitor resource
 - Tuxedo monitor resource
 - Websphere monitor resource
 - Weblogic monitor resource
 - WebOTX monitor resource

Understanding heartbeat resources

Servers in a cluster system monitor if other servers in the cluster are active. For this, heartbeat resources are used. Following is the heartbeat device types:

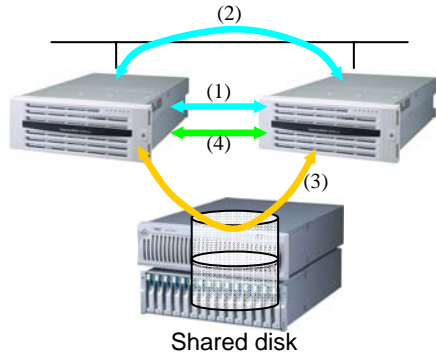

- (1) LAN heartbeat resource dedicated to interconnect
- (1) LAN heartbeat resource dedicated to interconnect (kernel mode)
- (2) Public LAN heartbeat
- (2) Public LAN heartbeat (kernel mode)
- (3) Disk heartbeat
- (4) COM heartbeat

Heartbeat Resource Name	Abbreviation	Functional Overview
LAN heartbeat resource (1)(2)	lanhb	Uses a LAN to monitor if servers are active. Used for communication within the cluster as well.
Kernel mode LAN heartbeat resource (1)(2)	lankhb	A kernel mode module uses a LAN to monitor if servers are active. Used for communication within the cluster as well.
Disk heartbeat resource (3)	diskhb	Uses a dedicated partition in the shared disk to monitor if servers are active.
COM heartbeat resource (4)	comhb	Uses a COM cable to connect two servers to monitor if servers are active.

- ◆ At least one LAN heartbeat resource needs to be set. Setting up more than two LAN heartbeat resources is recommended. It is also recommended to set both LAN heartbeat resource and kernel mode LAN heartbeat resource.
- ◆ Follow the specifications below to set the interface for disk heartbeat resource and COM heartbeat resource:

When a shared disk is used:	Up to two servers: In principle, COM interface and disk interface More than three servers: Disk interface
When a shared disk is not used:	Up to two servers: COM interface

Understanding network partition resolution resources

Network partitioning or the “Split Brain Syndrome” refers to the status where all communication channels have problems and the network between servers is partitioned.

In a cluster system that is not equipped with solutions for the “Split Brain Syndrome,” a failure on a communication channel cannot be distinguished from an error on a server. This can cause data corruption brought by access from multiple servers to the same resource. ExpressCluster, on the other hand, distinguishes a failure on a server from the “Split Brain Syndrome” when the heartbeat from a server is lost. If the lack of heartbeat is determined to be caused by the server failure, the system performs a failover by activating each resource and rebooting applications on a server running normally. When the lack of heartbeat is determined to be caused by the “Brain Split Syndrome,” emergency shutdown is executed because protecting data has higher priority over continuity of the operation. Network partitions can be resolved by the following methods:

Ping method

- ◆ A device that is always active to receive and respond to the ping command (hereafter described as ping device) is required.
- ◆ More than one ping device can be specified.
- ◆ When the heartbeat from the other server is lost, but the ping device is responding to the ping command, it is determined that the server without heartbeat has failed and a failover takes place. If there is no response to the ping command, the local server is isolated from the network due to the Split Brain syndrome, and emergency shutdown takes place. This will allow a server that can communicate with clients to continue operation even if the Split Brain syndrome occurs.
- ◆ When the status where no response returns from the ping command continues before the heartbeat is lost, which is caused by a failure in the ping device, the network partitions cannot be resolved. If the heartbeat is lost in this status, a failover takes place in all servers. Because of this, using this method in a cluster with a shared disk can cause data corruption due to access to a resource from multiple servers.

Not solving the network partition

- ◆ If a failure occurs on all the network channels between servers in a cluster, all the servers fail over.

The following are the recommended methods to resolve the network partition:

- The ping method is recommended for a remote cluster.

Method to resolve a network partition	Number of nodes	Required hardware	Circumstance where failover cannot be performed	When all network channels are disconnected	Circumstance where both servers fail over	Time required to resolve network partition
Ping	No limit	Device to receive the ping command and return a response	None	Server that responds to the ping command survives	All networks are disconnected after the ping command timeouts the specified times consecutively.	0
None	No limit	None	None	All servers fail over	All the networks are disconnected	0

Section II Installing and configuring ExpressCluster X

This section describes procedures to install ExpressCluster. Configure a cluster system by installing ExpressCluster to server machines and using the cluster configuration data that you have created in Section I. After that, run the operation tests and verify if the system operates successfully.

- Chapter 3 Installing ExpressCluster
- Chapter 4 Registering the license
- Chapter 5 Creating the cluster configuration data using the Builder
- Chapter 6 Verifying a cluster system
- Chapter 7 Modifying the cluster configuration data

Chapter 3 Installing ExpressCluster

This chapter provides instructions for installing ExpressCluster. For ExpressCluster installation, install ExpressCluster Server which is the core component of ExpressCluster. A management tool, ExpressCluster X WebManager, will be automatically installed when accessing the ExpressCluster Server from the browser on the management PC. It is not necessary to install the ExpressCluster X WebManager and Builder separately.

This chapter covers:

- Steps from Installing ExpressCluster to creating a cluster..... 64
- Setting up the ExpressCluster Server..... 65

Steps from Installing ExpressCluster to creating a cluster

The following describes the steps of installing ExpressCluster, registering the license, creating a cluster and verifying the installation.

Before proceeding to the steps, make sure to read Section I and check system requirements and the configuration of a cluster.

1. Set up the ExpressCluster Server

Install the ExpressCluster Server, which is the core ExpressCluster module, to each server that constitutes a cluster. (See Chapter 3, “Installing ExpressCluster.”)

Reboot the server

2. Register the license

Register the license by running the `clplnsc` command. (See Chapter 4, “Registering the license.”)

Reboot the server

3. Creating the cluster configuration data using the Builder

Create the cluster configuration data using the Builder. (See Chapter 5, “Creating the cluster configuration data using the Builder.”)

4. Create a cluster

Create a cluster using the configuration data created with the Builder. (See Chapter 5, “Creating the cluster configuration data using the Builder.”)

5. Verify the cluster status using the WebManager

Verify the status of a cluster that you have created using the WebManager. (See Chapter 6, “Verifying a cluster system.”)

Setting up the ExpressCluster Server

The ExpressCluster Server, which is the core component of ExpressCluster, consists of the following system services. It is set up by installing the ExpressCluster Server RPM.

System Service Name	Description
clusterpro	ExpressCluster daemon: A service of ExpressCluster itself.
clusterpro_evt	ExpressCluster event: A service to control syslog and logs being output from ExpressCluster.
clusterpro_trn	ExpressCluster data transfer: A service to control license synchronization and configuration data transfer in a cluster.
clusterpro_md	ExpressCluster mirror agent A service to control mirror disk resource, hybrid disk resource and mirror driver of ExpressCluster.
clusterpro_alertsync	ExpressCluster alert synchronization: A service to synchronize alerts among servers in the cluster.
clusterpro_webmgr	ExpressCluster WebManager: A WebManager service.

Installing the ExpressCluster RPM

Install the ExpressCluster Server RPM on all servers that constitute the cluster by following the procedures below.

Note:

Log in as root user when installing the ExpressCluster Server RPM.

1. Mount the installation CD-ROM.
2. Run the rpm command to install the package file.
The installation RPM varies depending on the products.

Navigate to the folder, /Linux/2.1/en/server, in the CD-ROM and run the following:

```
rpm -i expresscls-[version].[architecture].rpm
```

There are I686, x86-64, IA-64, and PPC64 for architecture. Select one of them according to the environment where the server RPM is installed. Verify the architecture by running the arch command.

The installation starts.

Note:

ExpressCluster will be installed in the following directory. You will not be able to uninstall the ExpressCluster if you change this directory.

Installation Directory: /opt/nec/clusterpro

3. When the installation is completed, unmount the installation CD-ROM.

4. Remove the installation CD-ROM.
When you do not use the ExpressCluster Builder (offline version), proceed to a license registration procedure.

Installing the Builder on a Linux machine (Offline version)

It is not necessary to install the ExpressCluster X Builder (offline version) to the server where configure a cluster. Install it only when modifying the cluster configuration data on a PC excluding the servers that configure a cluster.

Follow the procedures below to install the ExpressCluster X Builder (offline version).

Note:

Log in as root user when installing ExpressCluster Builder on Linux machine.

1. Mount the installation CD-ROM.
2. Navigate to the folder, /Linux/2.1/en/builder, in the CD-ROM and run the following:

```
rpm -i expressclsbuilder-[version #] - [release #].linux.i686.rpm
```

The installation starts.

Note:

- The Builder will be installed in the following location. You will not be able to uninstall the Builder if you change this directory.
Installation Directory: **/opt/nec/clpbuilder**
 - The version number and release number that you need to specify is rpm version number stated in ExpressCluster X Installation CD. When there are multiple versions of rpm, refer to “Supported ExpressCluster versions” in Chapter 3, “Installation requirements for ExpressCluster” in the *Getting Started Guide* and select an appropriate version and release number.
-

3. When the installation is completed, unmount the CD-ROM.

Installing the Builder on a Windows machine (Offline version)

When you install the ExpressCluster X Builder on Windows machine, install it in a directory where you can access (read/write) by the security right granted to you.

1. Set the Installation CD-ROM in the CD-ROM drive.
2. Navigate to the \Linux\2.1\en\builder\ in the CD-ROM and execute the following:
`expressclsbuilder- [version #] - [release #] .linux.i686.exe`
3. The following dialog box is displayed.

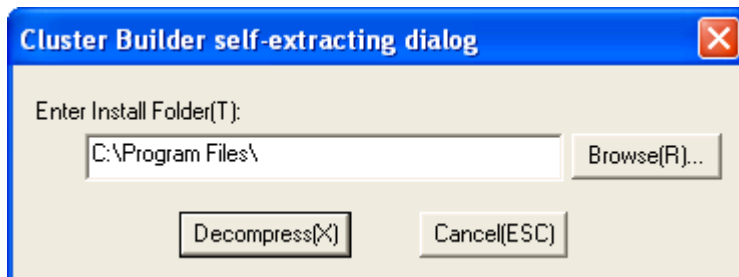

Specify an install folder and click **Decompress**. The default install folder is “Program Files”. In the folder specified here, “CLUSTERPRO\clpbuilder-l” directory is created. The Builder is installed in this directory.

When the installation is successfully completed, the following dialog box is displayed.

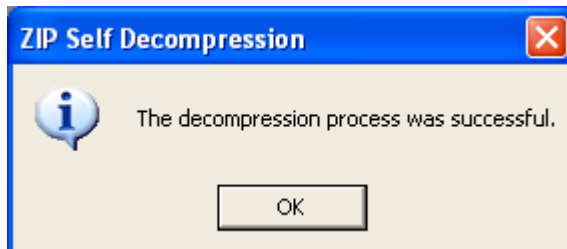

Note:

To change the location where the Builder is installed, move all files in your installation folder without changing the structure of the “clpbuilder-l” directory.

Starting the Builder

1. Load the following html file by a Web browser and start the Builder.

file:///Installation_path/clptrek.htm

If you start up the Builder for the first time, the following window is displayed.

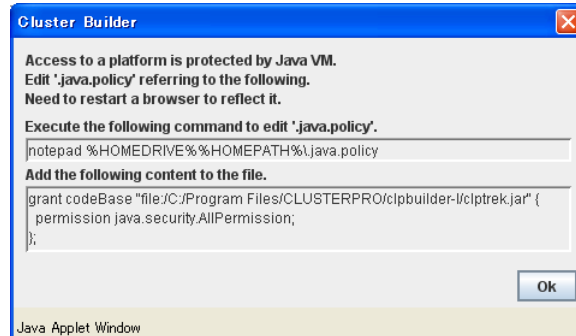

2. Configure the user policy file of Java to grant the Builder (Java applet) a right to access the platform OS (outside Java VM).

When OS of the management PC is Linux

Run the command `vi ~/.java.policy` shown in the window above. The `.java.policy` file in the home directory is displayed.

When OS of the management PC is Windows

On the **Start** menu, click **Run** and run the command `notepad %HOMEDRIVE%%HOMEPATH%\java.policy`, shown in the window above. The `.java.policy` file in the home directory is displayed. If the `.java.policy` file does not exist in the home directory, a message asking whether or not to create a new file is displayed. Click **Yes**.

Note:

When the OS is installed in the C drive and you are logging in by *USERNAME*, the home directory is `C:\Documents and Settings\USERNAME`. In some environments, this varies.

3. Copy the character string displayed below [**Add the following content to the file.**] shown in the window above to the `.java.policy` file, and then save it.
 4. Close all the Web browsers.
 5. Start the Builder again and confirm that it runs normally.
-

Note:

If the Builder does not start up successfully, check that JRE is installed on the computer. JRE is enabled on the browser.

The `.Java.policy` file exists in the home directory, and Builder installation path is specified.

Chapter 4 Registering the license

To run ExpressCluster as a cluster system, you need to register the license. This chapter describes how to register an ExpressCluster license.

This chapter covers:

- Registering the CPU license 70
- Registering the node license 74

Registering the CPU license

It is required to register the CPU license to run the cluster system you create.

Among servers that constitute the cluster, use the master server to register the CPU license. There are two ways of license registration; using the information on the license sheet and specifying the license file. These two ways are described for both the product and trial versions.

Product version

- ◆ Specify the license file as the parameter of the license management command. Refer to page 71, “Registering the license by specifying the license file (for both product version and trial version).”
- ◆ Register the license by running the license management command and interactively entering the license information that comes with the licensed product. Refer to page 72, “Registering the license interactively from the command line (Product version).”

Trial version

- ◆ Specify the license file as the parameter of the license management command. Refer to page 71, “Registering the license by specifying the license file (for both product version and trial version).”

Before registering the license, make sure that the procedures described in Chapter 5, “Creating the cluster configuration data using the Builder” in are executed on all servers.

Registering the license by specifying the license file (for both product version and trial version)

The following describes how to register the license by specifying the license file when you have a license for the product version or trial version.

Before you register the license, make sure to:

- ◆ Run the command to create the cluster. If you have not run the command yet, see “Creating a cluster” in Chapter 4 and run the command.
- ◆ Allow logon as root user to the server that will be set as a master server among servers that configures a cluster system.
- ◆ Store the license file in the server that will be set as a master server among servers that constitute the cluster system.

1. Log on to the master server as root user and run the following command.

```
# clplcns -i <filepath> -p <PRODUCT-ID>
```

Specify the path to the license file for *filepath* specified by the *-i* option. Specify the product ID for *PRODUCT-ID* specified by the *-p* option. Enter the product ID that corresponds to the version you are using. The product ID is listed below:

Licensed Product Name	Product ID
ExpressCluster X 2.1 for Linux	BASE21
ExpressCluster X SingleServerSafe for Linux Upgrade	UPGR21
ExpressCluster X SingleServerSafe 2.1 for Linux	XSS21

When the command is successfully executed, the message “Command succeeded.” is displayed in the console. When a message other than this is displayed, see Chapter 4, “ExpressCluster command reference” in the *Reference Guide*.

2. Run the following command to verify the licenses registered. In *PRODUCT-ID*, enter the product ID. For *PRODUCT-ID*, enter the product ID specified on step 1 of this procedure.

```
# clplcns -l -p <PRODUCT-ID>
```

3. When an optional product is used, refer to page 74, “Registering the node license” in this chapter.
4. When an optional product is not used, run the OS shutdown command to reboot all servers. By doing this, the license registration becomes effective and you can start using the cluster. After rebooting all servers, proceed to Chapter 5, “Creating the cluster configuration data using the Builder” and follow the steps.

Note:

You can ignore that `clusterori_md` fails at the time the operating system is started up. It is because the cluster is yet to be created.

Registering the license interactively from the command line (Product version)

The following describes how you register a license for the product version interactively from the command line.

Before you register the license, make sure to:

- ◆ Have the official license sheet that comes with the product.
- ◆ Run the command to create the cluster. If you have not run the command yet, see “Creating a cluster” in Chapter 4 and run the command.
- ◆ Allow logon as root user to the server that will be set as a mater server among servers that constitute the cluster system.

Related Information:

The `clplcncs` command is used in the following procedures. For more information on how to use the `clplcncs` command, see Chapter 4, “ExpressCluster command reference” in the *Reference Guide*.

1. Have the license sheet.

The instruction here is given using the values in the following license sheet as an example. When actually entering the values, modify them according to the information on your license sheet.

Product name:	<u>ExpressCluster X 2.1 for Linux</u>
License information:	
Type	Product Version
License Key	A1234567- B1234567- C1234567- D1234567
Serial Number	AAA0000000
Number Of Licensed CPUs	2

2. Log on to the master server as root user and run the following command.

```
# clplcncs -i -p PRODUCT-ID
```

Specify the product ID for *PRODUCT-ID* specified by the `-p` option. Enter the product ID that corresponds to the version you are using. The product ID is listed below:

Licensed Product Name	Product ID
ExpressCluster X 2.1 for Linux	BASE21
ExpressCluster X SingleServerSafe for Linux Upgrade	UPGR21
ExpressCluster X SingleServerSafe 2.1 for Linux	XSS21

3. The text that prompts you to enter the product division is displayed. Enter **1** to select “product version” for license version:

```
Selection of License Version.
1. Product version
2. Trial version
Select License Version. [1 or 2 ] ...1
```

4. The text that prompts you to enter the number of licenses is displayed. The default value 2 is set for the number of licenses. If the number written in your license sheet is 2, simply press ENTER without entering any value. When the value written in your license sheet is other than 2, enter the correct value and press ENTER.

```
Enter the number of license [1 to 99 (default:2)] ... 2
```

5. The text that prompts you to enter the serial number is displayed. Enter the serial number written in your license sheet. Note this is case sensitive.

```
Enter serial number [Ex. XXX0000000] ... AAA0000000
```

6. The text that prompts you to enter the license key is displayed. Enter the license key written in your license sheet. Note this is case sensitive.

```
Enter license key
[XXXXXXXX-XXXXXXXX-XXXXXXXX-XXXXXXXX] ...
A1234567-B1234567-C1234567-D1234567
```

When the command is successfully executed, the message “Command succeeded” is displayed in the console. When a message other than this is displayed, see Chapter 4, “ExpressCluster command reference” in the *Reference Guide*.

7. Run the following command to verify the licenses registered. In PRODUCT-ID, enter the product ID specified in Step 2.

```
# clplcns -l -p PRODUCT-ID
```

8. When an optional product is used, refer to page 74, “Registering the node license” in this chapter.
9. When an optional product is not used, run the OS shutdown command to reboot all servers. By doing this, the license registration becomes effective and you can start using the cluster. After rebooting all servers, proceed to Chapter 5, “Creating the cluster configuration data using the Builder” and follow the steps.

Note:

You can ignore that clusterori_md fails at the time the operating system is started up. It is because the cluster yet to be created.

Registering the node license

It is required to register the node license for the X 2.1 Replicator, X 2.1 Replicator DR, X 2.1 Agent products, and X 2.1 Alert Service (hereafter referred to as “optional product”) to operate the cluster system where those products are constituted.

Among servers constituting the cluster, register the node license on the server that uses an optional product. There are two ways of license registration; using the information on the license sheet and specifying the license file. These two ways are described for both the product and trial versions.

Product version

- ◆ Register the license by running the license management command and interactively entering the license information that comes with the licensed product. Refer to page 76, “Registering the node license interactively from the command line (Product version).”
- ◆ Specify the license file as the parameter of the license management command. Refer to page 74, “Registering the node license by specifying the license file (for both product version and trial version).”

Trial version

- ◆ Specify the license file as the parameter of the license management command. Refer to page 74, “Registering the node license by specifying the license file (for both product version and trial version).”

Registering the node license by specifying the license file (for both product version and trial version)

The following describes how you register the license by specifying the license file when you have a license for the product version or trial version.

Before you register the license, make sure to:

- ◆ Run the command to create the cluster. If you have not run the command yet, see “Creating a cluster” in Chapter 3 and run the command.
 - ◆ Allow log on as root user to the server for which you use an optional product.
1. Among servers of which you intend to construct a cluster and use the optional product, log on to the server you plan to use as a master server as root user and run the following command.

```
# clplcns -i filepath -p PRODUCT-ID
```

Specify the path to the license file for *filepath* specified by the `-i` option. Specify the product ID for *PRODUCT-ID* specified by the `-p` option. For details on product ID, refer to the *Reference Guide*.

For *PRODUCT-ID* specified by the `-p` option, specify the production ID. The product ID is listed below.

License Product Name	Product ID
ExpressCluster X Replicator 2.1 for Linux	REPL21
ExpressCluster X Database Agent 2.1 for Linux	DBAG21
ExpressCluster X Internet Server Agent 2.1 for Linux	ISAG21
ExpressCluster X File Server Agent 2.1 for Linux	FSAG21
ExpressCluster X Application Server Agent 2.1 for Linux	ASAG21
ExpressCluster X Alert Service 2.1 for Linux	ALRT21
ExpressCluster X Replicator DR 2.1 for Linux	RPDR21
ExpressCluster X Replicator DR 2.1 for Linux Upgrade	RPUP21

When the command is successfully executed, the message “Command succeeded” is displayed in the console. When a message other than this is displayed, see Chapter 4, “ExpressCluster command reference” in the *Reference Guide*.

- Run the following command to verify the licenses registered. In **PRODUCT-ID**, enter the product ID specified in Step 1 of this procedure.

```
# clplcns -l -p PRODUCT-ID
```

- If there is other server in a cluster system that uses the optional product, register the node license by following the same procedures. Register the license for the Replicator to both servers.
- Run the OS shutdown command to reboot all the servers. By doing this, the license registration becomes effective and you can start using the cluster. After rebooting all servers, proceed to Chapter 5, “Creating the cluster configuration data using the Builder” and follow the steps.

When the license for the Replicator is registered after you have started using the cluster, shut down and reboot the cluster. The Replicator becomes available after rebooting the cluster.

Note:

You can ignore that clusterori_md fails at the time the operating system is started up. It is because the cluster is yet to be created.

If the Replicator license is registered after starting the cluster operation, once shutdown and reboot the cluster. After the reboot, the Replicator is operable.

Registering the node license interactively from the command line (Product version)

The following describes how you register the license for the product version interactively from the command line.

Before you register the license, make sure to:

- ◆ Have the official license sheet that comes with the product. The license sheet is sent to you when you purchase the product. The number of license sheets required is the number of servers for which you use the optional product. You will enter the values on the license sheet.
- ◆ Run the command to create the cluster. If you have not run the command, see “Creating a cluster” in Chapter 4 and run the command.
- ◆ Allow logon as root user to the server for which you plan to use the option product among servers constituting the cluster system.

Related Information:

The `clplcns` command is used in the following procedures. For more information on how to use the `clplcns` command, see Chapter 4, “ExpressCluster command reference” in the *Reference Guide*.

1. Have the license sheet.

The instruction here is given using the values in the following license sheet (Replicator) as an example. When actually entering the values, modify them according to the information on your license sheet.

Product name:	<u>ExpressCluster X Replicator 2.1 for Linux</u>
License information:	
Type	Product Version
License Key	A1234567- B1234567- C1234567- D1234567
Serial Number	AAA0000000
Number of Nodes	1

2. Among servers that constitute the cluster, log on as root user to the server for which you are intending to use the option product as root, and then run the following command:

```
# clplcns -i -p PRODUCT-ID
```

Specify the product ID for *PRODUCT-ID* specified by the `-p` option. Enter the product ID that corresponds to the version you are using. The product ID is listed below:

Licensed Product Name	Product ID
ExpressCluster X Replicator 2.1 for Linux	REPL21
ExpressCluster X Database Agent 2.1 for Linux	DBAG21
ExpressCluster X Internet Server Agent 2.1 for Linux	ISAG21
ExpressCluster X File Server Agent 2.1 for Linux	FSAG21
ExpressCluster X Application Server Agent 2.1 for Linux	ASAG21
ExpressCluster X Alert Service 2.1 for Linux	ALRT21

ExpressCluster X Replicator DR 2.1 for Linux	RPDR21
ExpressCluster X Replicator DR 2.1 for Linux Upgrade license	RPUP21

- The text that prompts you to enter the license version is displayed. Enter **1** since it is a product version:

```
Selection of License Version.
1. Product Version
2. Trial Version
Select License Version. [1 or 2 ] ...1
```

- The text that prompts you to enter the serial number is displayed. Enter the serial number written in your license sheet. Note this is case sensitive.

```
Enter serial number [Ex. XXX0000000]... AAA0000000
```

- The text that prompts you to enter the license key is displayed. Enter the license key written in your license sheet. Note this is case sensitive.

```
Enter license key
[XXXXXXXX-XXXXXXXX-XXXXXXXX-XXXXXXXX]...
A1234567-B1234567-C1234567-D1234567
```

When the command is successfully executed, the message “Command succeeded” is displayed in the console. When a message other than this is displayed, see Chapter 4, “ExpressCluster command reference” in the *Reference Guide*.

- Run the following command to verify the licenses registered. In **PRODUCT-ID**, enter the product ID specified in the Step 2.

```
# clplcnc -l -p PRODUCT-ID
```

- If there is any other server in the cluster that uses an optional product, register the node license by repeating the same steps.

- Run the OS shutdown command to reboot all the servers. By doing this, the license registration becomes effective and you can start using the cluster. After rebooting all servers, proceed to Chapter 5, “Creating the cluster configuration data using the Builder” and follow the steps.

When the license for the Replicator is registered after you have started using the cluster, shut down and reboot the cluster. The Replicator becomes available after rebooting the cluster.

Note:

You can ignore that clusterori_md fails at the time the operating system is started up. It is because the cluster is yet to be created.

If the Replicator license is registered after starting the cluster operation, once shutdown and reboot the cluster. After the reboot, the Replicator is operable.

Chapter 5 Creating the cluster configuration data using the Builder

In ExpressCluster, data that contains information on how a cluster system is configured is called “cluster configuration data.” Generally, this data is created using the Builder which is started on the WebManager. This chapter provides the procedures to start up the WebManager and to create the cluster configuration data using the Builder with a sample cluster configuration.

This chapter covers:

- Creating the cluster configuration data 80
- Starting up the ExpressCluster X WebManager..... 81
- Starting the Builder 84
- Checking the values to be configured in the cluster environment with 2 nodes..... 85
- Creating the configuration data of a 2-nodes cluster 89
- Checking the values to be configured in the cluster environment with 3 nodes..... 102
- Creating the configuration data of a 3-nodes cluster 107
- Checking the values to be configured in the cluster environment with 3 nodes (hybrid type) 126
- Creating the configuration data of a 130
- Saving the cluster configuration data..... 150
- Creating a cluster..... 154

Creating the cluster configuration data

Creating the cluster configuration data is performed by using the ExpressCluster X Builder (hereafter described as the Builder), the function for creating and modifying cluster configuration data

Create the cluster configuration data by starting the Builder from the ExpressCluster WebManager (hereafter described as the WebManager) accessed from the management PC. The cluster configuration data will be reflected in the cluster system by the Builder.

Starting up the ExpressCluster X WebManager

Accessing to the WebManager is required to create cluster configuration data. This section describes the overview of the WebManager, the access to the WebManager, and how to create cluster configuration data.

Related Information:

For the system requirements of the WebManager, refer to Chapter 3, "Installation requirements for ExpressCluster" in the *Getting Started Guide*.

What is ExpressCluster X WebManager?

The ExpressCluster X WebManager is a function to start the Builder, monitor the cluster status, start up and stop servers and groups, and collect cluster operation logs through a Web browser. The overview of the WebManager is shown in the following figures.

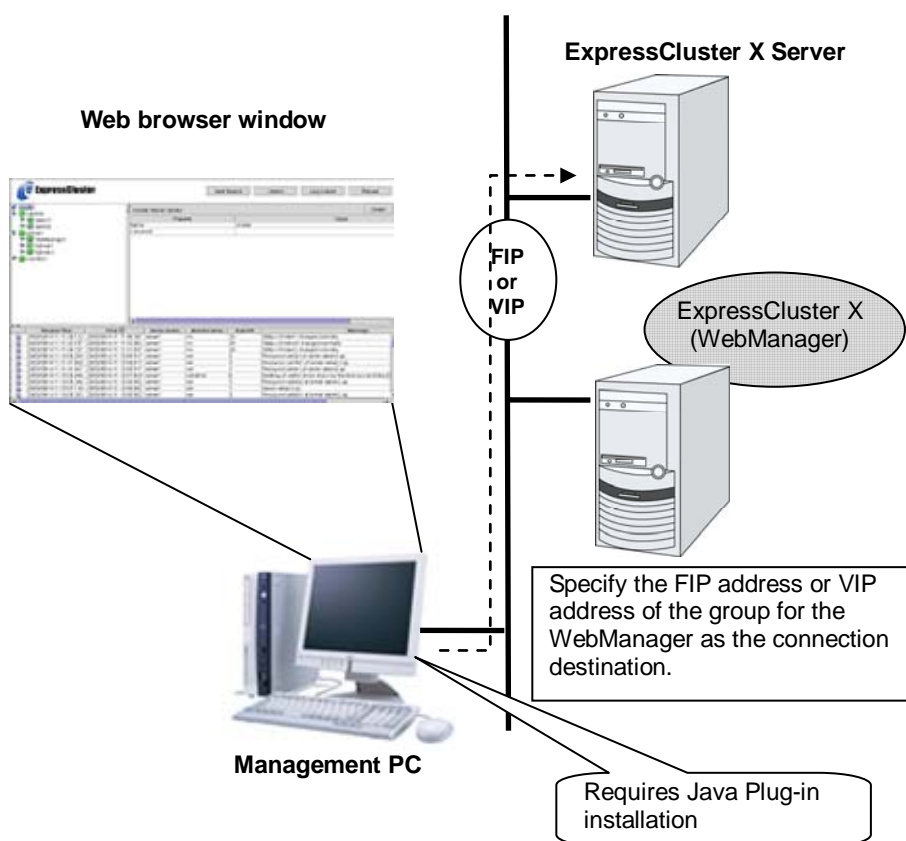

The WebManager in ExpressCluster Server is configured to start up at the time when the operating system starts up.

Browsers supported by the WebManager

For information of the latest system requirements of the WebManager (supported operating systems and browsers, Java runtime environment, required memory and disk size), see the *Getting Started Guide*.

Setting up JAVA runtime environment to a management PC

In order to access the WebManager, a Java Plug-in must be installed on a browser on a management PC.

To install Java Plug-in on a browser, refer to the browser's help and the JavaVM installation guide.

Starting the WebManager

Start the WebManager to use the Builder.

1. Start your Web browser.
2. Enter the actual IP address and port number of the server where the ExpressCluster Server is installed in the Address bar of the browser.

http://10.0.0.11:29003/

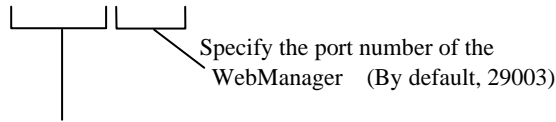

Specify the actual IP address of the server on which the ExpressCluster Server is installed.

WebManager starts up.

Starting the Builder

Note:

If you click **Settings** on the title bar of the WebManager several times while the pointer of the WebManager is displayed as an hourglass, the Builder may freeze. Make sure not to operate anything while the pointer of the WebManager appears as an hourglass.

1. On the title bar of the WebManager, click **Settings** to start up the Builder. If you start up the Builder for the first time, the following window is displayed.

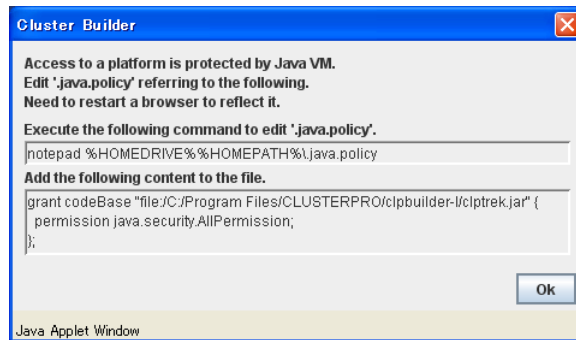

2. Configure the user policy file of Java to grant the Builder (Java applet) a right to access the platform OS (outside Java VM).

When OS of the management PC is Linux

Run the command `vi ~/.java.policy` shown in the window above. The `.java.policy` file in the home directory is displayed.

When OS of the management PC is Windows

On the **Start** menu, click **Run** and run the command `notepad %HOMEDRIVE%%HOMEPATH%.java.policy`, shown in the window above. The `.java.policy` file in the home directory is displayed. If the `.java.policy` file does not exist in the home directory, a message asking whether or not to create a new file is displayed. Click **Yes**.

Note:

When the OS is installed in the C drive and you are logging in by `USERNAME`, the home directory is `C:\Documents and Settings\USERNAME`. In some environments, this varies.

3. Copy the character string displayed below [Add the following content to the file.] shown in the window above to the `.java.policy` file, and then save it.
 4. Close all the Web browsers.
 5. Connect to the WebManager again and click **Settings** to start up the Builder.
-

Note:

If the Builder does not start up successfully, check that;
 JRE is installed on the computer.
 JRE is enabled on the browser.
`.Java.policy` file is in the home directory and the installation path of the Builder is specified.

The `.Java.policy` file exists in the home directory, and Builder installation path is specified.

Checking the values to be configured in the cluster environment with 2 nodes

Before you create the cluster configuration data using the Builder, check values you are going to enter. Write down the values to see whether your cluster is efficiently configured and there is no missing information.

Sample cluster environment

As shown in the diagram below, this chapter uses a typical configuration with two nodes as a cluster example.

When a disk resource is used:

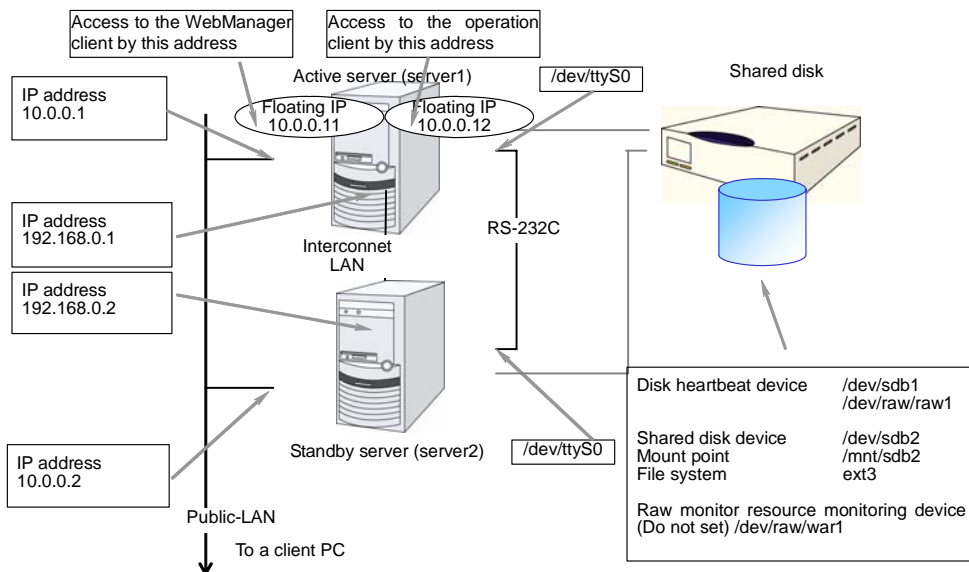

When mirror disk resources are used:

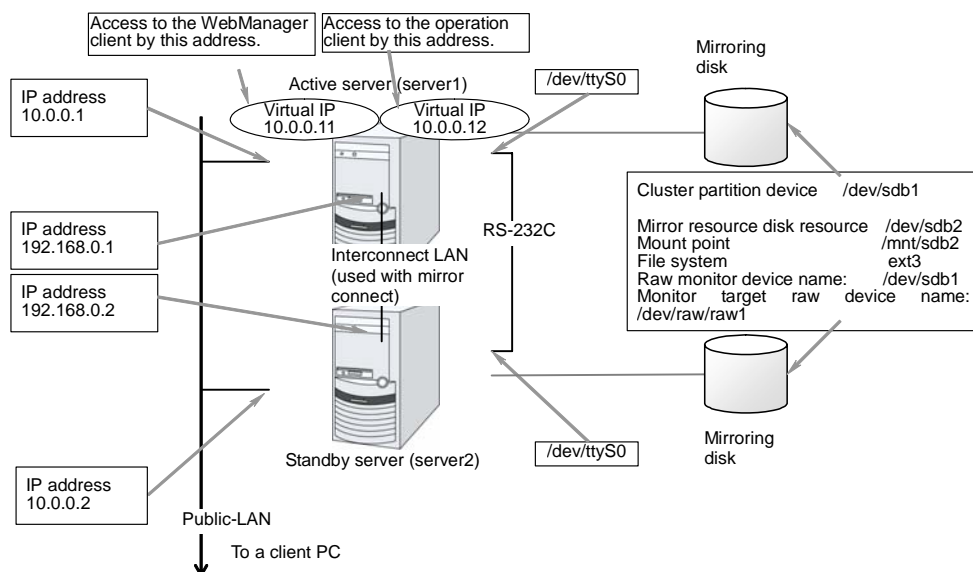

Check the values to be configured before creating the cluster configuration data. The following table lists sample values of the cluster configuration data to achieve the cluster system shown above. These values and configuration are applied hereafter in the step-by-step instruction to create the cluster configuration data. When you actually set the values, you may need to modify them according to the cluster you are intending to create. For information on how you determine the values, refer to the *Referenced Guide*.

Example of configuration with 2 nodes

Target	Parameter	Value (For disk resource)	Value (For mirror disk resource)
Cluster configuration	Cluster name	cluster	cluster
	Number of servers	2	2
	Number of failover groups	2	2
	Number of monitor resources	4	6
Heartbeat resources	Number of LAN heartbeats	2	2
	Number of kernel mode LAN heartbeats	2	2
	Number of COM heartbeats	1	1
	Number of disk heartbeats	1	0
First server information (Master server)	Server name*1	server1	server1
	Interconnect IP address (Dedicated)	192.168.0.1	192.168.0.1
	Interconnect IP address (Backup)	10.0.0.1	10.0.0.1
	Public IP address	10.0.0.1	10.0.0.1
	COM heartbeat device	/dev/ttyS0	/dev/ttyS0
	Disk heartbeat device	/dev/sdb1	--
	Disk heartbeat raw device	dev/raw/raw1	--
	Mirror disk connect	--	192.168.0.1
Second server information	Server name*1	server2	server2
	Interconnect IP address (Dedicated)	192.168.0.2	192.168.0.2
	Interconnect IP address (Backup)	10.0.0.2	10.0.0.2
	Public IP address	10.0.0.2	10.0.0.2
	COM heartbeat device	/dev/ttyS0	/dev/ttyS0
	Disk heartbeat device	/dev/sdb1	--
	Disk heartbeat raw device	/dev/raw/raw1	--

Target	Parameter	Value (For disk resource)	Value (For mirror disk resource)
	Mirror disk connect	--	192.168.0.2
Group resources for management (For the WebManager)	Type	failover	failover
	Group name	ManagementGroup	ManagementGroup
	Startup server	All servers	All servers
	Number of group resources	1	1
Group resources for management *2	Type	floating IP resource	floating IP resource
	Group resource name	WebManager FIP1	WebManager FIP1
	IP address	10.0.0.11	10.0.0.11
Group resources for operation	Type	failover	failover
	Group name	failover1	failover1
	Startup server	All the servers	All the servers
	Number of group resources	3	3
First group resources	Type	floating IP resource	floating IP resource
	Group resource name	fip1	fip1
	IP address	10.0.0.12	10.0.0.12
Second group resources	Type	disk resource	mirror disk resource
	Group resource name	disk1	md1
	Device name	/dev/sdb2	
	Mount point	/mnt/sdb2	
	File system	ext3	
	Disk type	disk	
	Mirror partition device name		/dev/NMP1
	Mount point		/mnt/sdb2
	Data partition device name		/dev/sdb2
	Cluster partition device name		/dev/sdb1
	Disk device name		/dev/sdb
	File system		ext3
	Mirror data port number		29051
Third group resources	Type	exec resource	exec resource
	Group resource name	exec1	exec1
	Script	Standard Script	Standard Script
First monitor resources (Created by default)	Type	user mode monitor	user mode monitor
	Monitor resource name	userw	userw
Second monitor	Type	raw monitor	raw monitor

Target	Parameter	Value (For disk resource)	Value (For mirror disk resource)
resources	Monitor resource name	raww1	raww1
	Monitored target raw device	/dev/raw/raw1	/dev/raw/raw1
	Device name	--	/dev/sdb1
	When error is detected	Stop the cluster daemon and shut down OS	Stop the cluster daemon and shut down OS
Third monitor resources	Type	NIC Link Up/Down monitor	NIC Link Up/Down monitor
	Monitor resource name	miiw1	miiw1
	Monitored target	eth0 (Interface of Public LAN)	eth0 (Interface of Public LAN)
	When error is detected	"ManagementGroup" group's failover *2	"ManagementGroup" group's failover *3
Fourth monitor resources	Type	NIC Link Up/Down monitor	NIC Link Up/Down monitor
	Monitor resource name	miiw2	miiw2
	Monitored target	eth0 (Interface of Public LAN)	eth0 (Interface of Public LAN)
	When error is detected	"failover1" group's Failover *2	"failover1" group's Failover *3
Fifth monitor resource (Automatically created after creating mirror disk resource)	Type		mirror disk connect monitor
	Monitor resource name		mdnw1
	Monitored mirror disk resource		md1
	When error is detected		No Operation
Sixth monitor resource (Automatically created after creating mirror disk resource)	Type		mirror disk monitor
	Monitor resource name		mdw1
	Monitored mirror disk resource		md1
	When error is detected		No Operation

*1: "Host name" represents the short name that excludes the domain name from a frequently qualified domain name (FQDN).

*2: You should have a floating IP address to access the WebManager. You can access the WebManager from your Web browser with a floating IP address when an error occurs.

*3: For the settings to execute a failover when all interconnect LANs are disconnected, see Chapter 6, "Monitor resource details" in the *Reference Guide*.

Creating the configuration data of a 2-nodes cluster

Creating the cluster configuration data involves creating a cluster, group resources, and monitor resources. The steps you need to take to create the data are described in this section.

Note:

The following instruction can be repeated as many times as necessary. Most of the settings can be modified later by using the rename function or properties view function.

1. Create a cluster

Add a cluster you want to construct and enter its name.

1-1. Add a cluster

Add a cluster you want to construct and enter its name.

1-2. Add the first server

Add a server. Make settings such as IP addresses.

1-3. Add the second server

Add a server. Make settings such as IP addresses.

2. Create a failover group

Create a failover group that works as a unit when a failover occurs.

2-1. Add a group for management

Add a group that works as a unit when a failover occurs.

2-2. Add a group for operation

Add a resource that constitutes a group.

2-3. Add a group resource (floating IP address)

Add a resource that constitutes a group.

2-4. Add a group resource (disk resource)

Add a resource that constitutes a group when the disk resource is used.

2-5. Add a group resource (mirror disk resource)

Add a resource that constitutes a group when the mirror disk resource is used.

2-6. Add a group resource (EXEC resource)

Add a resource that constitutes a group.

3. Create monitor resources

Create a monitor resource that monitors specified target in a cluster.

3-1. Add a monitor resource (raw monitor resource)

Add a monitor resource to use.

3-2. Add a monitor resource (NIC Link Up/Down monitor resource for management)

Add a monitor resource to use.

3-3. Add a monitor resource (NIC Link Up/Down monitor resource for failover group)

Add a monitor resource to use.

1. Creating a cluster

Create a cluster. Add a server that constitute a cluster and determine a heartbeat priority.

1-1. Add a cluster

1. On the **File** menu of the Builder, click **Cluster Generation Wizard**. The **Cluster Generation Wizard** is displayed.

Note: On the WebManager, only one language is available within one cluster. If multiple languages are used within a cluster, specify English to avoid garbled characters

2. In the **Cluster Definition** dialog box, type the cluster name (cluster) in the **Name** box, and then click **Next**.

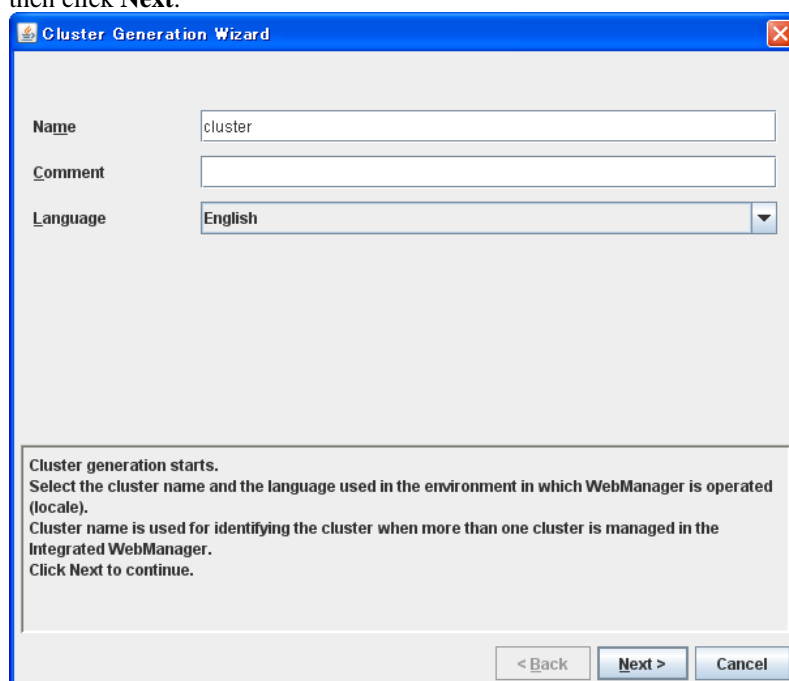

1-2. Add the first server

Add information of each server that constitutes a cluster.

1. The **Server Definitions** list is displayed.

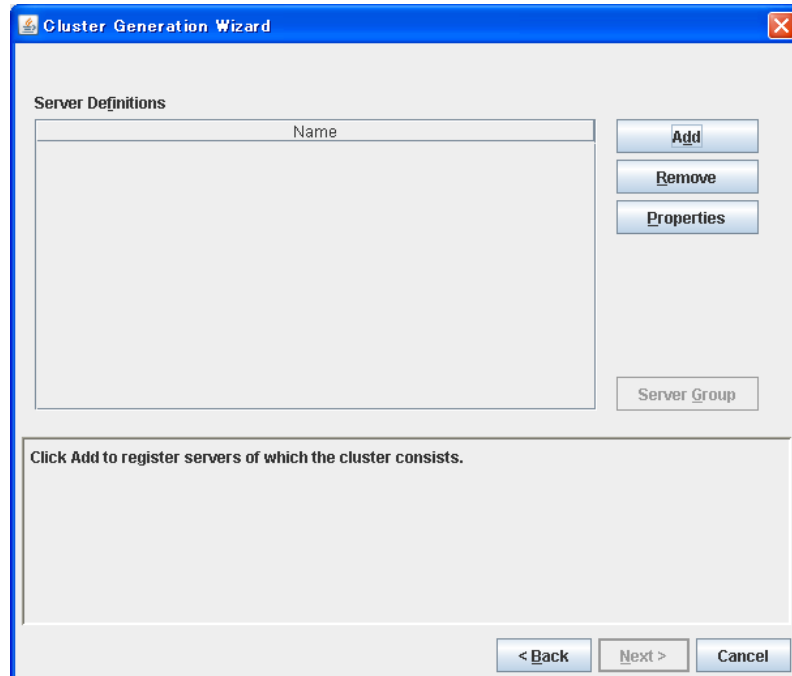

2. In the **Server Definitions** list, click **Add**.
3. The **Server Definition** dialog box is displayed. Enter the data of the first server. Enter the server name (**server1**) in the **Name** box, and then click **Next**.

Note:

Enter the actual host name of the server. Make sure to type it correctly because the information you enter here is case sensitive.

4. Set up an interconnect LAN. Click **Add** and enter the interconnect IP address (dedicated) **192.168.0.1** in the **IP Address** box. Click **OK**.
5. The IP address you have entered is displayed in **Interconnect LAN I/F**. Enter the interconnect LAN IP address (backup) **10.0.0.1**. Click **Next**.
6. Click **Add** and enter the IP address of the public LAN **10.0.0.1** in the **IP Address** box. Click **OK**.
7. The IP address you have entered is set in **Public LAN I/F**. Click **Next**.
8. To send a heartbeat using RS-232C, click **Add** and enter COM heartbeat device name in the **Device Name** box. (Typically, leave the default name as it is.) Click **OK**.
9. The device name you have entered is set in the **COM I/F**. Click **Next**.
10. When a shared disk is not used in the cluster environment, nothing needs to be configured. Click **Next** and proceed to Step 11. When a shared disk used, click **Add** and enter the actual device name **/dev/sdb1** in the **Device Name** box and the device name for raw access **/dev/raw/raw1** in the **Raw Device** box. Click **OK**.

Note:

The raw device specified here is used for the heartbeat. Note that it is not a value for a raw monitor resource.

11. The devices entered are set in the **Disk I/F**. Click **Next**.

12. Nothing needs to be configured in **Ping I/F**. Click **Next**.
13. When a cluster system is not a data mirror type, nothing needs to be configured. Click **Next** and proceed to Step 13. When a cluster system is a data mirror type, click **Add** and enter the IP address of the mirror disk connect **192.168.0.1** in **IP Address**. Click **OK**. The IP address entered is registered with **Mirror Disk Connect I/F**.
14. Click **Finish**.

The **Server Definitions** should look similar to the following. The server defined first becomes the master server by default.

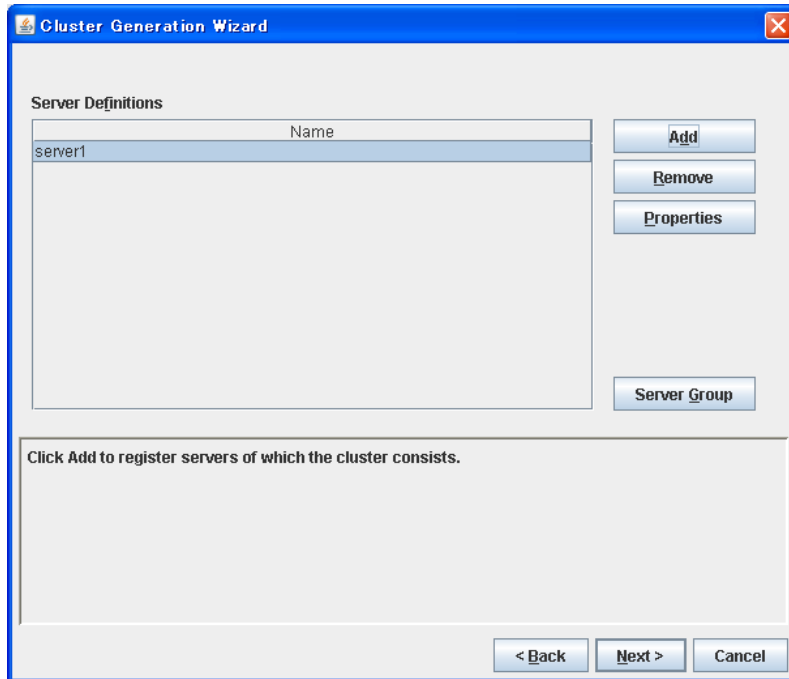

1-3. Add the second server

Enter the second server information after the first server information.

1. In the **Server Definitions** list, click **Add**.
2. In the **Server Definition** dialog box, enter the data of the second server. Enter the server name **server2** in the **Name** box, and then click **Next**.

Note: Enter the actual host name of the server. The information you enter here is case sensitive.

3. When you define the second server and rest of servers, you will see I/Fs in definition as many as you find in the master server. The IP address is blank by default. Set the IP address corresponding to the I/F number registered in other servers. Click **Edit** and enter the interconnect LAN IP address (dedicated) **192.168.0.2** in the **IP Address** box. Click **OK**.
4. The IP address you have entered is set in **Interconnect LAN I/F**. Likewise, select [**2**] of **I/F No.**, click **Edit**, and enter the LAN IP address (Backup) **10.0.0.2**. Click **Next**.
5. Click **Edit** and enter the public IP address **10.0.0.2** in the **IP Address** box. Click **OK**.
6. Check to see the IP address you have entered in the **Public LAN I/F** is set. Click **Next**.
7. When a heartbeat using RS-232C is sent, the device name is displayed in **COM I/F**. The number of interfaces as many as you see in the master server is displayed. The COM heartbeat device name of the master server is set by default. Click **Next** without changing the settings.
8. When a shared disk is not used in the cluster environment, nothing needs to be configured. Click **Next** and proceed to Step 9. When a shared disk used, the number of interfaces in the master server is displayed. The disk device name and raw device name of a master server are set by default. Click **Next** without changing the settings.
9. Nothing needs to be configured in **Ping I/F**. Click **Next**.
10. If a cluster system is not a data mirror type, nothing needs to be configured. Click **Finish** without configuring. In server definition after the second server, the same number of I/F as the master server I/F is displayed. Configure an IP address corresponding to I/F number registered to other servers. Verify that the IP address entered is registered to **Mirror Disk Connect I/F**. Click **Finish**.

The Server Definitions should look similar to the following.

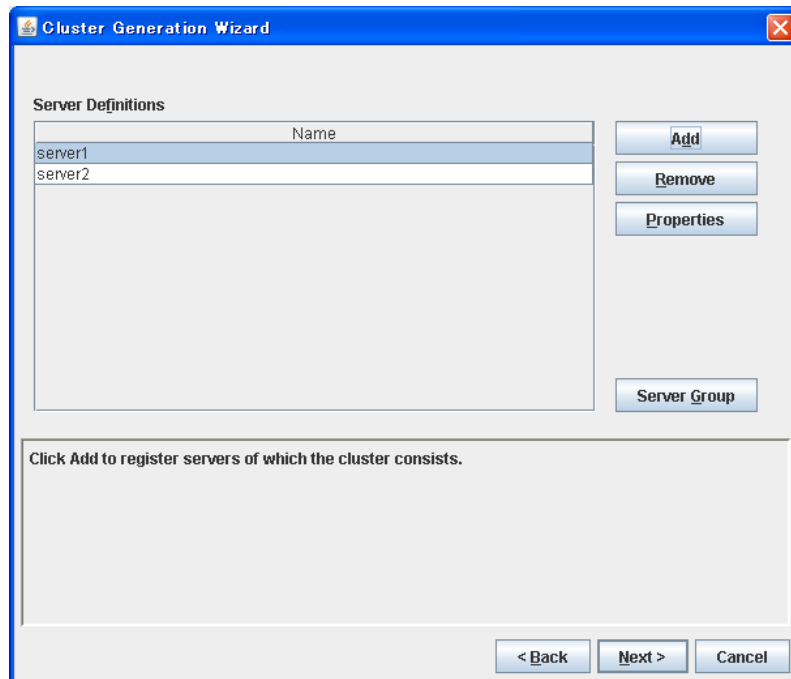

2. Creating a failover group

Add a failover group to the cluster. First, create a failover group for management and then add a failover group that executes an application.

2-1. Add a group for management

When you add a group to a failover group, first create a group for the WebManager. This group uses a floating IP and accesses servers in the cluster from a management PC. This allows access from the WebManager to a server that has failed over even if one of the servers goes down and failover occurs.

1. Click **Next** on the **Server Definition**.
2. The **Group Definitions** list is displayed.

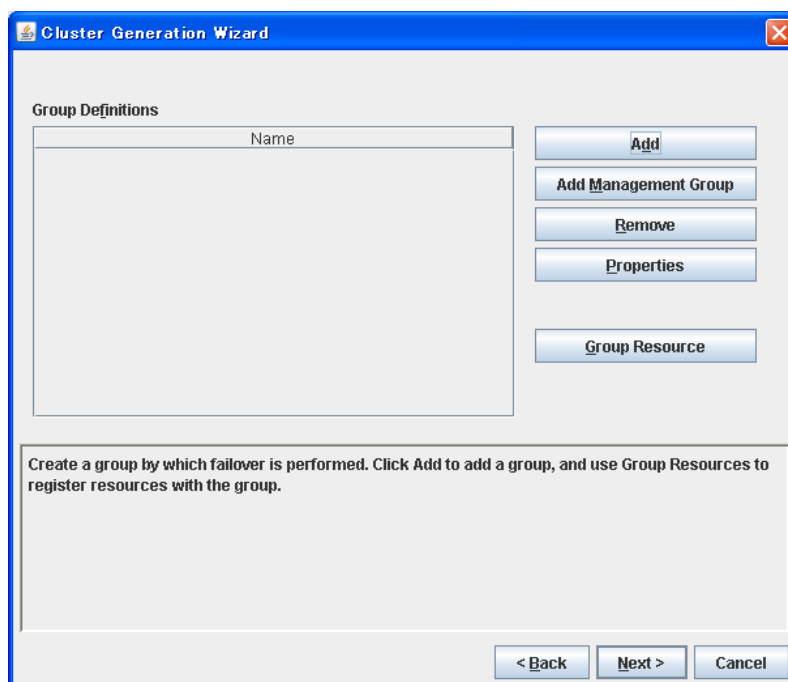

3. Click **Add Management Group**. **ManagementGroup** is added and displayed in the Group Definitions list.
4. Click **Group Resource** with **ManagementGroup** selected. **Group Resource Definitions** is displayed. Click **Add**.
5. In the **Type** box, select the group resource type (floating ip resource). In the **Name** box, the default name (ManagementIP) is entered. Click **Next**.
6. Enter the floating IP address (10.0.0.11) in the **IP Address** box, and then click **Next**.
7. **Recovery Operation at Activation Failure Detection** and **Recovery Operation at Deactivation Failure Detection** are displayed. Click **Next**.
8. A page for setting up a dependency is displayed. Click **Finish**.

9. **Group Resource Definitions** is displayed. Confirm that the Management IP is registered, and then click **Close**.

A group for management is added. The **Cluster Generation Wizard** should look similar to the following:

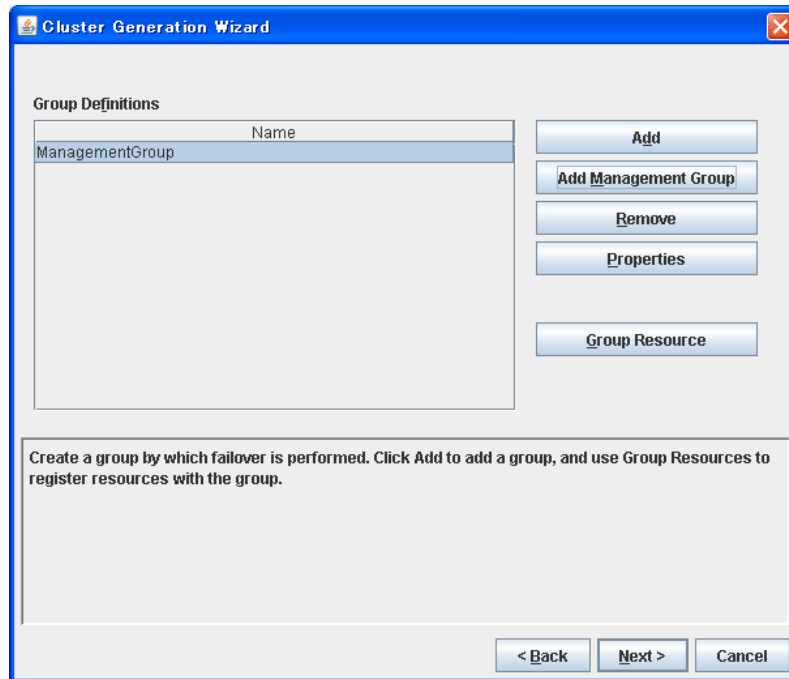

2-2. Add a group for operation

Set up a group that works as a unit of failover at the time an error occurs.

1. In the **Group Definitions** list, click **Add**.
2. In the **Group Definition** dialog box, enter the group name (failover1) in the **Name** box, and click **Next**.
3. Confirm that **Failover is possible at all servers** is selected, and then click **Finish**.

A failover group is added. The **Group Definitions** list should look similar to the following:

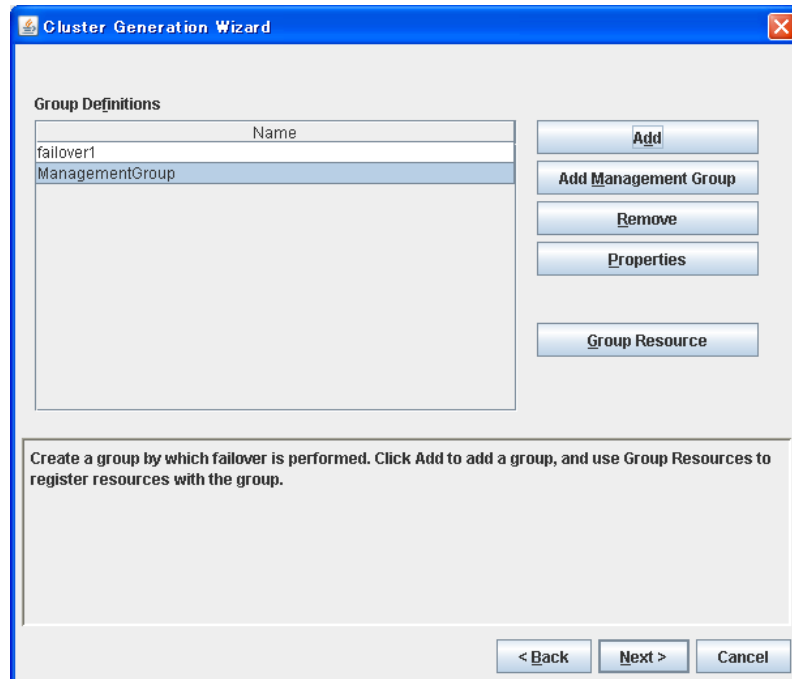

2-3. Add a group resource (floating IP address)

Add a group resource, a configuration element of the group, to the failover group you have created in Step 2-2.

1. In the **Group Definitions** list, click **Group Resource** with failover1 selected.
2. Click **Add** in the **Group Resource Definitions** list.
3. In the **Resource Definition** dialog box, select the group resource type **floating ip resource** in the **Type** box, and enter the group name **fip1** in the **Name** box. Click **Next**.
4. Enter the IP Address **10.0.0.12** in the **IP Address** box. Click **Next**.
5. **Recovery Operation at Activation Failure Detection** and **Recovery Operation at Deactivation Failure Detection** are displayed. Click **Next**.
6. A page for setting up a dependency is displayed. Click **Finish**.

2-4. Add a group resource (disk resource)

If a shared disk is used in a cluster system, add a shared disk as a group resource.

1. In the **Group Resource Definitions** list, click **Add**.
2. In the **Resource Definition** dialog box, select the group resource type **disk resource** in the **Type** box, and enter the group resource name **disk1** in the **Name** box. Click **Next**.
3. Enter the device name **/dev/sdb2**, mount point **/mnt/sdb2** to their corresponding boxes. Select the file system **ext3** from the **File System** box and the disk type **Disk** from the **Disk Type** box. Click **Next**.
4. **Recovery Operation at Activation Failure Detection** and **Recovery Operation at Deactivation Failure Detection** are displayed. Click **Next**.
5. A page for setting up a dependency is displayed. Click **Finish**.

2-5. Add a group resource (mirror disk resource)

If a cluster system is a data mirror type, add a mirror disk as a group resource.

1. In the **Group Resource Definitions** list, click **Add**.
2. The **Resource Definition** dialog box is displayed. Select the group resource type **mirror disk resource** in the **Type** box, and enter the group resource name **md1** in the **Name** box. Click **Next**.
3. Select the mirror partition device name **/dev/NMP1** in **Mirror Partition Device Name** box. Enter the mount point **/mnt/sdb2**, the data partition device name **/dev/sdb2**, the cluster partition device name **/dev/sdb1**, and the disk device name **/dev/sdb** in the respective box. In the **File System** dialog box, select the file system **ext3**. Click **Next**.
4. **Recovery Operation at Activation Failure Detection** and **Recovery Operation at Deactivation Failure Detection** are displayed. Click **Next**.
5. A page for setting up a dependency is displayed. Click **Finish**.

2-6. Add a group resource (exec resource)

Add an exec resource that can start and stop the application from a script.

1. In the **Group Resource Definitions** list, click **Add**.
2. In the **Resource Definition** dialog box, select the group resource **execute resource** in the **Type** box, and enter the group resource name **exec1** in the **Name** box. Click **Next**.
3. Select **Script created with this product**. Edit the script if applications to be used in ExpressCluster are already decided. Users may edit this script to describe the procedure to start and stop a group of applications. Click **Next**.
4. **Recovery Operation at Activation Failure Detection** and **Recovery Operation at Deactivation Failure Detection** are displayed. Click **Next**.
5. A page for setting up a dependency is displayed. Click **Finish**.

When a shared disk is used in a cluster system, the **Group Resource Definitions** list of the failover1 should look similar to the following:

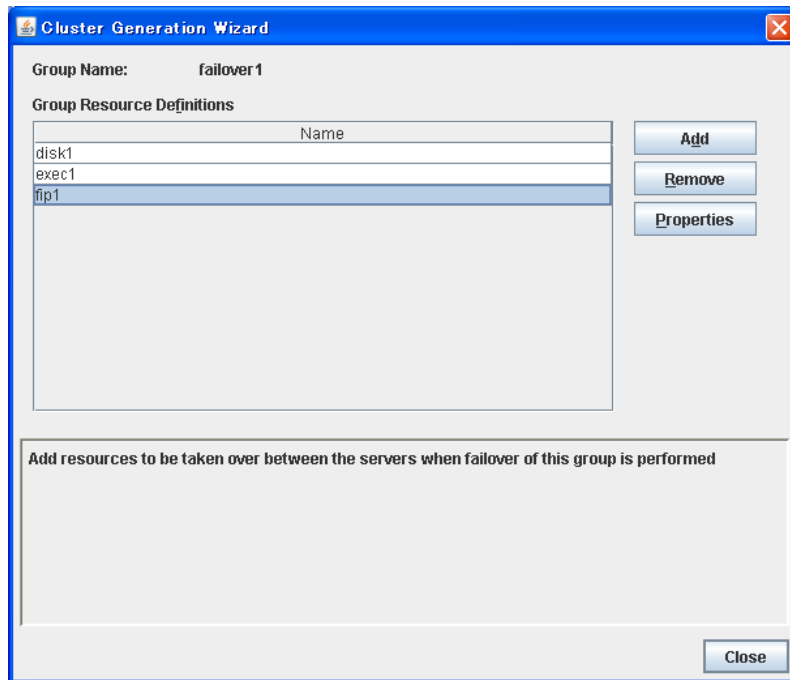

When a cluster system is a data mirror type, the **Group Resource Definitions** list of the failover1 should look similar to the following:

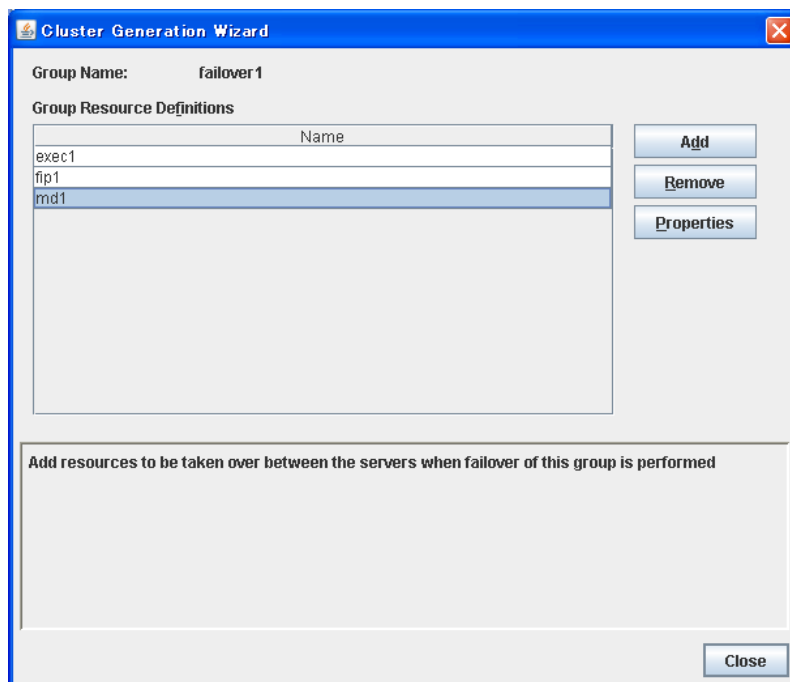

6. Click **Close**.

3. Creating monitor resources

Add a monitor resource that monitors a specified target to the cluster.

3.1 Add a monitor resource (raw monitor resource)

Add monitor resources to monitor the target disk. Raw monitor is used as an example of a monitor resource to be added.

1. In the **Group Definitions** list, click **Next**.
2. In the **Monitor Resource Definitions** list, click **Add**.
3. The **Monitor Resource Definition** dialog box is displayed. When a shared disk is used in the cluster environment, the first monitor resource information is created by default when the cluster name is defined. When a mirror disk is used in the cluster environment, the first monitor resource information is created by default when the cluster name is defined. The fifth and sixth monitor resource information is created by default when the mirror disk resource is added. Select the monitor resource type **raw monitor** in the **Type** box, and enter the monitor resource name **raww1** in the **Name** box. Click **Next**.
4. When a shared disk is used, enter the target monitor disk and raw device name (**/dev/raw/raw1**). Nothing needs to be entered in **Device Name**. When mirroring disks are used, enter the target monitor disk and raw device name (**/dev/raw/raw1**). Enter the device name (**/dev/sdb1**) in **Device Name**. Click **Next**.
5. Configure the monitor settings. Do not change the default value and click **Next**.
6. Specify the recovery target. Click **Browse**.
7. Click **cluster** in the tree view shown. Click **OK**.
8. Select **Stop the cluster daemon and shut down OS** in the **Final Action** box, and click **Finish**.

3-2. Add a monitor resource (NIC Link Up/Down monitor for management group)

Add monitor resources that monitor NIC. NIC Link Up/Down monitor needs to be created on a failover group basis. Because the example used here has two groups, a group for management and a group for an application. A NIC Link Up/Down monitor is created for each group.

1. In the **Monitor Resource Definitions** list, click **Add**.
2. In the **Monitor Resource Definition** dialog box, select the monitor resource type **NIC Link Up/Down monitor** in the **Type** box, and enter the monitor resource name **miw1** in the **Name** box. Click **Next**.
3. Enter the NIC (eth0) to be monitored in the **Monitor Target** box, and click **Next**.
4. Configure the monitor settings. Do not change the default value. Click **Next**.
5. Specify the recovery target. Click **Browse**.
6. Click **ManagementGroup** in the tree view and click **OK**. **ManagementGroup** is set in the **Recovery Target**.
7. Set **0** in the **Reactivation Threshold** box, and set **1** in the **Failover Threshold**. Click **Finish**.

3-3. Add a monitor resource (NIC Link Up/Down monitor resource for management group)

1. In the **Monitor Resource Definitions** list, click **Add**.
2. In the **Monitor Resource Definition** dialog box, select the monitor resource type **NIC Link Up/Down monitor** in the **Type** box, and enter the monitor resource name **miiw2** in the **Name** box. Click **Next**.
3. Enter the NIC (eth0) to be monitored in the **Monitor Target** box, and click **Next**.
4. Configure the monitor settings. Without changing the default value, click **Next**.
5. Specify the recovery target. Click **Browse**.
6. Click **failover1** in the tree view. Click **OK**. “failover1” is set in the **Recovery Target**.
7. Set **0** in the **Reactivation Threshold** box, and set **1** in the **Failover Threshold**. . Click **Finish**.

The **Monitor Resource Definitions** list should look similar to the following. When the mirror disk resource is used, mdnw1 and mdw1 are additionally displayed.:

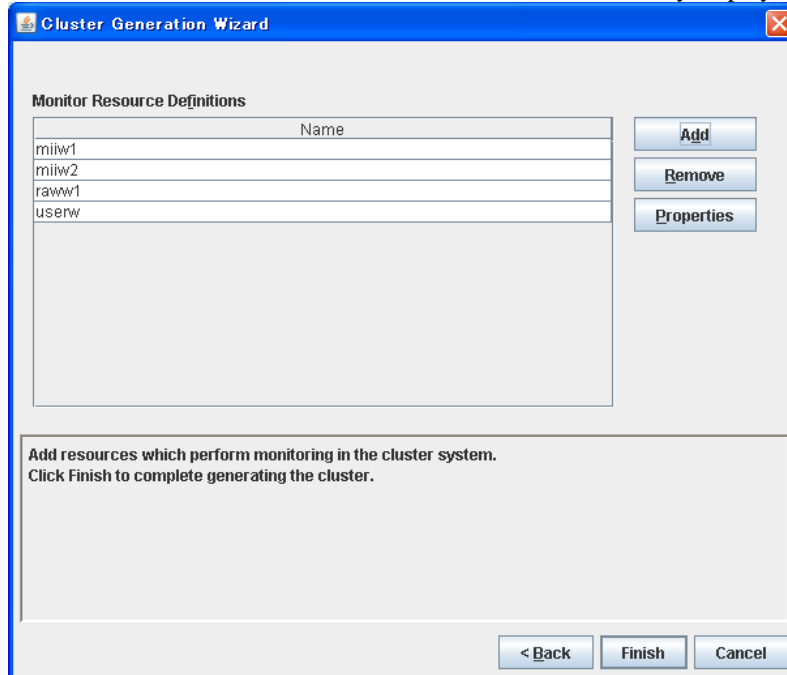

8. Click **Finish**.

Creating the cluster configuration data is completed. Proceed to “Creating a cluster” on page 154.

Checking the values to be configured in the cluster environment with 3 nodes

Sample cluster environment

As shown in the diagram below, this chapter uses a configuration with three nodes mirror as a cluster example.

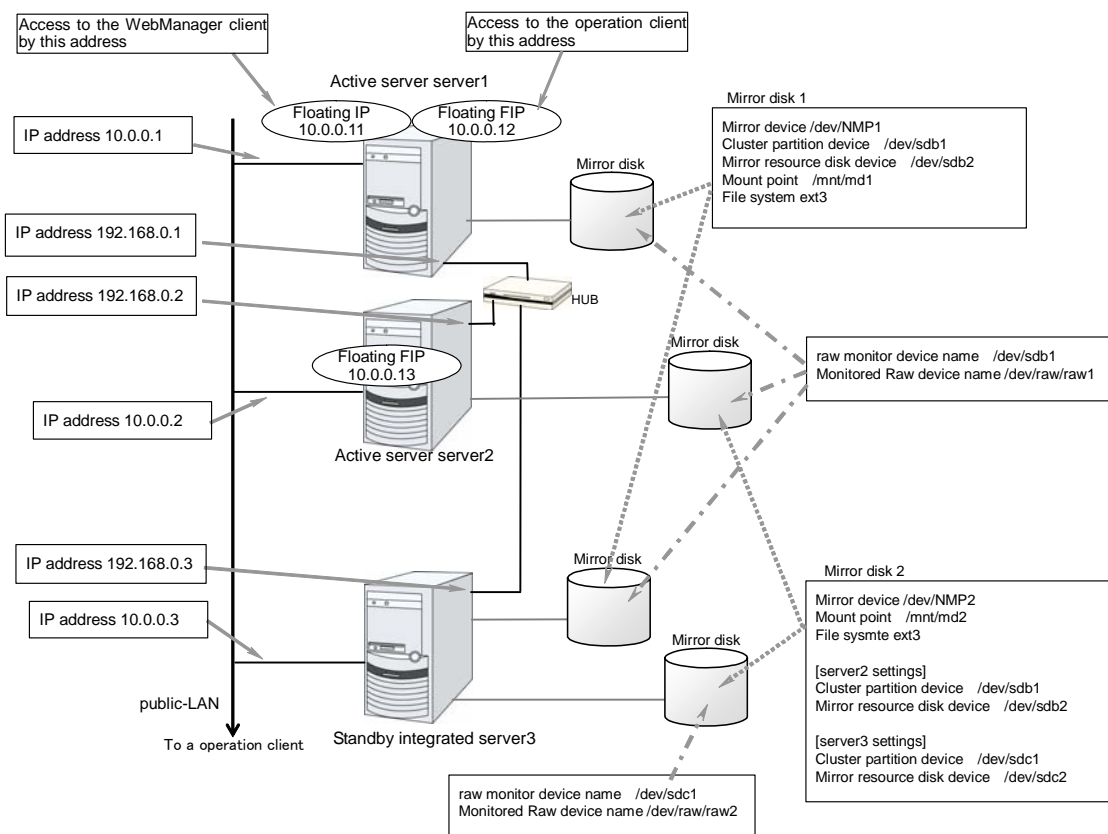

The following table lists sample values of the cluster configuration data to achieve the cluster system shown above. These values and configuration are applied hereafter in the step-by-step instruction to create the cluster configuration data. When you actually set the values, you may need to modify them according to the cluster you are intending to create. For information on how you determine the values, refer to the *Referenced Guide*.

Example of configuration with 3 nodes

Target	Parameter	Value
Cluster configuration	Cluster name	cluster
	Number of servers	3
	Number of failover groups	3
	Number of monitor resources	10
Heartbeat resources	Number of LAN heartbeats	2
	Number of kernel mode LAN heartbeats	2

Target	Parameter	Value
First server information (Master server)	Server name*1	server1
	Interconnect IP address (Dedicated)	192.168.0.1
	Interconnect IP address (Backup)	10.0.0.1
	Public IP address	10.0.0.1
	Mirror disk connect 1	192.168.0.1
	Mirror disk connect 2	-
Second server information	Server name*1	server2
	Interconnect IP address (Dedicated)	192.168.0.21
	Interconnect IP address (Backup)	10.0.0.2
	Public IP address	10.0.0.2
	Mirror disk connect 1	-
	Mirror disk connect 2	192.168.0.2
Third server information (Standby integrated server)	Server name*1	server3
	Interconnect IP address (Dedicated)	192.168.0.3
	Interconnect IP address (Backup)	10.0.0.3
	Public IP address	10.0.0.3
	Mirror disk connect 1	192.168.0.3
	Mirror disk connect 2	192.168.0.3
Group resources for management (For the WebManager)	Type	failover
	Group name	ManagementGroup
	Startup server	All servers
	Number of group resources	1
Group resources for management *2	Type	floating IP resource
	Group resource name	ManagementIP
	IP address	10.0.0.11
Group resources for operation 1	Type	failover
	Group name	failover1
	Startup server	server1 -> server3
	Number of group resources	3
First group resources	Type	floating IP resource
	Group resource name	fip1
	IP address	10.0.0.12
Second group	Type	mirror disk resource

Target	Parameter	Value
resources	Group resource name	md1
	Mirror partition device name	/dev/NMP1
	Mount point	/mnt/md1
	Data partition device name	/dev/sdb2
	Cluster partition device name	/dev/sdb1
	Disk device name	/dev/sdb
	File system	ext3
	Mirror disk connect	mdc1
Third group resources	Type	exec resource
	Group resource name	exec1
	Script	Standard Script
Group resources for operation 2	Type	failover
	Group name	failover3
	Startup server	server2 -> server3
	Number of group resources	3
First group resources	Type	floating IP resource
	Group resource name	fip2
	IP address	10.0.0.13
Second group resources	Type	mirror disk resource
	Group resource name	Md2
	Mirror partition device name	/dev/NMP2
	Mount point	/mnt/md2
	Data partition device name (server3 individual server setting)	/dev/sdc2
	Cluster partition device name	/dev/sdb1
	Cluster partition device name (server3 individual server setting)	/dev/sdc1
	Disk device name	/dev/sdb
	Disk device name (server3 individual server setting)	/dev/sdc
	File system	ext3
	Mirror disk connect	mdc2
Third group resources	Type	execute resource
	Group resource name	exec2
	Script	Standard script
First monitor resources (Created by default)	Type	
	Monitor resource name	userw

Target	Parameter	Value
Second monitor resources	Type	raw monitor
	Monitor resource name	raww1
	Device name	/dev/sdb1
	Monitored target raw device name	/dev/raw/raw1
	When error is detected	Stop the cluster daemon and shut down OS
Third monitor resources	Type	raw monitor
	Monitor resource name	raww2
	Device name	/dev/sdc1
	Monitored raw device name	/dev/raw/raw2
	When error is detected	Stop the cluster daemon and shut down OS
	Startup server	server3
Fourth monitor resources	Type	NIC Link Up/Down monitor
	Monitor resource name	miiw1
	Monitored target	eth0 (Interface of public)
	When error is detected	"ManagementGroup" group's Failover *3
Fifth monitor resource	Type	NIC Link Up/Down monitor
	Monitor resource name	miiw2
	Monitored target	eth0 (Interface of public)
	When error is detected	"failover1" group's Failover *3
Sixth monitor resource	Type	NIC Link Up/Down monitor
	Monitor resource name	miiw3
	Monitored target	eth0 (Interface of public)
	When error is detected	"failover2" group's Failover *3
Seventh monitor resource (Automatically created after creating mirror disk resource)	Type	mirror disk connect monitor
	Monitor resource name	mdnw1
	Monitored mirror disk resource	md1
	When error is detected	No operation
Eighth monitor resource (Automatically created after creating mirror disk resource)	Type	mirror disk connect monitor
	Monitor resource name	mdnw2
	Monitored mirror disk resource	md2
	When error is detected	No operation
Ninth monitor	Type	mirror disk monitor

Target	Parameter	Value
resource (Automatically created after creating mirror disk resource)	Monitor resource name	mdw1
	Monitored mirror disk resource	md1
	When error is detected	No operation
Tenth monitor resource (Automatically created after creating mirror disk resource)	Type	mirror disk monitor
	Monitor resource name	mdw2
	Monitored mirror disk resource	md2
	When error is detected	No operation

*1: “Host name” represents the short name that excludes the domain name from a frequently qualified domain name (FQDN).

*2: You should have a floating IP address to access the WebManager. You can access the WebManager from your Web browser with a floating IP address when an error occurs.

*3: For the settings to execute a failover when all interconnect LANs are disconnected, see Chapter 6, “Monitor resource details” in the *Reference Guide*.

Creating the configuration data of a 3-nodes cluster

Creating the cluster configuration data involves creating a cluster, group resources, and monitor resources. The steps you need to take to create the data are described in this section.

Note:

The following instruction can be repeated as many times as necessary. Most of the settings can be modified later by using the rename function or properties view function.

1. Create a cluster

Add a cluster you want to construct and enter its name.

1-1. Add a cluster

Add a cluster you want to construct and enter its name.

1-2. Add the first server

Add a server. Make settings such as IP addresses.

1-3. Add the second server

Add a server. Make settings such as IP addresses.

1-4. Add the third server

Add a server. Make settings such as IP addresses.

2. Create a failover group

Create a failover group that works as a unit when a failover occurs.

2-1. Add a group for management

Add a group that works as a unit when a failover occurs.

2-2. Add a group 1 (failover1) for operation

Add a resource that constitutes a group.

2-3. Add a group resource (floating IP address)

Add a resource that constitutes a group.

2-4. Add a group resource (mirror disk resource)

Add a resource that constitutes a group.

2-5. Add a group resource (EXEC resource)

Add a resource that constitutes a group.

2-6. Add a group 2 (failover2) for operation

Add a resource that constitutes a group.

2-7. Add a group resource (floating IP address)

Add a resource that constitutes a group.

2-8. Add a group resource (mirror disk resource)

Add a resource that constitutes a group.

2-9. Add a group resource (EXEC resource)

Add a resource that constitutes a group.

3. Create monitor resources

Create a monitor resource that monitors specified target in a cluster.

3-1. Add a monitor resource (raw monitor resource)

Add a monitor resource to use.

3-2. Add a monitor resource (raw monitor resource)

Add a monitor resource to use.

3-3. Add a monitor resource (NIC Link Up/Down monitor resource for management group)

Add a monitor resource to use.

3-4. Add a monitor resource (NIC Link Up/Down monitor resource for application group (failover1))

Add a monitor resource to use.

3-5. Add a monitor resource (NIC Link Up/Down monitor resource for application group (failover2))

Add a monitor resource to use.

1. Creating a cluster

Create a cluster. Add a server that constitute a cluster and determine a heartbeat priority.

1-1. Add a cluster

1. On the **File** menu of the Builder, click **Cluster Generation Wizard**. The **Cluster Generation Wizard** is displayed. In the **Language** field, select a language that is used on the machine that the WebManager works.

Note:

On the WebManager, only one language is available within one cluster. If multiple languages are used within a cluster, specify English to avoid garbled characters.

2. In the **Cluster Definition** dialog box, type the cluster name (cluster) in the **Name** box, and then click **Next**.

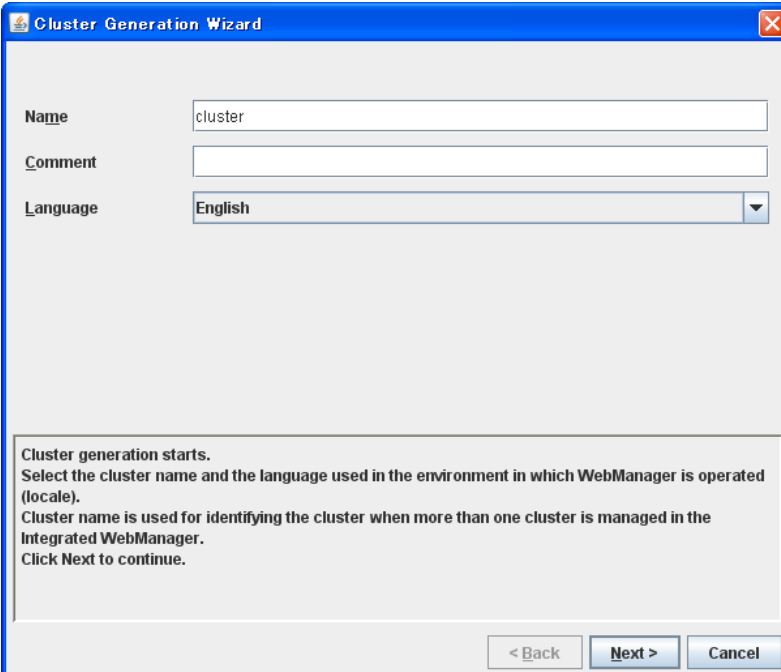

The screenshot shows a dialog box titled "Cluster Generation Wizard". It has three input fields: "Name" with the text "cluster", "Comment" which is empty, and "Language" which is a dropdown menu set to "English". Below the fields is a text area containing instructions: "Cluster generation starts. Select the cluster name and the language used in the environment in which WebManager is operated (locale). Cluster name is used for identifying the cluster when more than one cluster is managed in the Integrated WebManager. Click Next to continue." At the bottom right, there are three buttons: "< Back", "Next >" (which is highlighted), and "Cancel".

1-2. Add the first server

Add information of each server that constitutes a cluster.

1. The **Server Definitions** list is displayed.

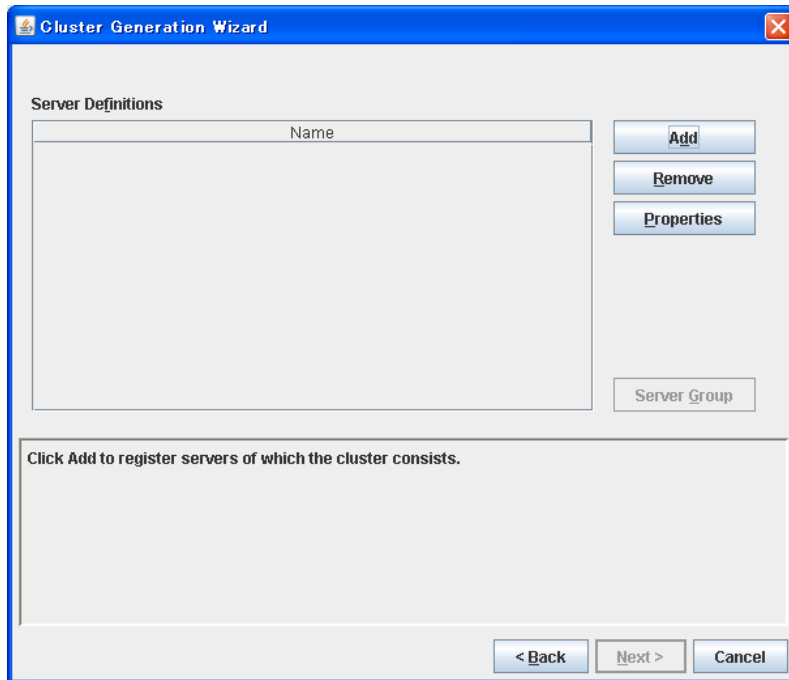

2. In the **Server Definitions** list, click **Add**.
3. In the **Server Definition** dialog box is displayed. Enter the data of the first server. Enter the server name (**server1**) in the **Name** box, and then click **Next**.

Note:

Enter the actual host name of the server. Make sure to type it correctly because the information you enter here is case sensitive.

4. Set up an interconnect LAN. Click **Add** and enter the interconnect IP address (dedicated) **192.168.0.1** in the **IP Address** box. Click **OK**.
5. The IP address you have entered is displayed in **Interconnect LAN I/F**. Enter the interconnect LAN IP address (backup) **10.0.0.1**. Click **Next**.
6. Click **Add** and enter the IP address of the public LAN **10.0.0.1** in the **IP Address** box. Click **OK**.
7. The IP address you have entered is set in **Public LAN I/F**. Click **Next**.
8. The COM heartbeat device setting window is displayed. Click **Next**.
9. The disk heartbeat device setting window is displayed. Click **Next**.
10. **Ping I/F** is displayed. Click **Next**.
11. Click **Add** and enter mirror disk connect **192.168.0.1** in the **IP address** box. Click **OK**.
12. Click **Add** and click **OK** without entering anything in the **IP address** box. Nothing is entered because server1 does not use [2] of **I/F No**.
13. The address you entered is listed in **Mirror Disk Connect I/F**. Check 192.168.0.1 is configured in [1] of **I/F No** while nothing is set in [2] of **I/F No**. Click **Finish**.

The **Server Definitions** should look similar to the following. The server defined first becomes the master server by default.

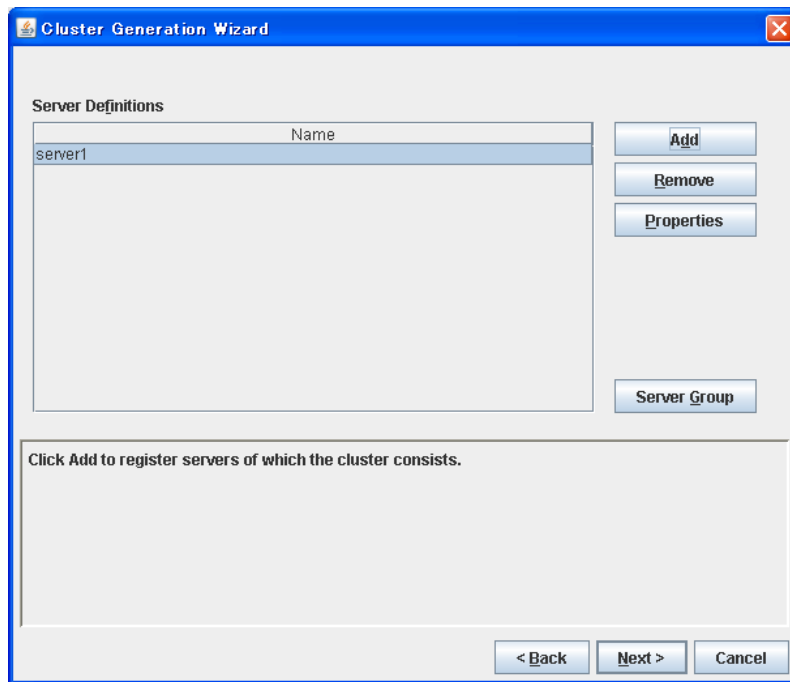

1-3. Add the second server

Enter the second server information after the first server information.

1. In the **Server Definitions** list, click **Add**.
2. In the **Server Definition** dialog box, enter the data of the second server. Enter the server name **server2** in the **Name** box, and then click **Next**. Enter the actual host name of the server. The information you enter here is case sensitive.
3. When you define the second server and rest of servers, you will see I/Fs in definition as many as you find in the master server. The IP address is blank by default. Set the IP address corresponding to the I/F number registered in other servers. Click **Edit** and enter the interconnect LAN IP address (dedicated) **192.168.0.2** in the **IP Address** box. Click **OK**.
4. The IP address you have entered is set in **Interconnect LAN I/F**. Likewise, select **[2]** of **I/F No.**, click **Edit**, and enter the LAN IP address (Backup) **10.0.0.2**. Click **Next**.
5. Click **Edit** and enter the public IP address **10.0.0.2** in the **IP Address** box. Click **OK**.
6. Check to see the IP address you have entered in the **Public LAN I/F** is set. Click **Next**.
7. Nothing needs to be configured in the COM heartbeat device settings window. Click **Next**.
8. Nothing needs to be configured in the disk heartbeat device settings window. Click **Next**.
9. Nothing needs to be configured in **Ping I/F**. Click **Next**.
10. In server definition after the second server, the same number of I/F as the master server I/F is displayed. Configure an IP address corresponding to I/F number registered to other servers. Select **[2]** of **I/F No.**, click **Edit**, and enter the mirror disk connect **192.168.0.2** in **IP Address**. Click **OK**. Verify that the IP address entered is registered to **Mirror Disk Connect I/F**. Confirm that **192.168.0.2** is set to **[2]** of **I/F No.** and nothing is set to **[1]**. Click **Finish**.

The **Server Definitions** list should look similar to the following.

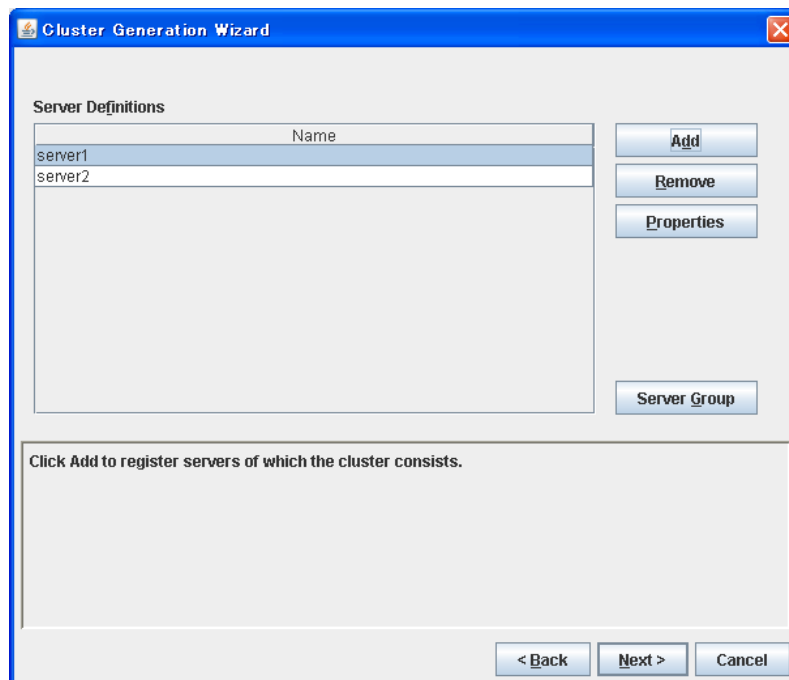

1-4. Add the third server

Enter the third server information corresponding to the information of first and second servers.

1. In the **Server Definitions** list, click **Add**.
2. In the **Server Definition** dialog box, enter the data of the second server. Enter the server name **server3** in the **Name** box, and then click **Next**. Enter the actual host name of the server. The information you enter here is case sensitive.
3. When you define the second server and rest of servers, you will see I/Fs in definition as many as you find in the master server. The IP address is blank by default. Set the IP address corresponding to the I/F number registered in other servers. Click **Edit** and enter the interconnect LAN IP address (dedicated) **192.168.0.3** in the **IP Address** box. Click **OK**.
4. The IP address you have entered is set in **Interconnect LAN I/F**. Likewise, select **[2]** of **I/F No.**, click **Edit**, and enter the LAN IP address (Backup) **10.0.0.3**. Click **Next**.
5. Click **Edit** and enter the public IP address **10.0.0.3** in the **IP Address** box. Click **OK**.
6. Check to see the IP address you have entered in the **Public LAN I/F** is set. Click **Next**.
7. Nothing needs to be configured in the COM heartbeat device settings window. Click **Next**.
8. Nothing needs to be configured in the disk heartbeat device settings window. Click **Next**.
9. Nothing needs to be configured in **Ping I/F**. Click **Next**.
10. In server definition after the second server, the same number of I/F as the master server I/F is displayed. Configure an IP address corresponding to I/F number registered to other servers. Select **[1]** of **I/F No.**, click **Edit**, and enter the mirror disk connect **192.168.0.3** in **IP Address**. Likewise, select **[2]** of **I/F No.**, click **Edit**, and enter the mirror disk connect **192.168.0.3** in **IP Address**. Click **OK**. Verify that the IP address entered is registered to **Mirror Disk Connect I/F**. Confirm that **192.168.0.2** is set to **[2]** of **I/F No.** and nothing is set to **[1]**. Click **Next**. Click **OK**. Verify that the IP address entered is registered to **Mirror Disk Connect I/F**. Confirm that **192.168.0.3** is set to **[1]** and **[2]** of **I/F No.**
11. Click **Finish**.

The **Server Definitions** list should look similar to the following.

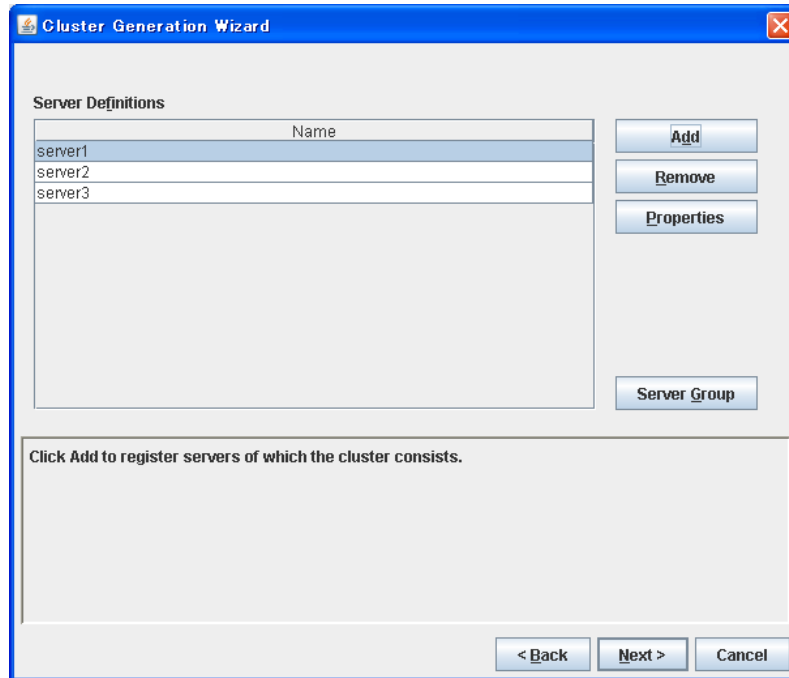

2. Creating a failover group

Add a failover group to the cluster. First, create a failover group for management and then add a failover group that executes an application.

2-1. Add a group for management

When you add a group to a failover group, first create a group for the WebManager. This group uses a floating IP and accesses servers in the cluster from a management PC. This allows access from the WebManager to a server that has failed over even if one of the servers goes down and failover occurs.

1. Click **Next** on the **Server Definition**.
2. The **Group Definitions** list is displayed.

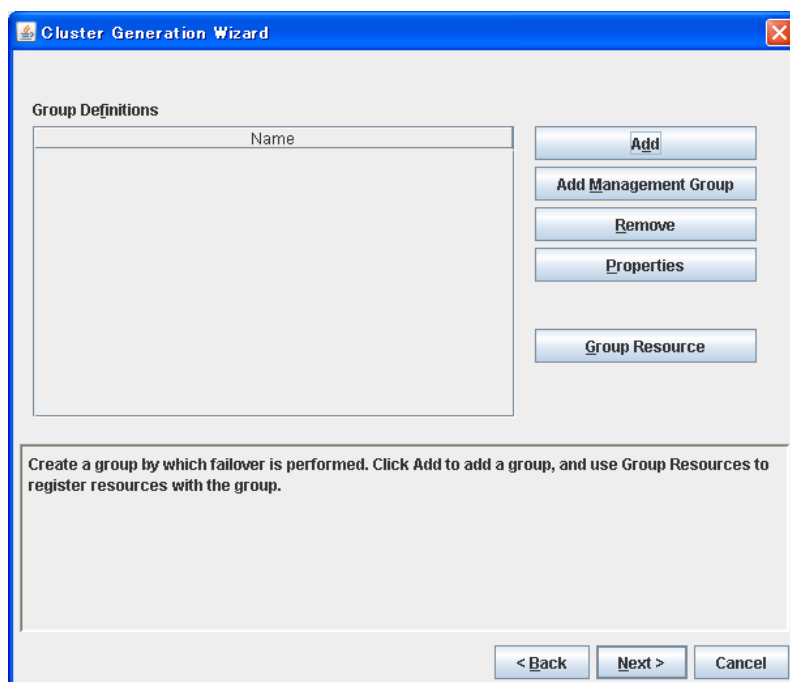

3. Click **Add Management Group**. **ManagementGroup** is added and displayed in the **Group Definitions** list.
4. Click **Group Resource** with **ManagementGroup** selected. **Group Resource Definitions** is displayed. Click **Add**.
5. In the **Type** box, select the group resource type (**floating ip resource**). In the **Name** box, the default name (**ManagementIP**) is entered. Click **Next**.
6. Enter the floating IP address (10.0.0.11) in the **IP Address** box, and then click **Next**.
7. **Recovery Operation at Activation Failure Detection** and **Recovery Operation at Deactivation Failure Detection** are displayed. Click **Next**.
8. A page for setting up a dependency is displayed. Click **Finish**.

9. **Group Resource Definitions** is displayed. Confirm that the Management IP is registered, and then click **Close**.

A group for management is added. The **Cluster Generation Wizard** should look similar to the following:

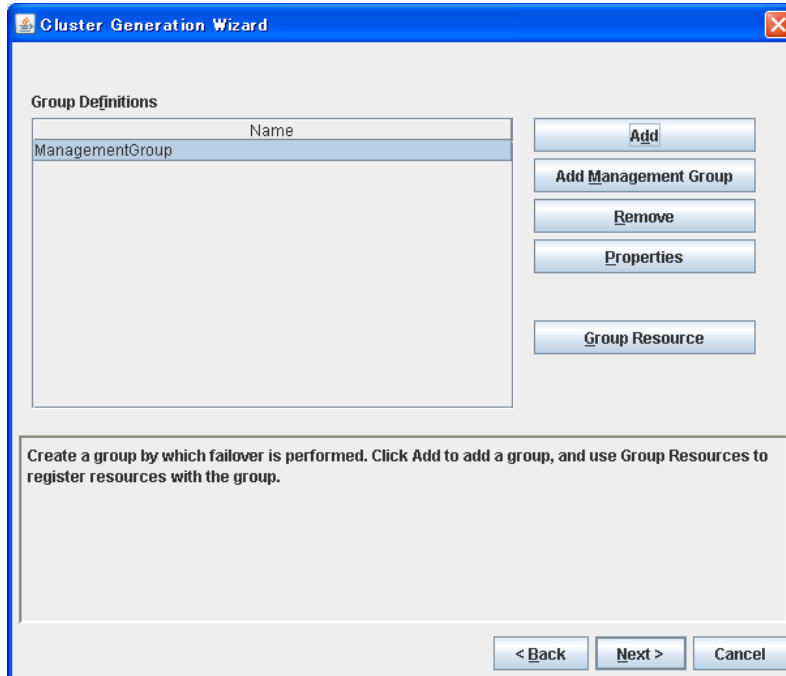

2-2. Add a group for operation

Set up a group that works as a unit of failover at the time an error occurs.

1. In the **Group Definitions** list, click **Add**.
2. In the **Group Definition** dialog box, enter the group name (**failover1**) in the **Name** box, and click **Next**.
3. Clear the **Failover is possible at all servers** check box.
4. Select **server1** on **Available Servers** and click **Add**. **server1** is added to **Servers that can run the Group**. Likewise, add **server3** and then click **Finish**.

A failover group is added. The **Group Definitions** list should look similar to the following:

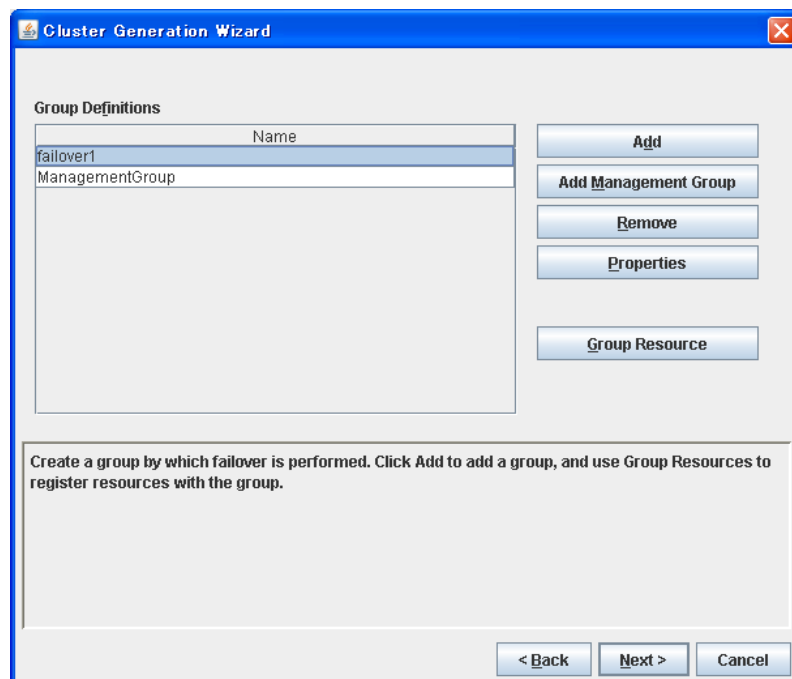

2-3. Add a group resource (floating IP address)

Add a group resource, a configuration element of the group, to the failover group you have created in Step 2-2.

1. In the **Group Definitions** list, click **Group Resource** with **failover1** selected.
2. Click **Add** in the **Group Resource Definitions** list.
3. In the **Resource Definition** dialog box, select the group resource type **floating ip resource** in the **Type** box, and enter the group name **fip1** in the **Name** box. Click **Next**.
4. Enter the IP Address **10.0.0.12** in the **IP Address** box. Click **Next**.
5. **Recovery Operation at Activation Failure Detection** and **Recovery Operation at Deactivation Failure Detection** are displayed. Click **Next**.
6. A page for setting up a dependency is displayed. Click **Finish**.

2-4. Add a group resource (mirror disk resource)

1. In the **Group Resource Definitions list**, click **Add**.
2. In the **Resource Definition** dialog box, select the group resource type **mirror disk resource** in the **Type** box, and enter the group resource name **md1** in the **Name** box. Click **Next**.
3. Select the mirror partition device name **/dev/NMP1** in the **Mirror Partition Device Name** box. Enter the mount point **/mnt/md1**, the data partition device name **/dev/sdb2**, the cluster partition device name **/dev/sdb1**, and the disk device name **/dev/sdb** in the respective box. In the **File System** dialog box, select the file system **ext3**.
4. Click **Select** in **Mirror Disk Connect**. Select **[2]** of **I/F No.** and click **Remove**. Confirm that only **[1]** of **I/F No.** is selected in the **Mirror Disk Connects** list. Click **OK**.
5. In **Resource Definition**, click **Next**.
6. **Recovery Operation at Activation Failure Detection** and **Recovery Operation at Deactivation Failure Detection** are displayed. Click **Next**.
7. A page for setting up a dependency is displayed. Click **Finish**.

2-5. Add a group resource (exec resource)

Add an exec resource that can start and stop the application from a script.

1. In the **Group Resource Definitions list**, click **Add**.
2. In the **Resource Definition** dialog box, select the group resource **execute resource** in the **Type** box, and enter the group name **exec1** in the **Name** box. Click **Next**.
3. Select **Script created with this product**. Edit the script if applications to be used in ExpressCluster are already decided. Users may edit this script to describe the procedure to start and stop a group of applications. Click **Next**.
4. **Recovery Operation at Activation Failure Detection** and **Recovery Operation at Deactivation Failure Detection** are displayed. Click **Next**.
5. A page for setting up a dependency is displayed. Click **Finish**.

The **Group Resource Definitions** list of the **failover1** should look similar to the following:

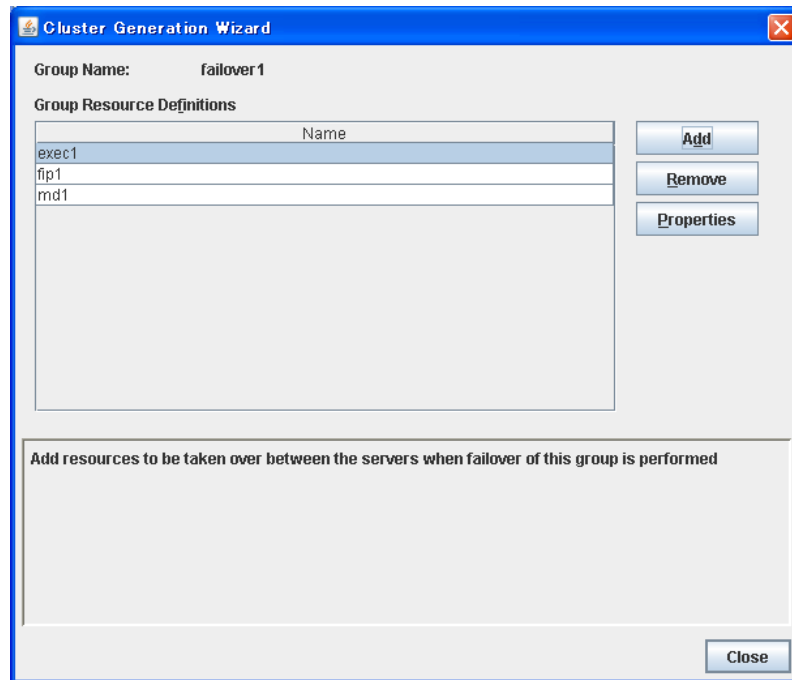

6. Click **Close**.

2-6 Add a group for operation 2

Set up a group that works as a unit of failover at the time an error occurs.

1. In the **Group Definitions** list, click **Add**.
2. In the **Group Definition** dialog box, enter the group name (**failover2**) in the **Name** box, and click **Next**.
3. Clear the **Failover is possible at all servers** check box.

4. Select **server2** on **Available Servers** and click **Add**. **server2** is added to **Servers that can run the Group**. Likewise, add **server3**.

A failover group is added. The **Group Definitions** list should look similar to the following:

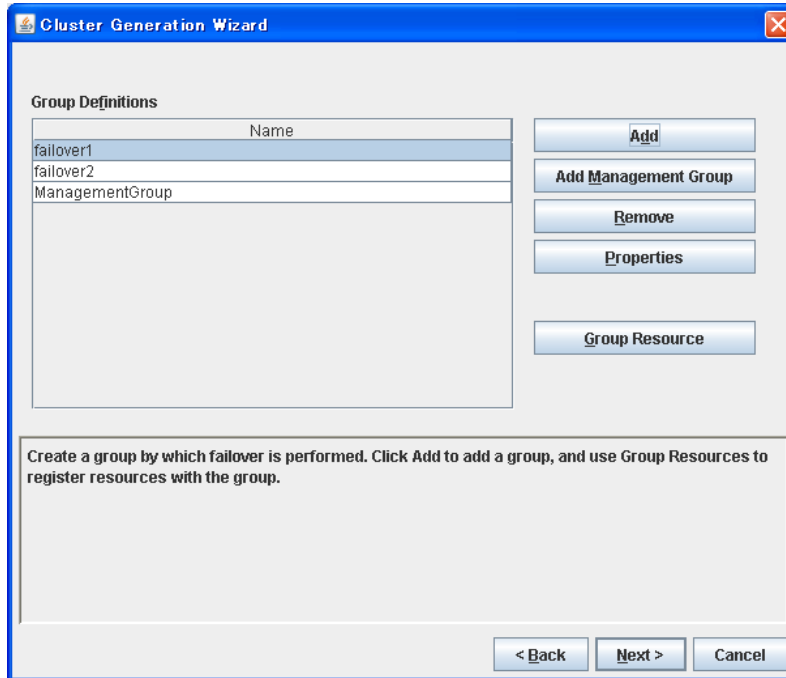

2-7. Add a group resource (floating IP address)

Add a group resource, a configuration element of the group, to the failover group you have created in Step 2-6.

1. In the **Group Definitions** list, click **Group Resource** with **failover2** selected.
2. Click **Add** in the **Group Resource Definitions** list.
3. In the **Resource Definition** dialog box, select the group resource type **floating ip resource** in the **Type** box, and enter the group name **fip2** in the **Name** box. Click **Next**.
4. Enter the IP Address **10.0.0.13** in the **IP Address** box. Click **Next**.
5. **Recovery Operation at Activation Failure Detection** and **Recovery Operation at Deactivation Failure Detection** are displayed. Click **Next**.
6. A page for setting up a dependency is displayed. Click **Finish**.

2-8. Add a group resource (mirror disk resource)

1. Click **Add** in the **Group Resource Definitions** list.
2. In the **Resource Definition** dialog box, select the group resource type **mirror disk resource** in the **Type** box, and enter the group name **md2** in the **Name** box. Click **Next**.
3. Select the mirror partition device name **/dev/NMP2** in **Mirror Partition Device Name** box. Enter the mount point **/mnt/md2**, the data partition device name **/dev/sdb2**, the cluster partition device name **/dev/sdb1**, and the disk device name **/dev/sdb** in the respective box. In the **File System** dialog box, select the file system **ext3**.
4. Click **Select** in **Mirror Disk Connect**. Select **[1]** of **I/F No.** and click **Remove**. Confirm that only **[2]** of **I/F No.** is selected in the **Mirror Disk Connects** list. Click **OK**.
5. Click the **server3** tab in the **Resource Definition** dialog box and select the **Set Up Individually** check box. Enter the data partition device name (**/dev/sdc2**), cluster partition device name (**/dev/sdc1**) and disk device name (**/dev/sdc**).
6. In **Resource Definition**, click **Next**.
7. **Recovery Operation at Activation Failure Detection** and **Recovery Operation at Deactivation Failure Detection** are displayed. Click **Next**.
8. A page for setting up a dependency is displayed. Click **Finish**.

2-9. Add a group resource (exec resource)

Add an exec resource that can start and stop the application from a script.

1. Click **Add** in the **Group Resource Definitions** list.
2. In the **Resource Definition** dialog box, select the group resource **execute resource** in the **Type** box, and enter the group name **exec2** in the **Name** box. Click **Next**.
3. Select **Script created with this product**. Edit the script if applications to be used in ExpressCluster are already decided. Users may edit this script to describe the procedure to start and stop a group of applications. Click **Next**.
4. **Recovery Operation at Activation Failure Detection** and **Recovery Operation at Deactivation Failure Detection** are displayed. Click **Next**.

5. A page for setting up a dependency is displayed. Click **Finish**. When a cluster system is a data mirror type, the **Group Resource Definitions** list of the **failover2** should look similar to the following:

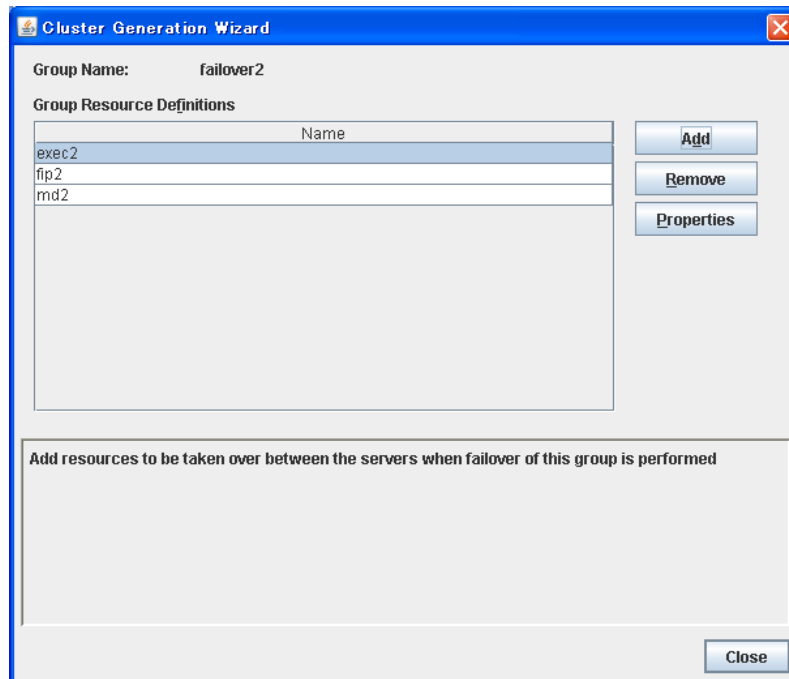

6. Click **Close**.

3. Creating monitor resources

Add a monitor resource that monitors a specified target to the cluster.

3.1 Add a monitor resource (raw monitor resource)

Add monitor resources to monitor the target disk. Raw monitor is used as an example of a monitor resource to be added.

1. In the **Group Definitions** list, click **Next**.
2. In the **Monitor Resource Definitions** list, click **Add**.
3. In the **Monitor Resource Definition** dialog box, the first monitor resource information is created by default when the cluster name is defined. The monitor resource information from seventh to tenth is created by default when mirror disk resource is added. Select the monitor resource type **raw monitor** in the **Type** box, and enter the monitor resource name **raww1** in the **Name** box. Click **Next**.
4. Enter the target monitor disk and raw device name (**/dev/raw/raw1**). Enter the device name (**/dev/sdb1**) in **Device Name**. Click **Next**.
5. Configure the monitor settings. Do not change the default value and click **Next**.
6. Specify the recovery target. Click **Browse**.
7. Click **cluster** in the tree view shown. Click **OK**.
8. Select **Stop the cluster daemon and shut down OS** in the **Final Action** box, and click **Finish**.

3.2 Add a monitor resource (raw monitor resource)

Add monitor resources to monitor the target disk. Raw monitor is used as an example of a monitor resource to be added.

1. In the **Monitor Resource Definitions** list, click **Add**.
2. In the **Monitor Resource Definition** dialog box, the first monitor resource information is created by default when the cluster name is defined. Select the monitor resource type **raw monitor** in the **Type** box, and enter the monitor resource name **raww2** in the **Name** box. Click **Next**.
3. Enter the target monitor disk and raw device name (**/dev/raw/raw2**). Enter the device name (**/dev/sdc1**) in **Device Name**. Click **Next**.
4. Configure the monitor settings. Click **Server**.
5. Select the **Select** check box. Select **server3** on **Available Servers**. Confirm that server3 is added to **Servers that can run the Group**. Click **OK**.
6. In the **Monitor Resource Definition** window, click **Next**.
7. Specify the recovery target. Click **Browse**.
8. Click **cluster** in the tree view shown. Click **OK**.
9. Select **Stop the cluster daemon and shut down OS** in the **Final Action** box, and click **Finish**.

3-3. Add a monitor resource (NIC Link Up/Down monitor resource for management group)

Add monitor resources that monitor NIC. NIC Link Up/Down monitor needs to be created on a failover group basis. Because the example used here has two groups, a group for management and a group for an application. A NIC Link Up/Down monitor is created for each group.

1. In the **Monitor Resource Definitions** list, click **Next**.
2. In the **Monitor Resource Definition** dialog box, select the monitor resource type **NIC Link Up/Down monitor** in the **Type** box, and enter the monitor resource name **miiw1** in the **Name** box. Click **Next**.
3. Enter the NIC (eth0) to be monitored in the **Monitor Target** box, and click **Next**.
4. Configure the monitor settings. Do not change the default value. Click **Next**.
5. Specify the recovery target. Click **Browse**.
6. Click **ManagementGroup** in the tree view and click **OK**. “ManagementGroup” is set in the **Recovery Target**.
7. Set **0** in the **Reactivation Threshold** box, and set **1** in the **Failover Threshold**. . Click **Finish**.

3-4. Add a monitor resource (NIC Link Up/Down monitor resource for operation 1)

1. In the Monitor Resource Definitions list, click Next.
2. In the **Monitor Resource Definition** dialog box, select the monitor resource type **NIC Link Up/Down monitor** in the **Type** box, and enter the monitor resource name **miiw2** in the **Name** box. Click **Next**.
3. Enter the NIC (eth0) to be monitored in the **Monitor Target** box, and click **Next**.
4. Configure the monitor settings. Click **Next**.
5. Specify the recovery target. Click **Browse**.
6. Click **failover1** in the tree view. Click **OK**. “failover1” is set in the **Recovery Target**.
7. Set **0** in the **Reactivation Threshold** box, and set **1** in the **Failover Threshold**.. Click **Finish**.

3-5. Add a monitor resource (NIC Link Up/Down monitor resource for operation 2)

1. In the **Monitor Resource Definitions** list, click **Add**.
2. In the **Monitor Resource Definition** dialog box, select the monitor resource type **NIC Link Up/Down monitor** in the **Type** box, and enter the monitor resource name **miiw3** in the **Name** box. Click **Next**.
3. Enter the NIC (eth0) to be monitored in the **Monitor Target** box, and click **Next**.
4. Specify the monitor settings. Do not change the default value. Click **Next**.
5. Configure the recovery target. Click **Browse**.
6. Click **failover2** in the tree view. Click **OK**. “failover2” is set in the **Recovery Target**.
7. Set **0** in the **Reactivation Threshold** box, and set **1** in the **Failover Threshold**. . Click **Finish**.

The **Monitor Resource Definitions** list should look similar to the following:

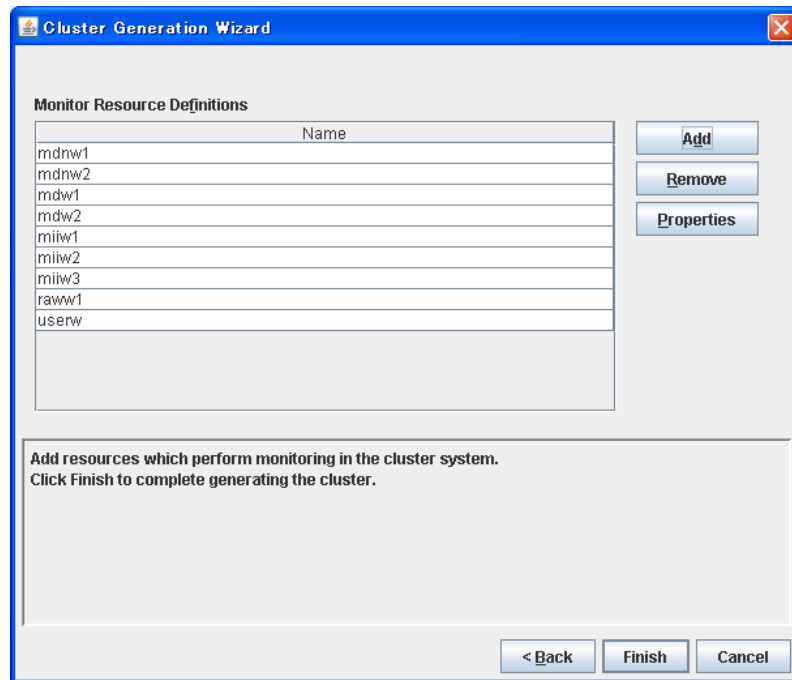

8. Click **Finish**.

Creating the cluster configuration data is completed. Proceed to "Creating a cluster" on page 154.

Checking the values to be configured in the cluster environment with 3 nodes (hybrid type)

Sample cluster environment

As shown in the diagram below, this chapter uses a configuration with three nodes hybrid type as a cluster example.

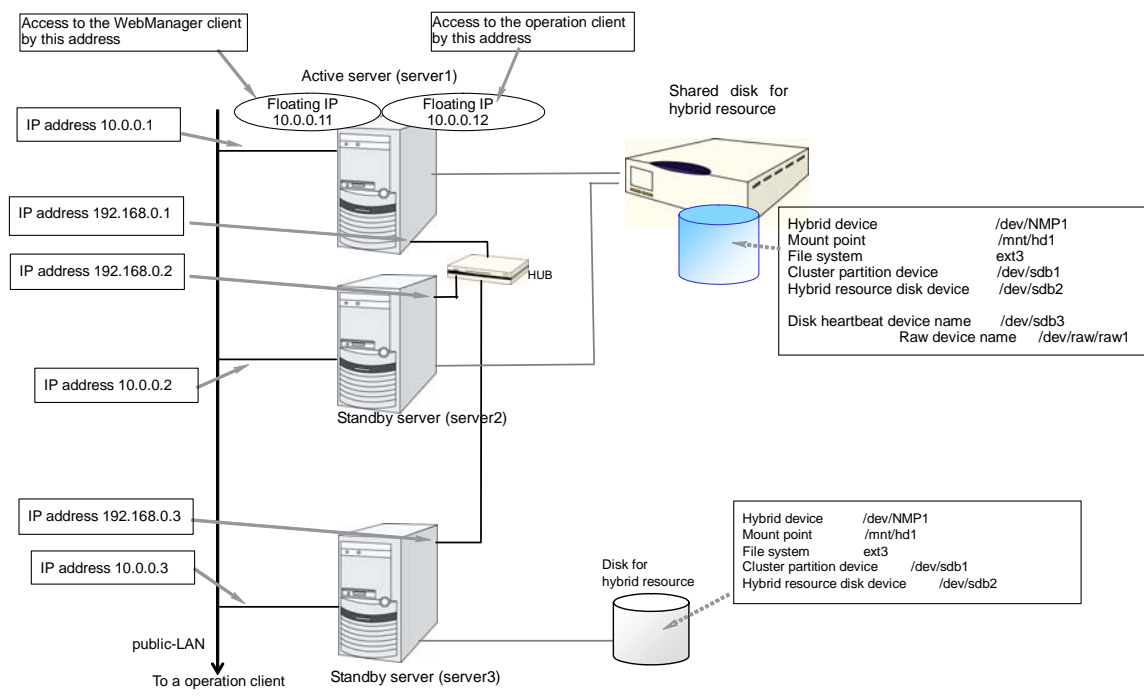

The following table lists sample values of the cluster configuration data to achieve the cluster system shown above. These values and configuration are applied hereafter in the step-by-step instruction to create the cluster configuration data. When you actually set the values, you may need to modify them according to the cluster you are intending to create. For information on how you determine the values, refer to the *Referenced Guide*.

Example of configuration with 3 nodes

Target	Parameter	Value
Cluster configuration	Cluster name	cluster
	Number of servers	3
	Number of failover groups	2
	Number of server groups	2
	Number of monitor resources	6
	Server Down Notification	Off (not used)
Heartbeat resources	Number of LAN heartbeats	2
	Number of kernel mode LAN	2

Target	Parameter	Value
	heartbeats	
	Number of disk heartbeats	1
First server information (Master server)	Server name	server1
	Interconnect IP address (Dedicated)	192.168.0.1
	Interconnect IP address (Backup)	10.0.0.1
	Public IP address	10.0.0.1
	Disk heartbeat device	/dev/sdb3
	Disk heartbeat Raw device	/dev/raw/raw1
	Mirror disk connect 1	192.168.0.1
	Mirror disk connect 2	-
Second server information	Server name	server2
	Interconnect IP address (Dedicated)	192.168.0.2
	Interconnect IP address (Backup)	10.0.0.2
	Public IP address	10.0.0.2
	Disk heartbeat device	/dev/sdb3
	Disk heartbeat Raw device	/dev/raw/raw1
	Mirror disk connect	192.168.0.2
Third server information	Server name	server3
	Interconnect IP address (Dedicated)	192.168.0.3
	Interconnect IP address (Backup)	10.0.0.3
	Public IP address	10.0.0.3
	Disk heartbeat device	Not configured
	Disk heartbeat Raw device	Not configured
	Mirror disk connect	192.168.0.3
First server group	Server group name	svg1
	Belonging servers	server1 server2
Second server group	Server group name	svg2
	Belonging servers	server3
Group for management (For the WebManager)	Type	failover
	Group name	ManagementGroup
	Startup server	All servers
	Number of group resources	1
Group resources	Type	floating IP resource

Target	Parameter	Value
for management	Group resource name	ManagementIP
	IP address	10.0.0.11
Group resources for operation	Type	failover
	Group name	failover1
	Startup server	server1 -> server 2 -> server3
	Server Group	svg1 -> svg2
	Number of group resources	3
First group resources	Type	floating IP resource
	Group resource name	fip1
	IP address	10.0.0.12
Second group resources	Type	hybrid disk resource
	Group resource name	hd1
	Mirror partition device name	/dev/NMP1
	Mount point	/mnt/hd1
	Data partition device name	/dev/sdb2
	Cluster partition device name	/dev/sdb1
	Disk device name	/dev/sdb
	File system	ext3
	Mirror disk connect	mdc1
Third group resources	Type	execute resource
	Group resource name	exec1
	Script	Standard Script
First monitor resources (Created by default)	Type	usew
	Monitor resource name	userw
Second monitor resources	Type	diskw
	Monitor resource name	diskw1
	Monitored target	/dev/sdb2/
	Monitoring method	READ(O_DIRECT)
	When error is detected	Stop the cluster daemon and shut down OS
Third monitor resources	Type	NIC Link Up/Down monitor
	Monitor resource name	miiw1
	Monitored target	eth0 (Interface of public)
	When error is detected	"ManagementGroup" group's Failover
Fourth monitor resources	Type	NIC Link Up/Down monitor
	Monitor resource name	miiw2

Checking the values to be configured in the cluster environment with 3 nodes (hybrid type)

Target	Parameter	Value
	Monitored target	eth0 (Interface of public)
	When error is detected	"failover1" group's Failover
Fifth monitor resource (Automatically created after creating hybrid disk resource)	Type	hybrid disk connect monitor
	Monitor resource name	hdnw1
	Monitored hybrid disk resource	hd1
	When error is detected	No operation
Sixth monitor resource (Automatically created after creating hybrid disk resource)	Type	hybrid disk monitor
	Monitor resource name	hdw1
	Monitored hybrid disk resource	hd1
	When error is detected	No operation

Creating the configuration data of a 3-nodes cluster (hybrid type)

Creating the cluster configuration data involves creating a cluster, server group, group, monitor resources and modifying cluster properties. The steps you need to take to create the data are described in this section.

Note:

The following instruction can be repeated as many times as necessary. Most of the settings can be modified later by using the rename function or properties view function.

1. Create a cluster

Add a cluster you want to create and enter its name.

1-1. Add a cluster

Add a cluster. Make settings such as IP addresses.

1-2. Add the first server

Add a server. Make settings such as IP addresses.

1-3. Add the second server

Add a server. Make settings such as IP addresses.

1-4. Add the third server

Add a server. Make settings such as IP addresses.

2. Create a server group

Create a server group that bundles servers.

2-1. Add a (first) server group

Add a server group for the servers connected by a shared disk.

2-2. Add a (second) server group

Add a server group for servers which use ordinary disks.

3. Create a failover group

Create a failover group that works as a unit when a failover occurs.

3-1. Add a group for management

Add a group that works as a unit when a failover occurs.

3-2. Add a group 1 (failover1) for operation

Add a resource that constitutes a group.

3-3. Configure server groups

Associate a failover group with a server group.

3-4. Add a group resource (floating IP address)

Add a resource that constitutes a group.

3-5. Add a group resource (hybrid disk resource)

Add a resource that constitutes a group.

3-6. Add a group resource (EXEC resource)

Add a resource that constitutes a group.

4. Create monitor resources

Create a monitor resource that monitors specified target in a cluster.

4-1. Add a monitor resource (disk monitor resource)

Add a monitor resource to use.

4-2. Add a monitor resource (NIC Link Up/Down monitor resource for management group)

Add a monitor resource to use.

4-3. Add a monitor resource (NIC Link Up/Down monitor resource for application group (failover1))

Add a monitor resource to use.

5. Modify cluster properties

Modify the settings not to perform server down notification.

1. Creating a cluster

Create a cluster. Add a server that constitute a cluster and determine a heartbeat priority.

1-1. Add a cluster

1. On the **File** menu of the Builder, click **Cluster Generation Wizard**. The **Cluster Generation Wizard** is displayed. In the Language field, select a language that is used on the machine that the WebManager works.

Note:

On the WebManager, only one language is available within one cluster. If multiple languages are used within a cluster, specify English to avoid garbled characters.

2. In the **Cluster Definition** dialog box, type the cluster name (cluster) in the **Name** box, and then click **Next**.

1-2. Add the first server

Add information of each server that constitutes a cluster.

1. The **Server Definitions** is displayed.

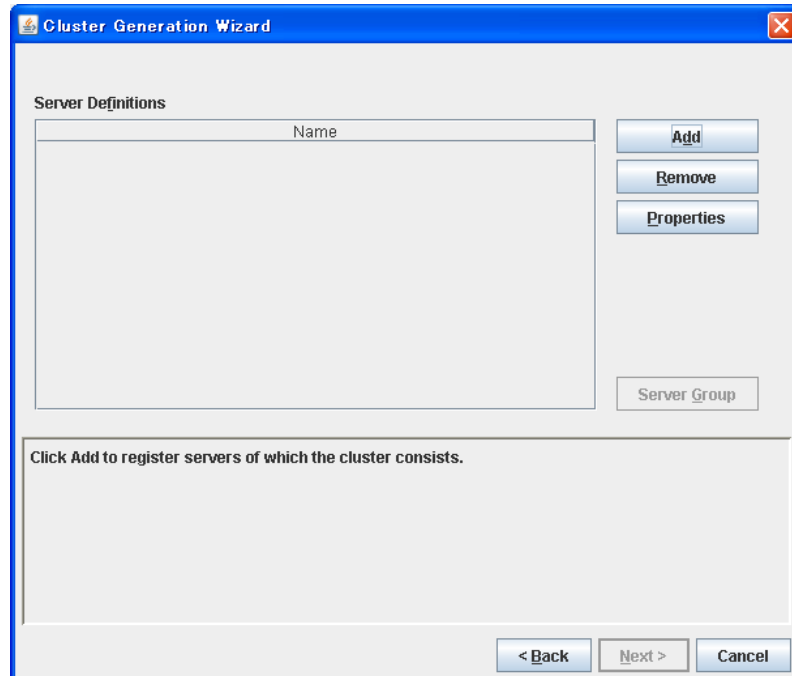

2. In the **Server Definitions** list, click **Add**.
3. In the **Server Definition** dialog box is displayed. Enter the data of the first server. Enter the server name (**server1**) in the **Name** box, and then click **Next**.

Note:

Enter the actual host name of the server. Make sure to type it correctly because the information you enter here is case sensitive.

4. Set up an interconnect LAN. Click **Add** and enter the interconnect IP address (dedicated) **192.168.0.1** in the **IP Address** box. Click **OK**.
5. The IP address you have entered is displayed in **Interconnect LAN I/F**. Enter the interconnect LAN IP address (backup) **10.0.0.1**. Click **Next**.
6. Click **Add** and enter the IP address of the public LAN **10.0.0.1** in the **IP Address** box. Click **OK**.
7. The IP address you have entered is set in **Public LAN I/F**. Click **Next**.
8. The COM heartbeat device setting window is displayed. Nothing needs to be configured. Click **Next**.
9. The disk heartbeat device setting window is displayed. Click **Add** and enter the actual device name **/dev/sdb3** in the **Device Name** box and the device name for raw access **/dev/raw/raw1** in the **Raw Device** box. Click **OK**.
10. The devices entered are set in the **Disk I/F**. Click **Next**.
11. Nothing needs to be configured in **Ping I/F**. Click **Next**.
12. Click **Add** and enter mirror disk connect **192.168.0.1** in the **IP address** box. Click **OK**.
13. Entered IP address is set in **Mirror Disk Connect I/F**. Click **Finish**.

The **Server Definitions** should look similar to the following. The server defined first becomes the master server by default.

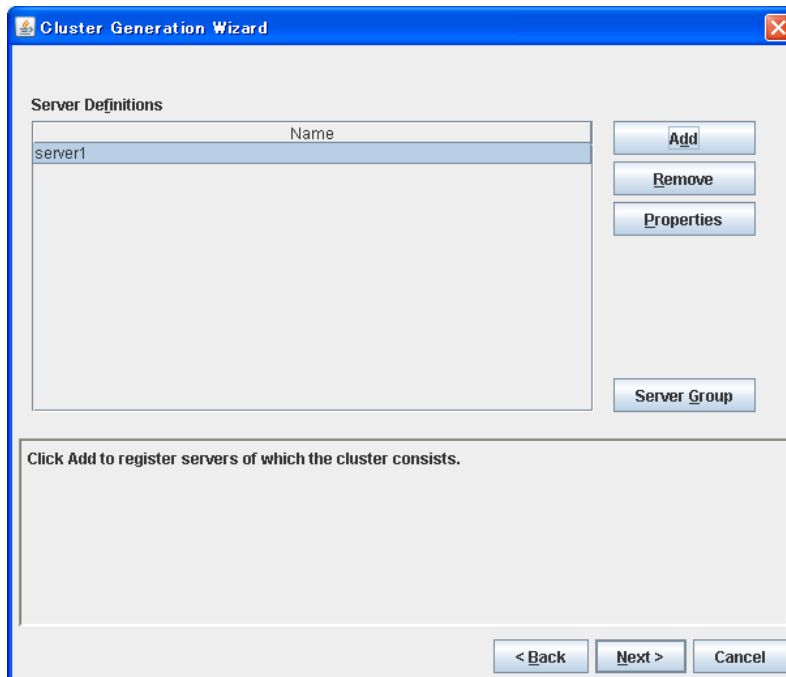

1-3. Add the second server

Enter the second server information after the first server information.

1. In the **Server Definitions** list, click **Add**.
2. In the **Server Definition** dialog box, enter the server name **server2** in the **Name** box, and then click **Next**.

Note: Enter the actual host name of the server. The information you enter here is case sensitive.

3. When you define the second server and rest of servers, you will see I/Fs in definition as many as you find in the master server. The IP address is blank by default. Set the IP address corresponding to the I/F number registered in other servers.

Click **Edit** and enter the interconnect LAN IP address (dedicated) **192.168.0.2** in the **IP Address** box. Click **OK**.

4. The IP address you have entered is set in **Interconnect LAN I/F**.

Likewise, select [2] of **I/F No.**, click **Edit**, and enter the LAN IP address (Backup) **10.0.0.2**. Click **Next**.

5. Click **Edit** and enter the public IP address **10.0.0.2** in the **IP Address** box. Click **OK**.
6. Check to see the IP address you have entered in the **Public LAN I/F** is set. Click **Next**.
7. Nothing needs to be configured in the COM heartbeat device settings window. Click **Next**.
8. The same number of I/F as the master server I/F is displayed. The disk device name and raw device name of a master server are set by default. Click **Next** without changing the settings.
9. Nothing needs to be configured in **Ping I/F**. Click **Next**.
10. In server definition after the second server, the same number of I/F as the master server I/F is displayed. The IP address is blank by default. Configure the IP address corresponding to I/F number registered to other servers.
Click **Edit** and enter mirror disk connect **192.168.0.2** in the **IP address** box. Click **OK**. Verify that the IP address entered is registered to **Mirror Disk Connect I/F** and click **Finish**.

The **Server Definitions** should look similar to the following.

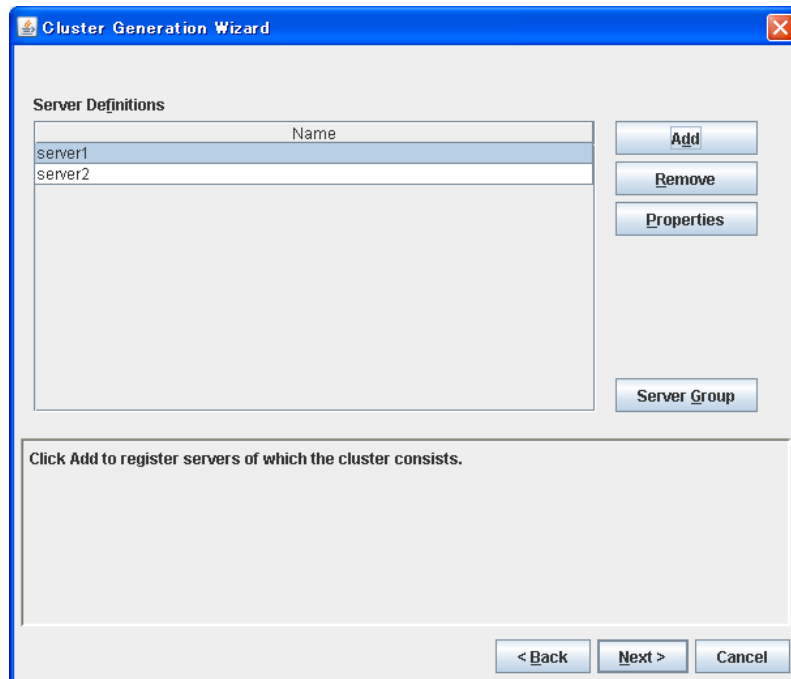

1-4. Add the third server

Enter the third server information corresponding to the information of the first server.

1. In the **Server Definitions** list, click **Add**.
2. In the **Server Definition** dialog box, enter the server name **server3** in the **Name** box, and then click **Next**.

Note: Enter the actual host name of the server. The information you enter here is case sensitive.

3. When you define the second server and rest of servers, you will see I/Fs in definition as many as you find in the master server. The IP address is blank by default. Set the IP address corresponding to the I/F number registered in other servers.

Click **Edit** and enter the interconnect LAN IP address (dedicated) **192.168.0.3** in the **IP Address** box. Click **OK**.

4. The IP address you have entered is set in **Interconnect LAN I/F**.

Likewise, select [2] of **I/F No.**, click **Edit**, and enter the LAN IP address (Backup) **10.0.0.3**. Click **Next**.

5. Click **Edit** and enter the public IP address **10.0.0.3** in the **IP Address** box. Click **OK**.
6. Check to see the IP address you have entered in the **Public LAN I/F** is set. Click **Next**.
7. Nothing needs to be configured in the COM heartbeat device settings window. Click **Next**.
8. I/Fs as many as the number in the master server are displayed. The disk device name and raw device name of a master server are set by default. Click **Edit**.
9. Delete the device name and raw device name (to be blank) and then click **OK**. The disk heartbeat window is displayed again. Click **Next**.
10. Nothing needs to be configured in **Ping I/F**. Click **Next**.

11. In server definition after the second server, the same number of I/F as the master server I/F is displayed. The IP address is blank by default. Configure the IP address corresponding to I/F number registered to other servers.

Click **Edit** and enter mirror disk connect **192.168.0.2** in the **IP address** box. Click **OK**. Verify that the IP address entered is registered to **Mirror Disk Connect I/F** and click **Finish**.

The **Server Definitions** list should look similar to the following.

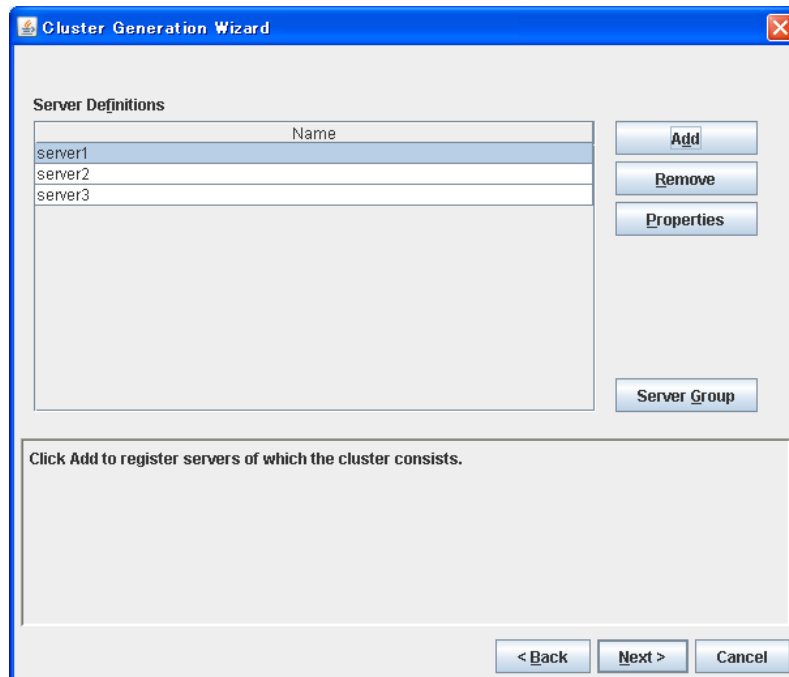

2. Creating a server group

Configure the unit to share the disk of a hybrid disk.

2-1. Create the first server group

Create the first server group.

1. Click **Server Group** in the **Server Definitions** window.
2. In the **Server Group Definitions** list, click **Add**.
3. The **Server Group Definition** dialog box is displayed. Enter the server group name (**svg1**) in the **Name** box, and then click **Next**.
4. Select **server1** on **Available Servers** and click **Add**.
5. Select **server1** on **Available Servers** and click **Add**.
6. Click **Finish**.

The **Server Group Definitions** list should look similar to the following.

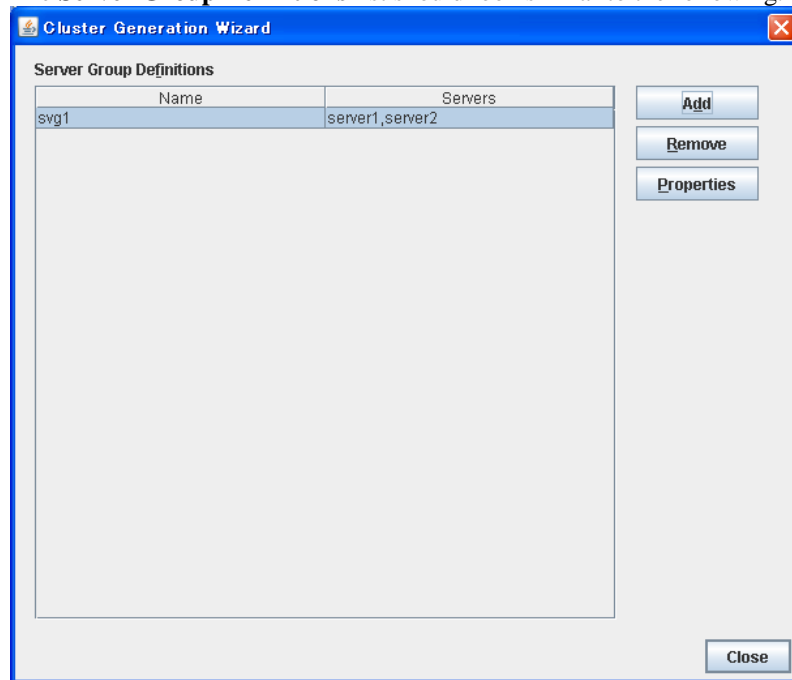

2-2. Create the second server group

Create the second server group.

1. In the **Server Group Definitions** list, click **Add**.
2. The **Server Group Definition** dialog box is displayed. Enter the server group name (**svg2**) in the **Name** box, and then click **Next**.
3. Select **server3** on **Available Servers** and click **Add**.
4. Click **Finish**.

The **Server Group Definitions** list should look similar to the following. Click **Close**.

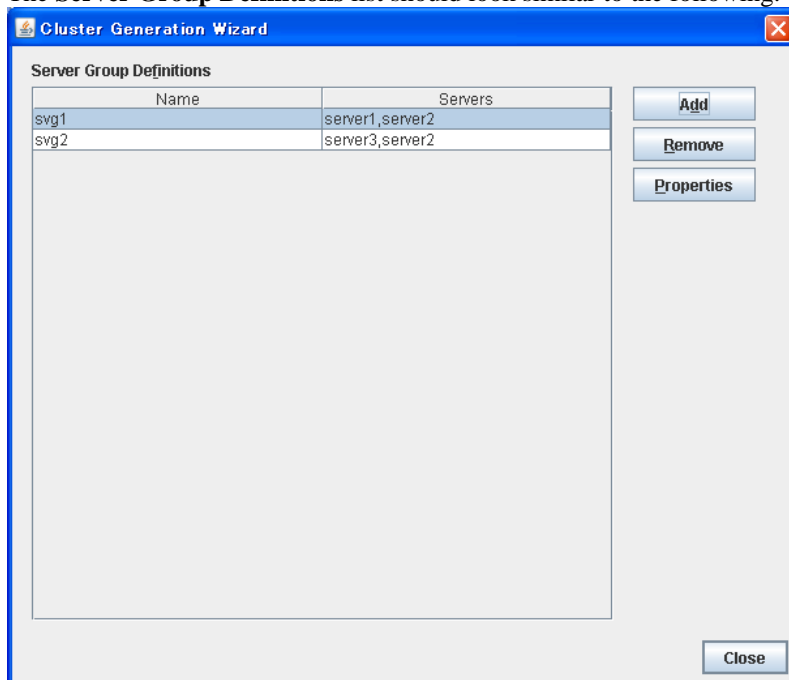

3. Creating a failover group

Add a failover group to the cluster. First, create a failover group for management and then add a failover group that executes an application.

3-1. Add a group for management

When you add a group to a failover group, first create a group for the WebManager. This group uses a floating IP and accesses servers in the cluster from a management PC. This allows access from the WebManager to a server that has failed over even if one of the servers goes down and failover occurs.

1. Click **Next** in the **Group Definitions** list.
2. The **Group Definitions** list is displayed.

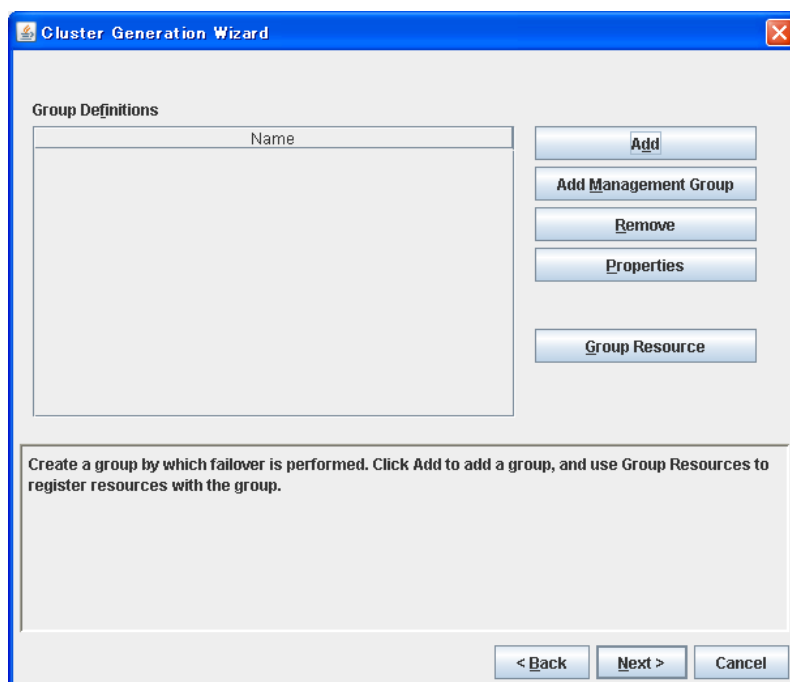

3. Click **Add Management Group**. **ManagementGroup** is added and displayed in the **Group Definitions** list.
4. Click **Group Resource** with **ManagementGroup** selected. **Group Resource Definitions** is displayed. Click **Add**.
5. In the **Type** box, select the group resource type (floating ip resource). In the **Name** box, the default name (ManagementIP) is entered. Click **Next**.
6. Enter the floating IP address (10.0.0.11) in the **IP Address** box, and then click **Next**.
7. **Recovery Operation at Activation Failure Detection** and **Recovery Operation at Deactivation Failure Detection** are displayed. Click **Next**.
8. A page for setting up a dependency is displayed. Click **Finish**.

9. **Group Resource Definitions** is displayed. Confirm that the Management IP is registered, and then click **Close**.

A group for management is added. The **Cluster Generation Wizard** should look similar to the following:

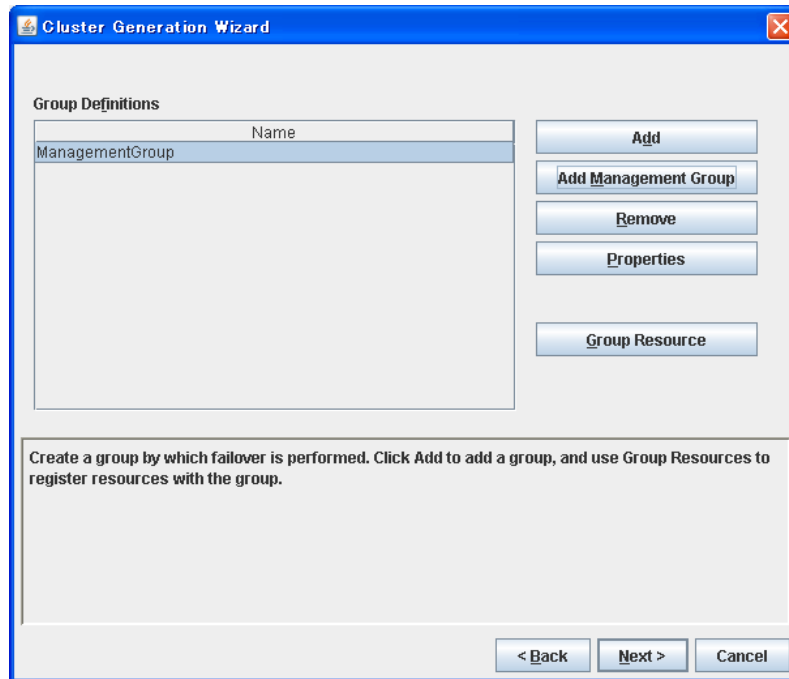

3-2. Add a group for operation

Set up a group that works as a unit of failover at the time an error occurs.

1. In the **Group Definitions** list, click **Add**.
2. In the **Group Definition** dialog box, enter the group name (**failover1**) in the **Name** box, and click **Next**.
3. Confirm that **Failover is possible at all servers** is selected. There is no need to change the server starting up priority on this example(The priority is server1 -> server2 -> server3). Click **Finish**.

A failover group is added. The **Group Definitions** list should look similar to the following:

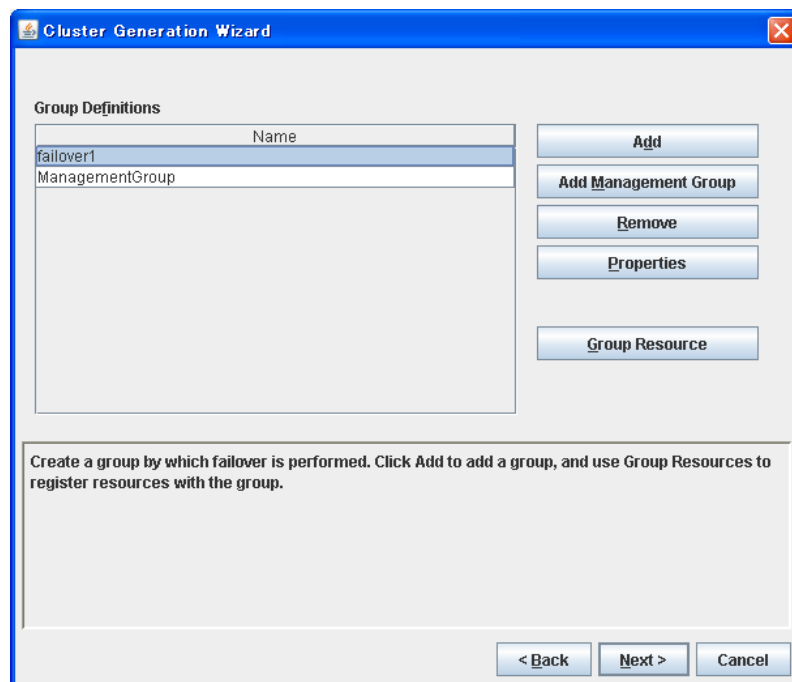

3-3. Configure a server group

Associate a failover group with a server group.

1. In the Group Definitions list, click Properties with **failover1** selected.
2. Click Server Group tab. Select **svg1** on **Available Servers** and click **Add**
3. Likewise, select **svg2** on **Available Servers** and click **Add**.

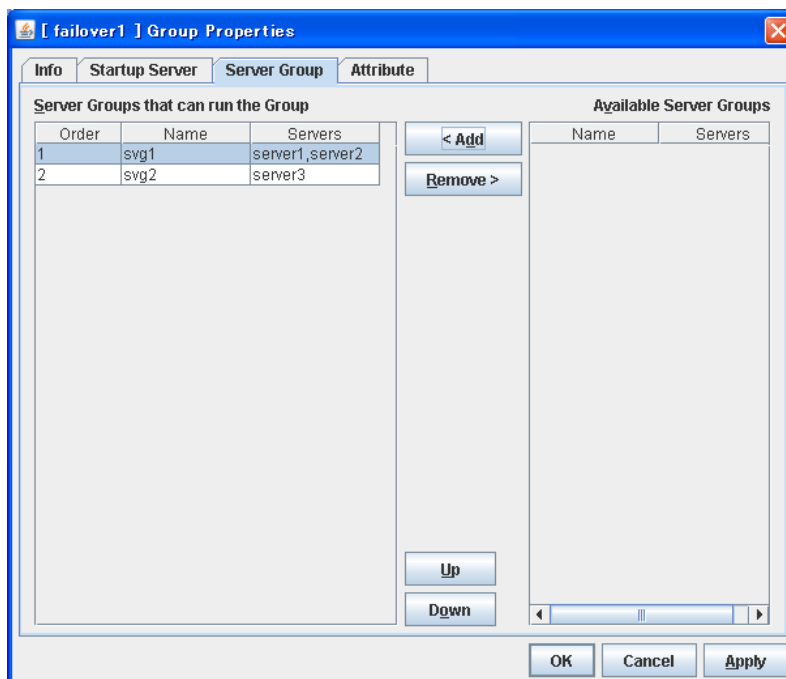

4. Check the window looks similar to the above, and click **OK**.

3-4. Add a group resource (floating IP address)

Add a group resource, a configuration element of the group, to the failover group you have created in Step 2-2.

1. In the **Group Definitions** list, click **Group Resource** with **failover1** selected.
2. Click **Add** in the **Group Resource Definitions** list.
3. In the **Resource Definition** dialog box, select the group resource type **floating ip resource** in the **Type** box, and enter the group name **fip1** in the **Name** box. Click **Next**.
4. Enter the IP Address **10.0.0.12** in the **IP Address** box. Click **Next**.
5. **Recovery Operation at Activation Failure Detection** and **Recovery Operation at Deactivation Failure Detection** are displayed. Click **Next**.
6. A page for setting up a dependency is displayed. Click **Finish**.

3-5. Add a group resource (hybrid disk resource)

1. In the **Group Resource Definitions** list, click **Add**.
2. In the **Resource Definition** dialog box, select the group resource type **hybrid disk resource** in the **Type** box, and enter the group resource name **hd1** in the **Name** box. Click **Next**.
3. Enter the device name **/dev/sdb2**, mount point **/mnt/hd1** to their corresponding boxes. Select the file system **ext3** from the **File System** box and the disk type **Disk** from the **Disk Type** box. Click **Next**.
4. **Recovery Operation at Activation Failure Detection** and **Recovery Operation at Deactivation Failure Detection** are displayed. Click **Next**.
5. A page for setting up a dependency is displayed. Click **Finish**.

3-6. Add a group resource (exec resource)

Add an exec resource that can start and stop the application from a script.

1. In the **Group Resource Definitions** list, click **Add**.
2. In the **Resource Definition** dialog box, select the group resource **execute resource** in the **Type** box, and enter the group resource name **exec1** in the **Name** box. Click **Next**.
3. Select **Script created with this product**. Edit the script if applications to be used in ExpressCluster are already decided. Users may edit this script to describe the procedure to start and stop a group of applications. Click **Next**.
4. **Recovery Operation at Activation Failure Detection** and **Recovery Operation at Deactivation Failure Detection** are displayed. Click **Next**.
5. A page for setting up a dependency is displayed. Click **Finish**.

The **Group Resource Definitions** list of the failover1 should look similar to the following:

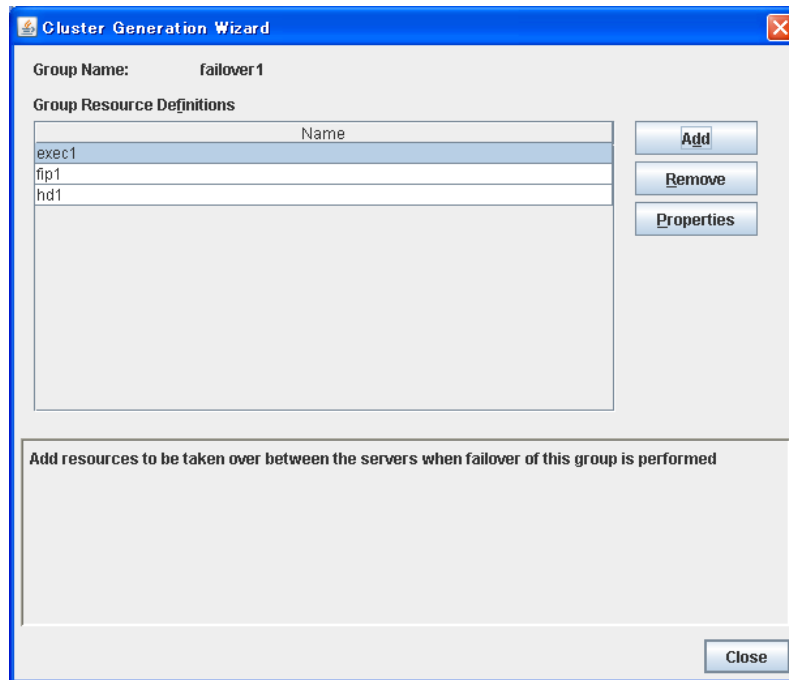

6. Click **Close**.

4. Add a monitor resources

Add a monitor resource that monitors a specified target to the cluster.

4.1 Add a monitor resource (disk monitor)

Add monitor resources to monitor the target disk. “diskw” is used as an example of a monitor resource to be added.

1. In the **Group Definitions** list, click **Next**.
2. In the **Monitor Resource Definitions** list, click **Add**.
3. The **Monitor Resource Definition** dialog box is displayed. The first monitor resource information is created by default when the cluster name is defined. The fifth and the sixth monitor resources are created in default when the hybrid disk resource is added. Select the monitor resource type **disk monitor** in the **Type** box, and enter the monitor resource name **diskw1** in the **Name** box. Click **Next**.
4. Enter the target monitor disk (**/dev/sdb2**). Select (READ (O_DIRECT)) for **monitoring method**. Click **Next**.
5. Configure the monitor settings. Do not change the default value and click **Next**.
6. Specify the recovery target. Click **Browse**.
7. Click **cluster** in the tree view shown. Click **OK**. **Cluster** is set in **Recovery target**.
8. Select **Stop the cluster daemon and shut down OS** in the **Final Action** box, and click **Finish**.

4-2. Add a monitor resource (NIC Link Up/Down monitor for management group)

Add monitor resources that monitor NIC. NIC Link Up/Down monitor needs to be created on a failover group basis. Because the example used here has two groups, a group for management and a group for an application. A NIC Link Up/Down monitor is created for each group.

1. In the **Monitor Resource Definitions** list, click **Add**.
2. In the **Monitor Resource Definition** dialog box, select the monitor resource type **NIC Link Up/Down monitor** in the **Type** box, and enter the monitor resource name **miw1** in the **Name** box. Click **Next**.
3. Enter the NIC (eth0) to be monitored in the **Monitor Target** box, and click **Next**.
4. Configure the monitor settings. Do not change the default value. Click **Next**.
5. Specify the recovery target. Click **Browse**.
6. Click **ManagementGroup** in the tree view and click **OK**. **ManagementGroup** is set in the **Recovery Target**.
7. Set **0** in the **Reactivation Threshold** box, and set **1** in the **Failover Threshold**. . Click **Finish**.

4-3. Add a monitor resource (NIC Link Up/Down monitor resource for management group)

1. In the **Monitor Resource Definitions** list, click **Add**.

2. In the **Monitor Resource Definition** dialog box, select the monitor resource type **NIC Link Up/Down monitor** in the **Type** box, and enter the monitor resource name **miiw2** in the **Name** box. Click **Next**.
3. Enter the NIC (eth0) to be monitored in the **Monitor Target** box, and click **Next**.
4. Configure the monitor settings. Click **Next**.
5. Specify the recovery target. Click **Browse**.
6. Click **failover1** in the tree view. Click **OK**. “failover1” is set in the **Recovery Target**.
7. Set **0** in the **Reactivation Threshold** box, and set **1** in the **Failover Threshold**. . Click **Finish**.

The **Monitor Resource Definitions** list should look similar to the following:

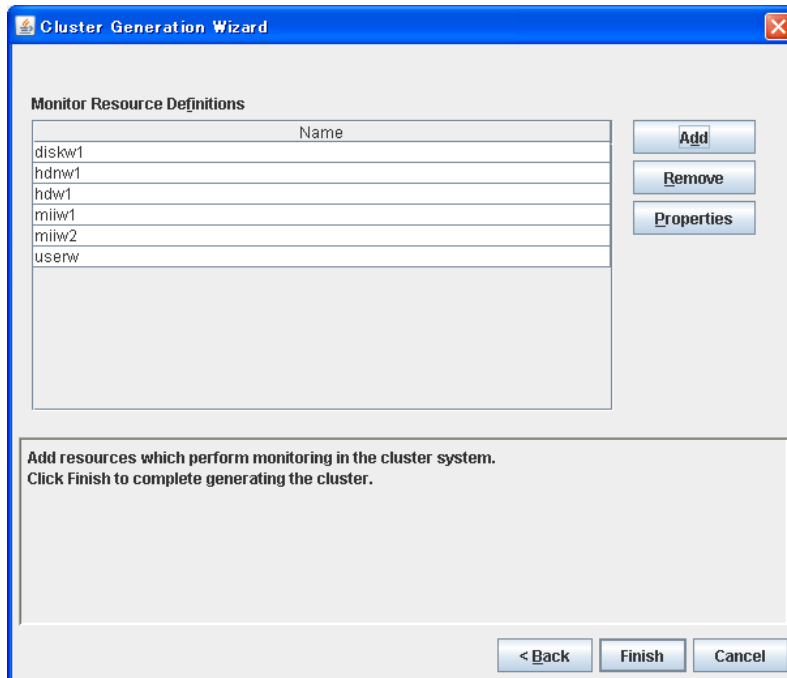

8. Click **Finish**.

Creating the cluster configuration data is completed. Proceed to “Creating a cluster” on page 154.

5. Modify a cluster properties

1. Right-click **Cluster** on the tree view and select **Properties**.
2. The **Cluster Properties** dialog box is displayed. Click **Heartbeat I/F** tab. Clear the **Server Down Notification** check box.

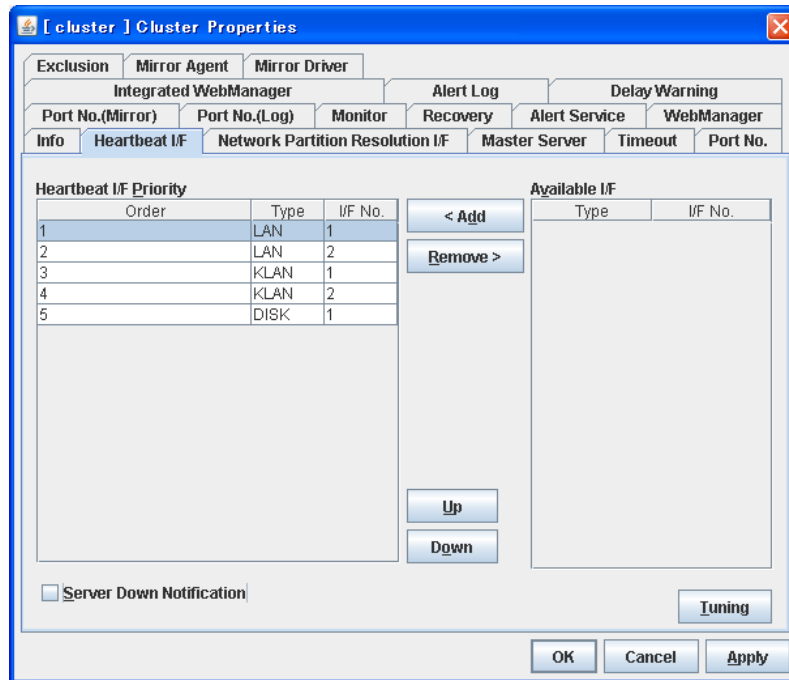

3. Click **OK**.

This completes creating the cluster configuration information. Proceed to Creating a cluster on page 154.

Saving the cluster configuration data

The cluster configuration data can be saved in a file system or in media such as a floppy disk. When starting the Builder on the WebManager, you can reflect the saved cluster information to the server machine with the ExpressCluster Server installed via the WebManager.

Saving the cluster configuration data in the file system (Linux)

Follow the procedures below to save cluster configuration data in file system when using Linux machine.

1. Select **Save** on the **File** menu of the Builder.
2. Click **File System** in the following dialog box, and click **OK**.

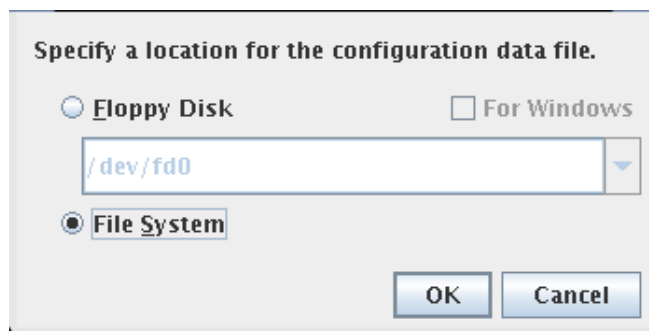

3. Select a location to save the data in the following dialog box, and click **Save**. Specify this directory when executing the creation command later.

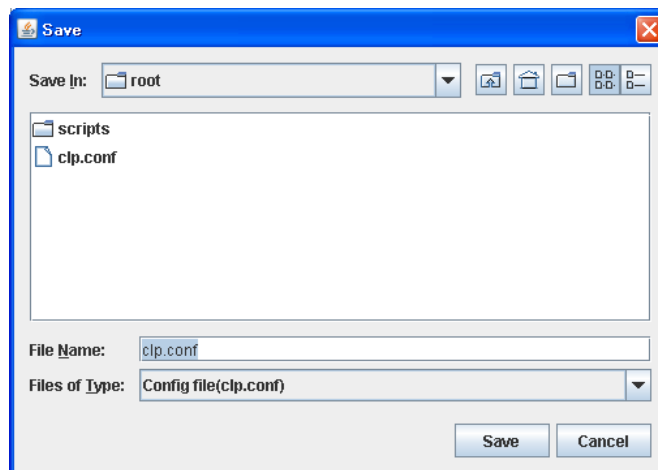

Note:

Three files (clp.conf, clp.conf.bak and clp.conf.rep) and one directory (scripts) are saved. If any of these are missing, the command to create a cluster does not run successfully. Make sure to treat these three as a set. When new configuration data is edited, clp.conf.bak is created in addition to these three.

The file and directory can be seen only when **For Windows** or **File System** is selected.

When the cluster configuration data is saved, the following message is displayed.

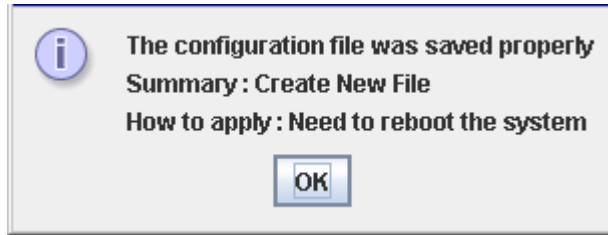

4. Check the file system and verify if the two files (clp.conf and clp.conf.rep) and the directory (scripts) are located in the directory for storing.

Saving the cluster configuration data in the file system (Windows)

Follow the procedures below to save the cluster configuration data in file system when using a Windows machine.

1. Select **Save** on the **File** menu of the Builder.
2. Select a location to save the data in the following dialog box, and click **Save**.

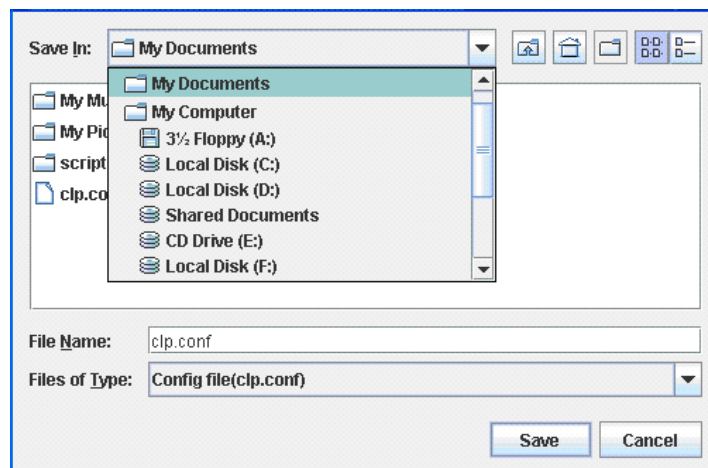

3. Select a location to save the data in the following dialog box, and click **Save**. Specify this directory when executing the creation command later.

Note:

Three files (clp.conf, clp.conf.bak and clp.conf.rep) and one directory (scripts) are saved. If any of these are missing, the command to create a cluster does not run successfully. Make sure to treat these three as a set. When new configuration data is edited, clp.conf.bak is created in addition to these three.

When the cluster configuration data is saved, the following message is displayed.

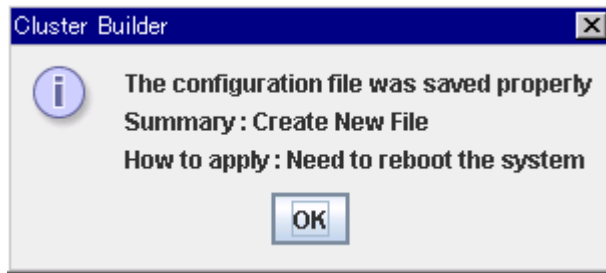

4. Check the file system and verify if the two files (clp.conf and clp.conf.rep) and the directory (scripts) are located in a directory to be saved.

Saving the cluster configuration data on a floppy disk (Linux)

Follow the procedures below to save the cluster configuration data created with the Builder on Linux machine to a floppy disk.

1. Insert a floppy disk into the floppy disk drive. Click **Save** on the **File** menu.
2. The following dialog box is displayed. Select the floppy disk drive name and click **OK**. You can save the data directly in the floppy disk without creating any directory in the floppy.

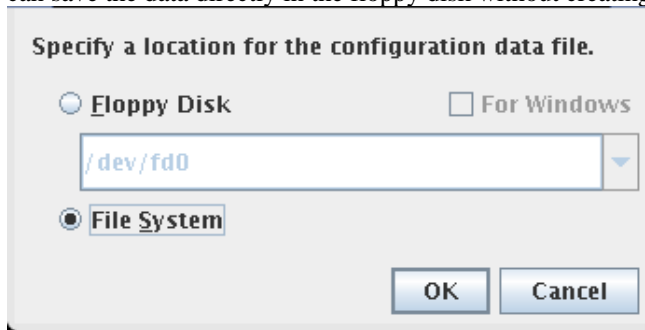

Note:

If you want to edit the cluster configuration data in the Builder that runs on the Windows browser, select **For Windows**. In this case, you need to prepare a Windows FAT (VFAT) formatted 1.44-MB floppy disk.

Two files (clp.conf and clp.conf.rep) and one directory (scripts) are saved. If any of these are missing, the command to create a cluster does not run successfully. Make sure to treat these three as a set. When new configuration data is edited, clp.conf.bak is created in addition to these three.

When the cluster configuration data is saved, the following message is displayed.

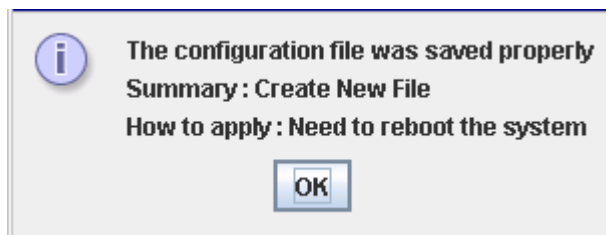

3. Check the floppy disk and verify if two files (clp.conf, clp.conf.rep) and one directory (scripts) are saved directly to the floppy disk.

Saving the cluster configuration data on a floppy disk (Windows)

Follow the procedures below to save the cluster configuration data created with the Builder on Windows machine to a floppy disk.

1. Prepare a formatted 1.44-MB floppy disk.
2. Insert the floppy disk into the floppy disk drive. Click **Save** on the **File** menu.
3. The following dialog box is displayed. Select the floppy disk drive in the **Save** box and click **Save**.

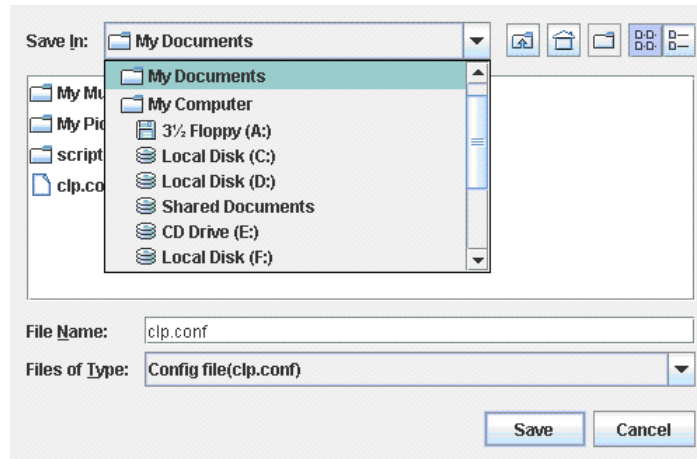

Note:

If you want to edit the cluster configuration data in the Builder that runs on the Windows browser, select **For Windows**. In this case, you need to prepare a Windows FAT (VFAT) formatted 1.44-MB floppy disk. For more details, see the *Reference Guide*.

Two files (clp.conf and clp.conf.rep) and one directory (scripts) are saved. If any of these are missing, the command to create a cluster does not run successfully. Make sure to treat these three as a set. When new configuration data is edited, clp.conf.bak is created in addition to these three.

When the cluster configuration data is saved, the following message is displayed:

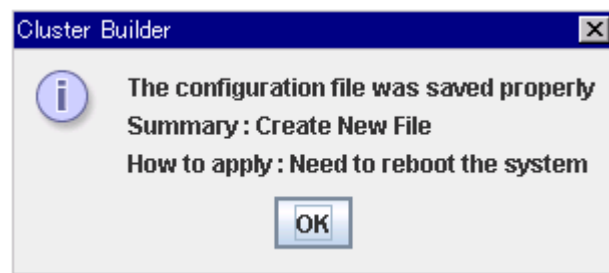

4. Check the floppy disk and verify if two files (clp.conf, clp.conf.rep) and one directory (scripts) are saved directly to the floppy disk.

Creating a cluster

After creating and/or modifying a cluster configuration data, reflect the configuration data on the servers that constitute a cluster and create a cluster system.

How to create a cluster

After creation and modification of the cluster configuration data are completed, create a cluster in the following procedures.

1. Click Upload the Configuration File on the File menu.
If the upload succeeds, the message saying “The upload is completed successfully. To start the cluster, refer to "How to create a cluster" in the Installation and Configuration Guide.” is displayed. If the upload fails, perform the operations as prompted by messages.
2. Terminate the Builder.
3. Execute a relevant procedure below depending on the resource to use.
 - ◆ When using a hybrid disk resource
 - (1) Initialize the hybrid disk resource.
 - Group resource with two servers (When using hybrid disk resource for shared disk)
Execute the following clphdinit command in one of the servers in group resource.
clphdinit --create force
 - Group resource with one server (When using internal hybrid disk resource or hybrid disk resource of non-shared external disk)
Execute the following clphdinit command in the server.
clphdinit --create force
 - (2) After executing above in the relevant server in the cluster, proceed the following steps.
 - (3) Restart all servers. After restarting the servers, clustering starts and the status of clustering is displayed on WebManager.
 - ◆ When using mirror disk resource
 - (1) Restart all servers. After restarting the servers, clustering starts and the status of clustering is displayed on WebManager.
 - ◆ When using neither mirror disk resource nor hybrid disk resource
 - (1) Execute **Restart Manager** from the **Service** menu of WebManager.
 - (2) Execute **Start clustering** from the **Service** menu of WebManager. Clustering starts and the status of clustering is displayed on WebManager.

Chapter 6 Verifying a cluster system

This chapter describes how you change the cluster configuration.

This chapter covers:

- Verifying operations using the WebManager..... 156
- Verifying operation by using commands 158

Verifying operations using the WebManager

The cluster system you have set up can be verified by using the WebManager or the command line. This chapter provides instructions for verifying the cluster system using the WebManager. The WebManager is installed at the time of the ExpressCluster Server installation. Therefore, it is not necessary to install it separately. The WebManager can be accessed from a management PC. The following describes how to access to the WebManager.

Related Information:

For system requirements of the WebManager, refer to Chapter 3, “System requirements for the WebManager” in the *Getting Started Guide*.

Follow the steps below to verify the operation of the cluster after creating the cluster and connecting to the WebManager.

Related Information:

For details on how to use the WebManager, see Chapter 1, “Functions of the WebManager” in the *Reference Guide*. If any error is detected while verifying the operation, troubleshoot the error referring to Chapter 11, “Troubleshooting” in the *Reference Guide*.

1. Check heartbeat resources

Verify that the status of each server is online on the WebManager.
Verify that the heartbeat resource status of each server is normal.

2. Check monitor resources

Verify that the status of each monitor resource is normal on the WebManager.

3. Start up a group

Start a group.
Verify that the status of the group is online on the WebManager.

4. Check a disk resource

Verify that you can access the disk mount point on the server where the group having a disk resource is active.

5. Check a mirror disk resource/hybrid disk resource

Verify that you can access the disk mount point on the server where the group having a mirror disk resource/hybrid disk resource is active.

6. Check a floating IP resource

Verify that you can ping a floating IP address while the group having the floating IP resource is active.

7. Check an exec resource

Verify that an application is working on the server where the group having an exec resource is active.

8. Stop a group

Stop a group.
Verify that the status of the group is offline on the WebManager.

9. Move a group

Move a group to another server.
Verify that the status of the group is online on the WebManager.
Move the group to all servers in the failover policy and verify that the status changes to online on each server.

10. Perform failover

Shut down the server where a group is active.

After the heartbeat timeout, check to see the group has failed over. Verify that the status of the group becomes online on the failover destination server on the WebManager.

11. Perform failback

When the automatic failback is set, start the server that you shut down in the previous step, “9. Failover.” Verify that the group fail back to the original server after it is started using the clpstat command. Verify that the status of group becomes online on the failback destination server on the WebManager.

12. Shut down the cluster

Shut down the cluster. Verify that all servers in the cluster are successfully shut down using the clpstat command.

Verifying operation by using commands

Follow the steps below to verify the operation of the cluster from a server constituting the cluster using command lines after the cluster is created.

Related Information:

For details on how to use commands, see Chapter 4, “ExpressCluster command reference” in the *Reference Guide*. If any error is detected while verifying the operation, troubleshoot the error referring to Chapter 11, “Troubleshooting” in the *Reference Guide*.

1. Check heartbeat resources

Verify that the status of each server is online by using the `clpstat` command.
Verify that the heartbeat resource status of each server is normal.

2. Check monitor resources

Verify that the status of each monitor resource is normal by using the `clpstat` command.

3. Start groups

Start the groups with the `clpgrp` command.
Verify that the status of groups is online by using the `clpstat` command.

4. Stop a group

Stop a group with the `clpgrp` command.
Verify that the status of the group is offline by using the `clpstat` command.

5. Check a disk resource

Verify that you can access a disk mount point on the server where the group having disk resources is active.

6. Check a mirror disk resource/hybrid disk resource

Verify that you can access the disk mount point on the server where the group having a mirror disk resource/hybrid disk resource is active.

7. Check a floating IP resource

Verify that you can ping a floating IP address while the group having a floating IP resource is active.

8. Check an exec resource

Verify that an application is working on the server where the group having an exec resource is active.

9. Move a group

Move a group to another server by using the `clpstat` command.
Verify that the status of the group is online by using the `clpstat` command.
Move the group to all servers in the failover policy and verify that the status changes to online on each server.

10. Perform failover

Shut down a server where a group is active.
After the heartbeat timeout, check to see the group has failed over by using the `clpstat` command. Verify that the status of the group becomes online on the failover destination server using the `clpstat` command.

11. Perform failback

When the automatic failback is set, start the server which you shut down in the previous step, “9. Failover.” Verify that the group fails back to the original server after it is started using the `clpstat` command. Verify that the status of the group becomes online on the failback destination server using the `clpstat` command.

12. Shut down the cluster

Shut down the cluster by using the `clpstdn` command. Verify that all servers in the cluster are successfully shut down.

Chapter 7 **Modifying the cluster configuration data**

This chapter describes how you modify the cluster configuration data.

This chapter covers:

- Modifying the cluster configuration data 162
- Reflecting the cluster configuration data 165
- Online version Builder 166
- Offline version Builder..... 167
- Notes for using the offline Builder 171

Modifying the cluster configuration data

Before you reconfigure the ExpressCluster Server or change its parameters, you must back up the cluster configuration data. Backing up can be done with the `clpcfctrl` command. For details, see Chapter 4, “ExpressCluster command reference” in the *Reference Guide*.

Modify the cluster configuration data by using the ExpressCluster X Builder. For details of the ExpressCluster X Builder, see Chapter 3, “Functions of the Builder” in the *Reference Guide*.

The following describes procedures and precautions of modifying the cluster configuration data after creating a cluster.

Add the server

Add a server that constitutes a cluster.

1. Click **Servers** on the tree view, and click **Add** on the **Edit** menu.
 2. In the **Server Definition** dialog box, enter the data of the first server.
Enter the server name **server1** in the **Name** box, and then click **Next**. Enter the actual host name of the server. Make sure to type it correctly because the information you enter here is case sensitive.
 3. Set up an interconnect LAN. Click **Add** or **Edit** and enter the interconnect LAN IP address in the **IP Address** box. Click **OK**.
 4. The IP address you have entered is displayed in **Interconnect LAN I/F**. Enter the all interconnect LAN IP addresses to use. When you add all the IP addresses, click **Next**.
 5. Click **Add** or **Edit** and enter the public LAN IP address in the **IP Address** box. Click **OK**.
 6. The IP address you have entered is set in **Public LAN I/F**. Enter the all the public LAN IP addresses to use. When you add all the IP addresses, click **Next**.
 7. To send a heartbeat using RS-232C, click **Add** or **Edit** and enter COM heartbeat device name in the **Device Name** box. (Typically, leave the default name as it is.) Click **OK**.
 8. The device name you have entered is set in the **COM I/F**. Click **Next**.
 9. When a disk resource is used in the cluster environment, configure the settings of disk heartbeat. Click **Add** or **Edit** and enter the actual device name in the **Device Name** box and the device name for raw access in the **Raw Device** box. Click **OK**.
-
- Note:**
The raw device specified here is used for the heartbeat. Note that it is not a value for a raw monitor resource.
-
10. The devices entered are set in the **Disk I/F**. Click **Next**.
 11. Set up Ping network partition resolution resource. Click **Add** or **Edit**. On the IP address list, click **Add** or **Edit** with selecting a group No. on the group list that you want to edit, and enter the IP addresses in **IP Address**. Click **OK**.
 12. The entered device name is set in the **Ping I/F**. Click **Next**.
 13. When a mirror resource is used in the cluster environment, configure the settings of mirror disk connect. Click **Add** or **Edit** and enter the IP address of the mirror disk connect in **IP Address**. Click **OK**. The IP address entered is registered to **Mirror Disk Connect I/F**.
 14. Click **Finish**.

Add a group

Add a group by which a failover is performed.

1. Click **Groups** in the tree view, and click **Add** on the **Edit** menu.
2. In the **Group Definition** dialog box, enter the group name (failover1) in the **Name** box, and click **Next**.
3. **Servers that can run the Group** is displayed. Configure the settings, and then click **Finish**.

Add a group resource

Add a group resource. In this example, a floating IP resource is added.

1. Click the group to which a resource to be added belongs in the tree view. Click **Add** on the **Edit** menu.
2. In the **Resource Definition** dialog box, select the group resource type **floating ip resource** in the **Type** box, and enter the group name **fip1** in the **Name** box. Click **Next**.
3. Enter the IP Address **10.0.0.12** in the **IP Address** box. Click **Next**.
4. **Recovery Operation at Activation Failure Detection** and **Recovery Operation at Deactivation Failure Detection** are displayed. Configure the settings, and click **Next**.
5. A page for setting up a dependency is displayed. Configure the settings, and click **Finish**.

Add a monitor resource

Add monitor resources that monitor IP. In this example, an IP monitor resource is added.

1. Click **Monitors** in the tree view, and click **Add** on the **Edit** menu.
2. In the **Monitor Resource Definition** dialog box, select the monitor resource type **ip monitor** in the **Type** box, and enter the monitor resource name **ipw1** in the **Name** box. Click **Next**.
3. Click **Add**. Enter the IP address to be monitored in the **IP Address** box, and click **OK**.
4. Configure the monitor settings. Configure the settings, and click **Next**.
5. Specify the recovery target. Configure the settings, and click **Finish**.

Modifying the cluster configuration data by using the ExpressCluster Builder (online version)

1. Start the ExpressCluster Builder by using a browser.
http:// Management address for the WebManager group: port number (default value 29003)/
2. Click **Start Builder** on the title bar of the WebManager to start the Builder.
3. Modify the configuration data after the current cluster configuration data is displayed.
4. Upload the modified configuration data. Depending on the modified data, it may become necessary to suspend or stop the cluster and/or to restart by shutting down the cluster. In such a case, uploading is cancelled once and the required operation is displayed. Follow the displayed message and do as instructed to perform upload again.

Modifying the cluster configuration data by using the ExpressCluster Builder (offline version)

1. Start the ExpressCluster X Builder by using the Web browser.
(The path for installation) /clptrek.htm
2. Open the saved cluster configuration data.
3. When the cluster configuration data is displayed, modify it.
4. Save the modified configuration data.
5. Upload the configuration data from the server where ExpressCluster is saved by using the command prompt.

```
clpcfctrl --push -x <The path where configuration data is saved>
```

Depending on the data modified, it may become necessary to suspend or stop the cluster, or to restart by shutting down the cluster. In such a case, uploading is cancelled once and the required operation is displayed. Follow the displayed message and do as instructed to perform upload again.

Reflecting the cluster configuration data

Reflect the cluster configuration data on the ExpressCluster Server environment. The way to reflect them varies depending on the nature of the changes. For details on how to change parameters and how to reflect them, refer to the *Reference Guide*.

The way you reflect changed parameters may affect behavior of the ExpressCluster X. For details, see the table below:

The way to reflect changes	Effect
Upload Only	The operation of the applications and ExpressCluster Server is not affected.
Uploading data and restarting the WebManager	Heartbeat resources, group resources or resource monitor does not stop.
Uploading data after suspending the cluster	The operation of the ExpressCluster Server partly stops. While the ExpressCluster daemon is suspended, heartbeat resources and monitor resources stop. Applications continue operations since group resources do not stop.
Uploading data after stopping the cluster	All the operations of the ExpressCluster Server stop. Since groups are also stopped, applications are stopped until a cluster and groups are started after uploading data.
Shutting down and restarting a cluster after uploading data	Applications are stopped until a cluster is restarted and groups are started.
Uploading data after stopping mirror agents	All the operations of the ExpressCluster Server stop. Since groups are also stopped, applications are stopped until a cluster and groups are started after uploading data.

Note:

If the ExpressCluster daemon needs to be suspended or stopped to reflect the modified data, ensure it is suspended or stopped before reflecting the cluster configuration data.

Check if the message on the WebManager alert view shows “Module type: pm, Event type: information, Event ID: 2”. For more information on messages, see Section III in the *Reference Guide*.

When the WebManager is not available to use, check the syslog to see if “Module type: pm, Event type: information, Event ID: 2” are reported.

After checking the message above, reflect the cluster configuration data to the ExpressCluster environment.

Online version Builder

Uploading data only

1. Start the ExpressCluster Builder, and change the cluster configuration data.
2. Upload the cluster configuration data with the ExpressCluster Builder.
3. The following message is displayed if the data has successfully been distributed.
The upload is completed successfully.

Uploading data and restarting the WebManager

For details on how to restart the ExpressCluster WebManager, see Chapter 1 “Functions of the WebManager” in the *Reference Guide*.

1. Start the ExpressCluster Builder, and change the cluster configuration data.
2. Upload the cluster configuration data with the ExpressCluster Builder.
3. The following message is displayed if the data has successfully been distributed.
The upload is completed successfully.
4. Restart the WebManager.

Uploading data after suspending a cluster

The following explains how to suspend a cluster such as when changing a configuration (adding or deleting a server).

1. Start the ExpressCluster Builder, and change the cluster configuration data.
2. On the **Service** button of the WebManager, click **Suspend Cluster**.
3. Upload the cluster configuration data with the ExpressCluster Builder.
4. The following message is displayed if the data has been successfully distributed.
The upload is completed successfully.
5. On the **Service** button of the WebManager, click **Resume Cluster**.

Uploading data after stopping a cluster

1. Start the ExpressCluster Builder, and change the cluster configuration data.
2. On the **Service** button of the WebManager, click **Stop Cluster**.
3. Upload the cluster configuration data with the ExpressCluster Builder.
4. The following message is displayed if the data has successfully been distributed.
The upload is completed successfully.

Shutting down and restarting a cluster after uploading data

1. Start the ExpressCluster Builder, and change the cluster configuration data.
2. On the **Service** button of the WebManager, click **Stop Cluster**.
3. Upload the cluster configuration data with the ExpressCluster Builder.
4. The following message is displayed if the data has successfully been distributed.

The upload is completed successfully.
To apply the changes you made, restart the WebManager from the Service menu.

5. Restart all servers.

Uploading data after stopping mirror agents

1. Start the ExpressCluster Builder, and change the cluster configuration data.
2. On the **Service** button of the WebManager, click **Stop Cluster**.
3. On the **Service** button of the WebManager, click **Stop Mirror Agent**.
4. Upload the cluster configuration data with the ExpressCluster Builder.
5. The following message is displayed if the data has successfully been distributed.
The upload is completed successfully.
6. On the **Service** button of the WebManager, click **Start Mirror Agent**.
7. On the **Service** button of the WebManager, click **Start Cluster**.

Offline version Builder

Uploading data only

1. Insert the floppy disk in the server specified as the master server by the Builder.
2. Distribute the configuration data in the floppy disk to all the servers registered in the cluster configuration information. Do either (A) or (B) depending on the floppy disk type you used to save the data by the Builder:
 - (A) If you created the configuration data on a Linux computer, run the following command with the `-l` option:

```
clpcfctrl --push -l
```
 - (B) If you created the configuration data on a Windows computer (on 1.44-MB formatted floppy disk), or created the configuration data as a Windows file on Linux, run the following command with the `-w` option:

```
clpcfctrl --push -w
```
3. The following message is displayed if the data has successfully been distributed.
The upload is completed successfully. (cfmgr:0)
Command succeeded. (code:0)

For troubleshooting while running `clpcfctrl`, see Chapter 4, “ExpressCluster command reference” in the *Reference Guide*.
4. Remove the floppy disk from the floppy disk drive.

Uploading data and restarting the WebManager

1. Insert the floppy disk in the server specified as the master server by the Builder.
2. Distribute the configuration data in the floppy disk to all the servers registered in the cluster configuration information. Do either (A) or (B) depending on the floppy disk type you used to save the data by the Builder:
 - (A) If you created the configuration data on a Linux computer, run the following command with the `-l` option:

```
clpcfctrl --push -l
```

- (B) If you created the configuration data on a Windows computer (on 1.44-MB formatted floppy disk), or created the configuration data as a Windows file on Linux, run the following command with the `-w` option:

```
clpcfctrl --push -w
```

3. The following message is displayed if the data has successfully been distributed.

```
The upload is completed successfully.(cfmgr:0)
```

To apply the changes you made, restart the WebManager.

```
Command succeeded.(code:0)
```

For troubleshooting while running `clpcfctrl`, see Chapter 4, “ExpressCluster command reference” in the *Reference Guide*.

4. Remove the floppy disk from the floppy disk drive.
5. Restart the WebManager.

Uploading data after suspending a cluster

If you want to reconfigure the cluster by adding or deleting a server, follow the steps below and suspend the ExpressCluster daemon.

1. Run `clpctl -suspend` to suspend the ExpressCluster daemon.
2. Insert the floppy disk in the server specified as the master server by the Builder.
3. Distribute the configuration data in the floppy disk to all the servers registered in the cluster configuration information. Do either (A) or (B) depending on the floppy disk type you used to save the data by the Builder:

- (A) If you created the configuration data on a Linux computer, run the following command with the `-l` option:

```
clpcfctrl --push -l
```

- (B) If you created the configuration data on a Windows computer (on 1.44-MB formatted floppy disk), or created the configuration data as a Windows file on Linux, run the following command with the `-w` option:

```
clpcfctrl --push -w
```

4. After executing the command, the message below is displayed. Press **Y** and the **RETURN** key.

```
The upload is completed successfully.(cfmgr:0)
```

```
Command succeeded.(code:0)
```

5. After clicking the **RETURN** key, the following message is displayed if the data has successfully been distributed.

```
Command succeeded.(code:0)
```

For troubleshooting while running `clpcfctrl`, see Chapter 4, “ExpressCluster command reference” in the *Reference Guide*.

6. Remove the floppy disk from the floppy disk drive.
7. Run the `clpctl -resume` to resume the ExpressCluster daemon.

Uploading data after stopping a cluster

1. Run the `clpctl -t -a` to stop the ExpressCluster daemon.
2. Insert the floppy disk in the server specified as the master server by the Builder.
3. Distribute the configuration data in the floppy disk to all the servers registered in the cluster configuration information. Do either (A) or (B) depending on the floppy disk type you used to save the data by the Builder:

(A) If you created the configuration data on a Linux computer, run the following command with the `-l` option:

```
clpcfctrl --push -l
```

(B) If you created the configuration data on a Windows computer (on 1.44-MB formatted floppy disk), or created the configuration data as a Windows file on Linux, run the following command with the `-w` option:

```
clpcfctrl --push -w
```

The following message is displayed if the data has successfully been distributed.

```
The upload is completed successfully.(cfmgr:0)
Command succeeded.(code:0)
```

After clicking the **RETURN** key, the following message is displayed if the data has successfully been distributed.

```
Command succeeded.(code:0)
```

For troubleshooting while running `clpcfctrl`, see Chapter 4, “ExpressCluster command reference” in the *Reference Guide*.

4. Remove the floppy disk from the floppy disk drive.
5. Run the `clpctl -s -a` to restart the ExpressCluster daemon.

Shutting down and restarting a cluster after uploading data

1. Run `clpctl -t -a` to stop the ExpressCluster daemon.
2. Insert the floppy disk in the server specified as the master server when you created the configuration data by using the Builder.
3. Distribute the configuration data in the floppy disk to all the servers registered in the cluster configuration information. Do either (A) or (B) depending on the floppy disk type you used to save the data by the Builder:

(A) If you created the configuration data on a Linux computer, run the following command with the `-l` option:

```
clpcfctrl --push -l
```

(B) If you created the configuration data on a Windows computer (on 1.44-MB formatted floppy disk), or created the configuration data as a Windows file on Linux, run the following command with the `-w` option:

```
clpcfctrl --push -w
```

After clicking the **RETURN** key, the following message is displayed if the data has successfully been distributed.

```
The upload is completed successfully.(cfmgr:0)
```

To apply the changes you made, shutdown and reboot the cluster.

```
Command succeeded.(code:0)
```

For troubleshooting while running `clpcfctrl`, refer to Chapter 3, “Function of the Builder” in the *Reference Guide*.

4. Remove the floppy disk from the floppy disk drive.
5. Restart all servers.

Uploading data after stopping mirror agents

For details on how to stop or suspend mirror agents, see Chapter 1 “Functions of the WebManager” in the *Reference Guide*.

1. On the **Service** button of the WebManager, click **Stop Cluster**.
2. On the **Service** button of the WebManager, click **Stop Mirror Agent**.
3. Insert the floppy disk in the server specified as the master server when you created the configuration data by using the Builder. Do either (A) or (B) depending on the floppy disk type you have saved the data by the Builder:

(A) If you created the configuration data on a Linux computer, run the following command with the `-l` option:

```
clpcfctrl --push -l
```

(B) If you created the configuration data on a Windows computer (on 1.44-MB formatted floppy disk), or created the configuration data as a Windows file on Linux, run the following command with the `-w` option:

```
clpcfctrl --push -w
```

The following message is displayed if the data has successfully been distributed.

```
The upload is completed successfully. (cfmgr:0)
Command succeeded. (code:0)
```

For the troubleshooting of when running the `clpcfctrl` command, see Chapter 4 “ExpressCluster command reference” in the *Reference Guide*.

4. Remove the floppy disk from the floppy disk drive.
5. On the **Service** button of the WebManager, click **Start Mirror Agent**.
6. On the **Service** button of the WebManager, click **Start Cluster**.

Notes for using the offline Builder

The following describes notes for using the offline Builder.

Notes for changing cluster configuration data using a floppy disk

- ◆ Floppy disk device name and mount point

The `clpcfctrl` command uses `/dev/fd0` as a floppy disk device, and `/mnt/floppy` as a mount point.

This document assumes that the device above and mount point are available. However, the floppy disk device and mount point may be different depending on your environment, in which case, you need to specify the device and mount point with the `clpcfctrl` command option.

In `clpcfctrl` command samples provided below, substitute the `/dev/fd0` and `/mnt/floppy` with those in your environment.

- ◆ Manually mounting a floppy disk

Run the following command to view the data that is saved on the floppy disk using the Builder for Windows on Linux.

The example below assumes that the floppy disk device is `/dev/fd0` and the mount point is `/mnt/floppy`:

```
mount -w -t vfat -o shortname=mixed /dev/fd0 /mnt/floppy
```

- ◆ The supermount service

In some environments, the supermount service is enabled. If the settings are configured to use `/mnt/floppy` as a floppy disk mount point for supermount service, the `clpcfctrl` command to mount the floppy disk will fail.

In such a case, suspend the supermount service or use a different mount point.

To use a different mount point, use the `-m` option of the `clpcfctrl` command.

Related Information:

For details on options, see Chapter 4, “ExpressCluster command reference” in the *Reference Guide*.

Uploading the cluster configuration data using a floppy disk

Do either (1) or (2) below depending on the operating system on which you use the Builder. The following is an example when the floppy disk device is `/dev/hda` and mount point is `/mnt`.

1. To use the data saved in the floppy disk by the Builder on Linux, run the following command:

```
clpcfctrl --push -l -d /dev/hda -m /mnt
```

2. To use the data saved on the floppy disk (1.44-MB, formatted) by the Builder on Windows or has the data for Windows saved by the Builder on Linux, run the following command:

```
clpcfctrl --push -w -d /dev/hda -m /mnt
```

Related Information:

For details on the `clpcfctrl` command options, see Chapter 4, “ExpressCluster command reference” in the *Reference Guide*.

Backing up the cluster configuration data using a floppy disk

Do either (1) or (2) depending on the operating system on which you use the Builder. The following is an example when floppy disk device is `/dev/hda` and mount point is `/mnt`.

1. To back up data in the floppy disk for the Builder working on Linux Web browser, run the following command:

```
clpcfctrl --pull -l -d /dev/hda -m /mnt
```

2. To back up data in a floppy disk for the Builder working on Windows Web browser, run the following command:

```
clpcfctrl --pull -w -d /dev/hda -m /mnt
```

Related Information:

For details on the `clpcfctrl` command options, see Chapter 4, “ExpressCluster command reference” in the *Reference Guide*.

Uploading the cluster configuration data when a floppy disk is not available for use

You can access the cluster configuration data saved on the file system from the server you are uploading data. Access the cluster configuration data from the master server by using FTP.

Do either (1) or (2) depending on the operating system on which you use the Builder. The following example assumes that the cluster configuration data is in the /tmp/upload directory.

1. If you use the cluster configuration data saved by the Builder on Linux, run the following command:

```
clpcfctrl --push -l -x /tmp/upload
```

2. If you use the cluster configuration data saved by the Builder on Windows, run the following command:

```
clpcfctrl --push -w -x /tmp/upload
```

Related Information:

For details on the clpcfctrl command options, see Chapter 4, “ExpressCluster command reference” in the *Reference Guide*.

Backing up the cluster configuration data when a floppy disk is not available for use

Do either (1) or (2) depending on the operating system on which you use the Builder. The following example assumes that data is backed up in the /tmp/backup directory.

1. To back up the cluster configuration data for the Builder working on Linux Web browser, run the following command:

```
clpcfctrl --pull -l -x /tmp/backup
```

2. To back up the cluster configuration data for the Builder working on Windows Web browser, run the following command:

```
clpcfctrl --pull -w -x /tmp/backup
```

Related Information:

For details on the clpcfctrl command options, see Chapter 4, “ExpressCluster command reference” in the *Reference Guide*.

Section III Evaluation before operating a cluster system

This section provides information on the evaluation that must be done before starting the operation of ExpressCluster. After you have verified the constructed system, check what you need to do before you start operating a cluster system. This section also provides instructions for uninstallation and reinstallation.

- Chapter 8 Verifying operation
- Chapter 9 Preparing to operate a cluster system
- Chapter 10 Uninstalling and reinstalling ExpressCluster

Chapter 8 Verifying operation

This chapter provides information on how to run dummy-failure tests to see the behaviors of your cluster system and how to adjust parameters.

This chapter covers:

- Operation tests..... 178
- Backup procedures 182
- Restoration 184

Operation tests

Verify how your cluster behaves by performing dummy-failure tests and/or backup restoration of the shared disk. Check for errors in monitor resources or stoppage of the server and OS.

If any error is detected in monitor resources or any stoppage of the server or the OS occurs, the time-out value or other settings need to be adjusted.

1. Dummy-failure of the shared disks

(When the shared disks are RAID-configured and dummy-failure tests can be run)

The test must include error, replacement, and recovery of RAID for a shared disk subsystem.

- Set a dummy-failure to occur on a shared disk.
- Recover RAID from the degenerated state to normal state.

For some shared disks, I/O may temporarily stop or delay when they switch to the degenerated operation or when RAID is reconfigured.

If any time-out and/or delay occurs in disk monitoring, raw monitoring, adjust the time-out value of each monitor resources.

2. Dummy-failure of the paths to shared disks

(When the path to the shared disk is redundant paths and dummy-failure tests can be run.)

The test must include an error in the paths and switching of one path to another.

- Set a dummy-failure to occur in the primary path.

It takes time for some path-switching software (driver) to switch the failed path to the path normally working. In some cases, the control may not be returned to the operating system (software).

If any time-out and/or delay occurs in disk monitoring or raw monitoring, adjust the time-out value of each monitor resources.

3. Backup/Restoration

If you plan to perform regular backups, run a test backup.

Some backup software and archive commands make CPU and/or disk I/O highly loaded.

If any server and/or OS stop, heartbeat delays, delay in monitor resources, or time-out occur, adjust the heartbeat time-out value and/or time-out value of each monitor resources.

Related Information:

For information on how to change each parameter, refer to the *Reference Guide*.

Different types of dummy-failure tests for each device and what happen after the tests are described below:

Device/Resource	Dummy-failure	What happens
Shared disk device SCSI/FC path	Unplug the cable on the server side (for a redundant server, unplug both cables)	When a disk is monitored, failover to the standby server occurs. When no disk is monitored, the operation stops.
		Disk heartbeat resource becomes offline. A warning is issued to the WebManager terminal. = Operation continues.
	For FC, power off the FC-HUB	Disk monitor resources detect an error
		When a disk is monitored, failover to the standby server occurs. When no disk is monitored, the operation stops. Disk heartbeat resources become offline. Disk monitor resources detect an error
Interconnect LAN	Unplug the LAN cable	Communication between servers continues using a public LAN Operation continues
		The LAN heartbeat resource on the interconnect becomes offline. A warning is issued to the WebManager terminal. = Operation continues.
		An error is detected in an IP monitor resource Failover to the standby server occurs.
		An error is detected in a NIC Link Up/Down monitor resource Failover to the standby server occurs.
Public LAN	Unplug the LAN cable or power off the HUB	Communication stops, application stalls or an error occurs. =These do not result in failover.
		LAN heartbeat resource on the public LAN becomes inactive. A warning is issued to the WebManager terminal. = Operation continues.
		An error is detected in an IP monitor resource Failover to the standby server occurs.
		An error is detected in a NIC Link Up/Down monitor resource. Failover to the standby server occurs
UPS	Unplug the UPS from outlet	The active server shuts down Failover to the standby server occurs

Device/Resource	Dummy-failure	What happens
Array UPS	Unplug the UPS from outlet	Both servers shut down Operation stops
LAN for UPS	Unplug the LAN cable	UPS becomes uncontrollable. Operation continues
COM	Unplug the RS-232C cable of the COM heartbeat	COM heartbeat resource becomes offline. A warning is issued to the WebManager terminal. Operation continues.
OS error	Run the shutdown command on the active server	The active server shuts down Failover to a standby server occurs.
Mirror disk connect	Unplug the LAN cable	A warning is issued to the WebManager terminal (mirroring stops) Operation continues, but a switch to a standby server becomes impossible.
		An error is detected in mirror disk monitor resource Operation continues
Disk resource	Start up the group after mounting the disk (Example) # mount /dev/sda2 /mnt/sda2	A disk resource does not get activated. Failover to a standby server occurs.
Exec resource	Write an invalid command in exec resource script Change "EXIT 0" in the end of script to "EXIT 1"	An exec resource does not get activated. Failover to a standby server occurs.
Floating IP address	Specify the already-used address (the one that is used for server) to make it overlapped	A floating IP resource does not get activated.
Virtual IP resource	Specify the already-used address (the one that is used for server) to make it overlapped	A virtual IP resource does not get activated.
Mirror disk resource Hybrid disk resource	Start up the group after mounting the disk (Example) # mount /dev/sda2 /mnt/sda2	A mirror disk resource/hybrid disk resource does not get activated.
NAS resource	Start up the group after mounting the disk (Example) # mount -t nfs server name:/share name /mnt/nas1	A NAS resource does not get activated.
Raw resource	Specify the already-used device (the one that is used for cluster partition) to make it overlapped	A raw resource does not get activated.

Device/Resource	Dummy-failure	What happens
VxVM volume resource	Start up the group after mounting the disk (Example) # mount -t vxfs /dev/sda3 /mnt/sda3	A VxVM volume resource does not get activated.
	Unplug the VxVM disk cable	An error is detected in a VxVM volume monitor resource Operation continues
PID monitor resource	Terminate resident process of monitored exec resource (Example) # kill process ID	Failover to a standby server occurs.
VxVM daemon monitor resource	Stop the VxVM daemon	Failover to a standby server occurs.

Backup procedures

This section explains how to back up and restore the file system. Before you start using your cluster system, make sure to simulate a backup operation. To back up the file system, follow the procedures below.

Backing up while ExpressCluster is active

To back up the file system while the ExpressCluster daemon is active, follow the procedures below.

1. Make sure the cluster is working normally.
2. To prevent the heartbeat time-out caused by highly loaded user space from occurring, change the time-out ratio of ExpressCluster by using the time-out temporary adjustment command.

If you want to triple the current time-out and make this temporary setting valid for one hour, run the following command:

```
# clptoratio -r 3 -t 1h
```

3. Back up the shared disk, mirrored disk or hybrid disk.

For backing up a shared disk, the disk resource in group resources needs to be activated on the server for backup.

For backing up a mirror disk or hybrid disk, the mirror disk resource or hybrid disk resource in group resources needs to be activated on the server for backup. However, a backup command for directly accessing partition devices is not supported for mirror disks and hybrid disk.

4. Set the time-out ratio adjusted with the time-out temporary adjustment command back to the original:

```
# clptoratio -i
```

For details on the command that adjusts time-out temporarily, refer to the *Reference Guide*.

Backing up while ExpressCluster is inactive

To back up the file system while the ExpressCluster daemon is inactive, follow the procedures below.

1. Make sure the cluster is working normally.
2. Stop the ExpressCluster daemon.

```
# clpcl -t -a
```

3. Back up the file system and shared disk.

For the shared disk, manually mount the file system on the shared disk you want to back up. Make sure to unmount the file system after you have completed the backup.

4. Start the ExpressCluster daemon.

```
# clpcl -s -a
```

Backing up while ExpressCluster is inactive ~ For Replicator or Replicator DR ~

It is not recommended to back up the file system while the ExpressCluster daemon is inactive.

For details on emergency backup, see “Mounting mirror disks manually” in Chapter 11, “Trouble shooting” in the *Reference Guide*.

Restoration procedures

You also need to simulate restoration operation before starting to use your cluster system. To restore the file system, follow the procedures below.

Restoring the file system containing the /opt/nec/clusterpro directory

1. Insert a floppy disk into the floppy disk drive of a server normally running in the cluster, and back up the cluster configuration data.

```
# clpcfctrl --pull -l
```

After backing up the data, remove the floppy disk from the floppy disk drive.

Note:

Perform the subsequent procedure on the server to be restored.

2. Run `chkconfig --del name` in the following order to disable services on the server to be restored.

- clusterpro_alertsync
- clusterpro_webmgr
- clusterpro
- clusterpro_md
- clusterpro_trn
- clusterpro_evt

3. Execute cluster shutdown by using Web manager or the `clpstdn` command, and then, restart the server.
4. Restore the file system on the server to be recovered (there is no cluster-dependent work).
5. Verify if the ExpressCluster Server is installed on the restored file system with the following command:

```
rpm -qi expresscls
```

When the ExpressCluster Server is installed, proceed to Step (6).

When the ExpressCluster Server is not installed, proceed to Step (7).

6. If the ExpressCluster Server is installed, run the following command to uninstall it:

```
rpm -e expresscls
```

Note:

Do not specify options other than the one stated above.

For troubleshooting a problem that occurs when you uninstall the ExpressCluster Server, see “Uninstalling the ExpressCluster Server.”

7. Install the ExpressCluster Server.

For details, see “

Setting up the ExpressCluster Server” in Chapter 4 of this guide. If there is any server in the cluster on which an update of the ExpressCluster Server is applied, apply the same update to this server. Make sure that the same version of the ExpressCluster Server is installed on all servers in the cluster.

8. Insert the cluster configuration data floppy disk in the server where the ExpressCluster Server was reinstalled.

Note:

You have to restart the server where the ExpressCluster Server was reinstalled after reinstallation.

9. Register the cluster configuration data which was backed up in Step 1 with the server by running the cluster creation command:

```
# clpcfctrl --push -l
```

```
Command succeeded. (code:0)
```

Verify if the command is successfully displayed and completed.

Related Information:

For details on the cluster creation command, see Chapter 4, “ExpressCluster command reference” in the *Reference Guide*.

10. Remove the floppy disk from the floppy disk drive and restart the server.

Restoring the data on the shared disk

The following describes how to restore the data in the disk resource on the shared disk. If you use a hybrid disk resource for the shared disk, see “Restoring the data on the mirror disk or the hybrid disk.”

Restoring while ExpressCluster is active

1. Make sure that the cluster is working normally.
2. To prevent the heartbeat time-out caused by heavily loaded user space from occurring, change the time-out ratio of ExpressCluster with the time-out temporary adjustment command.

If you want to triple the current time-out and make this temporary setting valid for one hour, run the following command:

```
# clptoratio -r 3 -t 1h
```

3. Restore the shared disk.
The disk resource of the group resource should be active on the server to be restored.
4. Set the time-out ratio adjusted with the timeout temporary adjustment command back to the original ratio:

```
# clptoratio -i
```

Related- Information:

For details on the command for adjusting time-out temporarily, see Chapter 4, “ExpressCluster command reference” in the *Reference Guide*.

Restoring while ExpressCluster is inactive

1. Make sure that the cluster is working normally.
2. Stop the ExpressCluster daemon.

```
# clpcl -t -a
```
3. Run the following command to set the disk resource partition to Read/Write.
For example, when the disk resource partition device is /dev/sdb5:

```
# clproset -w -d /dev/sdb5
```
4. Manually mount the file system on the shared disk to be restored. Make sure to unmount the file system when you have completed restoration.

5. Run the following command to set the disk resource partition to ReadOnly.

For example, when the disk resource partition device is /dev/sdb5:

```
# clproset -o -d /dev/sdb5
```

6. Start the ExpressCluster daemon.

```
# clpcl -s -a
```

Related Information:

For details on the command for operating a cluster, see Chapter 4, “ExpressCluster command reference” in the *Reference Guide*.

Restoring the data on the mirror disk or the hybrid disk

The following describes how to restore the data on the mirrored disk resource or the hybrid disk resource.

Restoring while ExpressCluster is active

1. Make sure that the cluster is working normally.
2. To prevent the heartbeat time-out caused by heavily loaded user space from occurring, change the time-out ratio of ExpressCluster with the time-out temporary adjustment command.

If you want to triple the current time-out and make this temporary setting valid for one hour, run the following command.

```
# clptoratio -r 3 -t 1h
```

3. Restore the mirrored disk or the hybrid disk.

Mirror disk resource or hybrid disk resource of the group resource should be active on the server where you want to restore them.

4. Set the time-out ratio adjusted with the time-out temporary adjustment command back to the original.

```
# clptoratio -i
```

Related Information:

For details on the command for adjusting time-out temporarily, see Chapter 4, “ExpressCluster command reference” in the *Reference Guide*.

Restoring while ExpressCluster is inactive

It is not recommended to restore mirror disk while ExpressCluster is inactive.

Chapter 9 Preparing to operate a cluster system

This chapter describes what you have to do before you start operating a cluster system, such as how you perform operation simulation, backup, data restoration and log collection.

This chapter covers:

- Operating the cluster system..... 190
- Suspending ExpressCluster 191
- Checking the log collecting procedure..... 193

Operating the cluster system

Before you start using your cluster system, check to see your cluster system work properly and make sure you can use the system properly.

The following describes procedures to start up and shut down a cluster and to shut down a server.

Activating a cluster

To activate a cluster, follow the instructions below:

1. When you are using any shared or external mirror disk, start the disk.
2. Start all the servers in the cluster.

Note:

When you start all the servers in the cluster, make sure they are started within the duration of time set to **Server Sync Wait Time** on the **Timeout** tab of the **Cluster Properties** in the Builder. Note that failover occurs if startup of any server fails to be confirmed within the specified time duration.

The shared disk spends a few minutes for initialization after its startup. If a server starts up during the initialization, the shared disk cannot be recognized. Make sure to set servers to start up after the shared disk initialization is completed. For more information, see “Shared disk settings for disk resource (Required for disk resource)” on page 32.

Shutting down a cluster and server

To shut down a cluster or server, use ExpressCluster commands or shut down through the WebManager.

Note:

When you are using the Replicator, mirror break may occur if you do not use any ExpressCluster commands or WebManager to shut down a cluster.

Shutting down the entire cluster

The entire cluster can be shut down by running the `clpstdn` command or executing cluster shutdown from the WebManager. By shutting down a cluster, all servers in the cluster can be stopped properly as a cluster system.

Related Information:

For more information on the `clpstdn` command and the WebManager functions, refer to the *Reference Guide*.

Shutting down a server

Shut down a server by running the `clpdown` command or executing server shutdown from the WebManager.

Failover occurs when you shut down a server. A mirror break occurs as well when you are using the Replicator.

If you intend to use a standby server while performing hardware maintenance, shut down the active server.

Related Information:

For more information on the `clpdown` command and the WebManager functions, refer to the *Reference Guide*.

Suspending ExpressCluster

There are two ways to stop running ExpressCluster. One is to stop the ExpressCluster daemon, and the other is to disable the ExpressCluster daemon.

Stopping the ExpressCluster daemon

To stop only the ExpressCluster daemon without shutting down the operating system, use the `clpcl` command.

Related Information:

For more information on the `clpcl` command, refer to the *Reference Guide*.

Disabling the ExpressCluster daemon

To make the ExpressCluster daemon not start at the time the operating system is started up, you can disable it with the `chkconfig` command. The following describes how to disable the ExpressCluster daemon. To disable the ExpressCluster daemon, you also have to disable the ExpressCluster X WebManager.

Follow the procedures below to disable the ExpressCluster daemon:

1. Run `chkconfig --del name` in the following order to disable services on the server where you want to disable the ExpressCluster daemon.
 - `clusterpro_alertsync`
 - `clusterpro_webmgr`
 - `clusterpro`
 - `clusterpro_md`
2. Execute cluster shutdown by using the Web Manager or the `clpstdn` command, and then, restart the server.

Enabling the disabled ExpressCluster daemon

Follow the procedures below to enable the disabled ExpressCluster daemon again:

1. On the server where the ExpressCluster daemon is disabled, run **chkconfig --add name** in the following order to enable services.
 - clusterpro_md
 - clusterpro
 - clusterpro_webmgr
 - clusterpro_alertsync
2. Restart the server.

Checking the log collecting procedure

The following describes how to collect logs by using the WebManager.

Collecting logs by using the WebManager

1. Start the WebManager.
2. In the title view, click **Collect Logs**. The log collection dialog box will open.

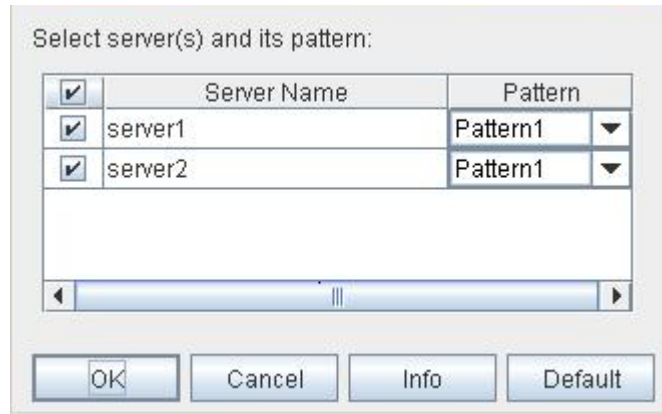

3. Select the check box of the servers for collecting log and select a log collection pattern.
To view details of the pattern, click the **Info** button. To reset the settings, click the **Default** button.
4. Click **OK**. Log collection will start and the dialog box that shows the progress of log collection will open.

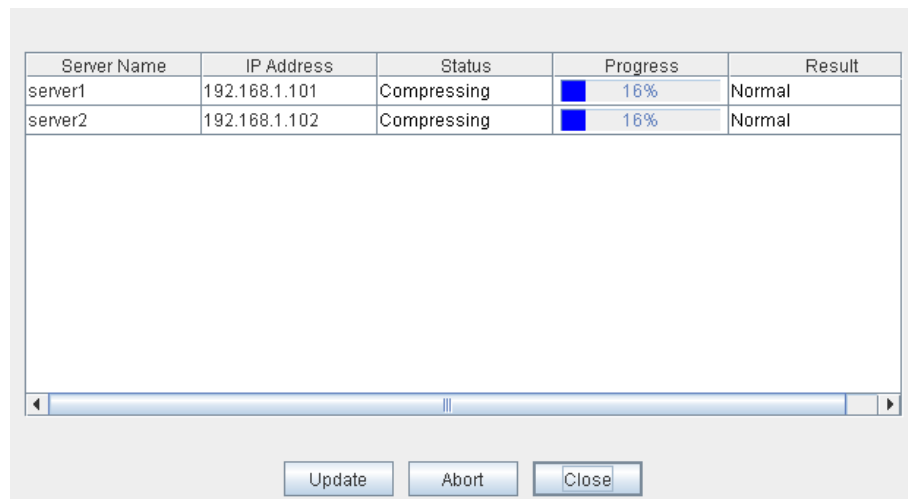

The progress is displayed in the **Progress** column. To view the latest status, click the **Update** button.

5. When log collection is completed, a file saving dialog box of the browser is displayed. Specify a location to store the file and download the logs.

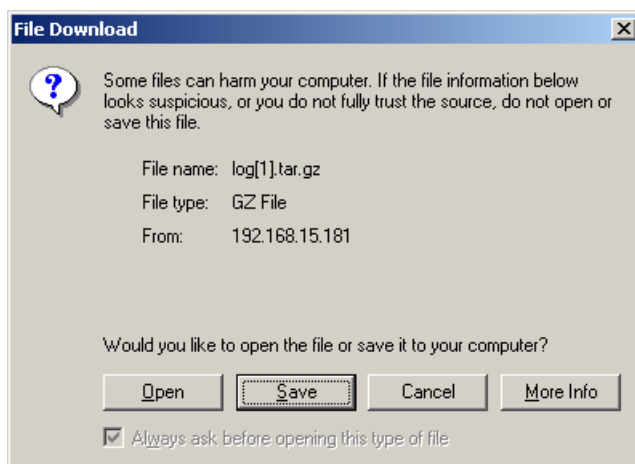

Note:

Logs may not be downloaded properly if nothing is changed for more than 10 minutes.

When you collect logs, the following message may be displayed in the server console. However, this will not affect log collection. Ignore this message.

```
hda: bad special flag: 0x03
ip_tables: (C) 2000-2002 Netfilter core team
```

Note:

If other modal dialog is displayed while collecting logs, the file saving dialog box for the log collection will not be displayed. To display the file saving dialog box, terminate the modal dialog.

Chapter 10 Uninstalling and reinstalling ExpressCluster

This chapter provides instructions for uninstalling and reinstalling ExpressCluster.
This chapter covers:

- Uninstallation 196
- Reinstallation 198

Uninstallation

Uninstalling the ExpressCluster Server

Note:

You must log on as root user when uninstalling the ExpressCluster Server.

Follow the procedures below to uninstall the ExpressCluster Server:

1. Run the `chkconfig --del name` to disable the following services in this order.
 - `clusterpro_alertsync`
 - `clusterpro_webmgr`
 - `clusterpro`
 - `clusterpro_md`
 - `clusterpro_trn`
 - `clusterpro_evt`
 2. Execute the cluster shutdown by using the Web Manager or the `clpstdn` command, and then, perform restart.
 3. Run the `rpm -e expresscls` command.
-

Note:

Do not specify other options than the one stated above.

Deleting the Java user policy file of ExpressCluster X Builder (Online version)

Follow the procedures below to delete the Java user policy file setting.

1. Delete a .java.policy file added to the home directory when installing the ExpressCluster X Builder. For details on how to set up a .java.policy file, see “Creating the cluster configuration data using the Builder” in Chapter 5 “Creating the cluster configuration data using the Builder.”

Uninstalling the ExpressCluster X Builder (Offline version)

For Linux

Note:

You must log on as root user when uninstalling the ExpressCluster X Builder.

Follow the procedures below to uninstall the ExpressCluster X Builder:

1. Close all Web browsers.
2. Run the `rpm -e expressclsbuilder` command.

Note:

Do not specify other options than the one stated above.

3. Delete Java user policy file settings.
Delete the ExpressCluster X Builder settings, which were added at installation, from the .java.policy file in the home directory. For details on the ExpressCluster X Builder settings, see “Installing the Builder on a Linux machine (Offline version)” in Chapter 5.

For Windows

To uninstall the ExpressCluster X Builder, follow the procedures below:

1. Exit from all Web browsers (confirm that the JavaVM icon is no longer in the task tray).
2. Delete the ExpressCluster X Builder installation folder from Windows Explorer.
3. Delete Java user policy file settings.
Delete ExpressCluster X Builder settings, which were added at installation, from the .java.policy file in the home directory. For details on ExpressCluster X Builder settings, refer to Chapter 3, “Functions of the Builder” in the *Reference Guide*.

Reinstallation

Reinstalling the ExpressCluster Server

To reinstall the ExpressCluster Server, you have to prepare the cluster configuration data floppy disk (or the latest data floppy disk if you reconfigured the cluster) created by the Builder.

If you do not have the cluster configuration data floppy disk (or the latest data floppy disk if you reconfigured the cluster) created by the Builder at hand, you can back up the data with the `clpcfctrl` command. For details, see Chapter 4, “ExpressCluster command reference” in the *Reference Guide*.

To reinstall ExpressCluster Server on the entire cluster

To reinstall the ExpressCluster Server, follow the procedures below:

1. Uninstall the ExpressCluster Server.
For details, see “Uninstalling the ExpressCluster Server.”
2. Install the ExpressCluster Server and recreate the cluster.
For details, see “
3. Setting up the ExpressCluster Server.”

To reinstall ExpressCluster Server on some servers in the cluster

To reinstall the ExpressCluster X, follow the procedures below:

1. Uninstall the ExpressCluster Server.
For details, refer to “Uninstalling the ExpressCluster Server.”
2. Install the ExpressCluster Server RPM.
For details, refer to “Installing the ExpressCluster RPM.”

Note:

You have to restart the server on which you reinstalled the ExpressCluster Server.

3. Distribute the configuration data to servers of which the ExpressCluster Server has been reinstalled from the server where it has not been reinstalled. Log on to one of the server where the ExpressCluster Server has not been reinstalled. Run one of the following commands:

- ◆ `clpcfctrl --push -h`
`<Host_name_of_a_server_where_the_ExpressCluster_Server_was_reinstalled>`
- ◆ `clpcfctrl --push -h`
`<IP_address_of_a_server_where_the_ExpressCluster_Server_was_reinstalled>`

The following message is displayed if the data has successfully been distributed.

Command succeeded.(code:0)

Note:

For troubleshooting problems that occur while you are running `clpcfctrl`, refer to the *Reference Guide*.

4. If mirror resources are configured on the distributed configuration data, initializing the device specified as a cluster partition of mirror resources is required. Run the `clpmdinit` command to initialize it. For details, see Chapter4 “ExpressCluster command reference” in the *Reference Guide*.
5. Register the license only if the option of the node license will be used on the server where the ExpressCluster Server is reinstalled. For more information, refer to “Registering the node license.”

6. Restart the server on which you reinstalled the ExpressCluster Server.

Appendix A. Troubleshooting

Errors messages when installing the ExpressCluster X Builder

	Error message	Cause	Action
1	failed to open //var/lib/rpm/packages.rpm error: cannot open //var/lib/rpm/packages.rpm	The user logged on is not root user.	Log on as root user.
2	error: package expressclsbuilder-* is already installed	The ExpressCluster X Builder is already installed.	Uninstall the Builder and reinstall it.

Error messages when uninstalling the ExpressCluster X Builder

	Error messages	Cause	Action
1	failed to open //var/lib/rpm/packages.rpm error: cannot open //var/lib/rpm/packages.rpm	The user logged on is not root user.	Log on as root user.
2	error: Cluster Builder is running	The ExpressCluster X Builder is active.	Exit from the Web browser. Uninstall it again after waiting for a while.

Error messages when installing the ExpressCluster Server

	Error message	Cause	Action
1	failed to open //var/lib/rpm/packages.rpm error: cannot open //var/lib/rpm/packages.rpm	The user logged on is not root user.	Log on as root user.
2	error: package expresscls-* is already installed	The ExpressCluster is already installed.	Uninstall the Builder and reinstall it.
3	warning: EXPRESSCLUSTER : The mirror driver is not supported this distribution.	The mirror driver does not support the distribution of a server where ExpressCluster is installed.	The mirror disk resource does not run on the distribution the mirror driver does not support.
4	warning: EXPRESSCLUSTER : The khb driver is not supported this distribution.	The clpkhb driver does not support the distribution of a server where ExpressCluster is installed.	The kernel mode LAN heartbeat does not run on the distribution the clpkhb does not support.
5	warning: EXPRESSCLUSTER : The ka driver is not supported this distribution.	The clpka driver does not support the distribution of a server where ExpressCluster is installed.	The module which uses the clpka driver does not run on the distribution the clpka does not support.

Error messages when uninstalling the ExpressCluster Server

	Error messages	Cause	Action
1	failed to open //var/lib/rpm/packages.rpm error: cannot open //var/lib/rpm/packages.rpm	The user logged on is not root user.	Log on as root user.
2	error: EXPRESSCLUSTER is running	The ExpressCluster is active.	Disable services by using the chkconfig command, restart the server, and uninstall the ExpressCluster again.

Troubleshooting for licensing

Behavior and Message	Cause	Action
When the command was executed, the following message appeared in the console: "Log in as root."	The command was executed by a general user.	Log on as root user or log on again after changing to root user with su -.
When the command was executed at the license registration, the following message appeared in the console: "Command succeeded. But the license was not applied to all the servers in the cluster because there are one or more servers that are not started up."	The transaction server may not be active, or the cluster configuration data may be yet to be distributed.	Check again whether the transaction server is activated and the cluster configuration data is distributed on all servers. If either of them is not done yet, complete the task and register the license again.
When the cluster was shut down and rebooted after distribution of the configuration data created by the Builder to all servers, the following message was displayed on the WebManager's alert view, and the cluster stopped. "The license is not registered. (%1)" %1: Product ID	The cluster has been shut down and rebooted without its license being registered.	Register the license from one of the servers in the cluster.
When the cluster was shut down and rebooted after distribution of the configuration data created by the Builder to all servers, the following message appeared on WebManager's alert view, but the cluster is working properly. "The license is insufficient. The number of insufficient is %1. (%2)" %1: The number of licenses in short of supply %2: Product ID	The number of licenses is insufficient.	Obtain a license and register it.
While the cluster was operated on the trial license, the following message appeared and the cluster	The license has already expired.	Ask your sales agent for extension of the trial version license,

stopped. "The license of trial expired by %1. (%2)" %1: Trial end date %2: Product ID		or obtain and register the product version license.
---	--	---

Appendix B. Glossary

Cluster partition	A partition on a mirror disk. Used for managing mirror disks. (Related term: Disk heartbeat partition)
Interconnect	A dedicated communication path for server-to-server communication in a cluster. (Related terms: Private LAN, Public LAN)
Virtual IP address	IP address used to configure a remote cluster.
Management client	Any machine that uses the WebManager to access and manage a cluster system.
Startup attribute	A failover group attribute that determines whether a failover group should be started up automatically or manually when a cluster is started.
Shared disk	A disk that multiple servers can access.
Shared disk type cluster	A cluster system that uses one or more shared disks.
Switchable partition	A disk partition connected to multiple computers and is switchable among computers. (Related terms: Disk heartbeat partition)
Cluster system	Multiple computers are connected via a LAN (or other network) and behave as if it were a single system.
Cluster shutdown	To shut down an entire cluster system (all servers that configure a cluster system).
Active server	A server that is running for an application set. (Related term: Standby server)
Secondary server	A destination server where a failover group fails over to during normal operations. (Related term: Primary server)
Standby server	A server that is not an active server. (Related term: Active server)
Disk heartbeat partition	A partition used for heartbeat communication in a shared disk type cluster.
Data partition	A local disk that can be used as a shared disk for switchable partition. Data partition for mirror disks or hybrid disks. (Related term: Cluster partition)
Network partition	All heartbeat is lost and the network between servers is partitioned. (Related terms: Interconnect, Heartbeat)

Node	A server that is part of a cluster in a cluster system. In networking terminology, it refers to devices, including computers and routers, that can transmit, receive, or process signals.
Heartbeat	Signals that servers in a cluster send to each other to detect a failure in a cluster. (Related terms: Interconnect, Network partition)
Public LAN	A communication channel between clients and servers. (Related terms: Interconnect, Private LAN)
Failover	The process of a standby server taking over the group of resources that the active server previously was handling due to error detection.
Failback	A process of returning an application back to an active server after an application fails over to another server.
Failover group	A group of cluster resources and attributes required to execute an application.
Moving failover group	Moving an application from an active server to a standby server by a user.
Failover policy	A priority list of servers that a group can fail over to.
Private LAN	LAN in which only servers configured in a clustered system are connected. (Related terms: Interconnect, Public LAN)
Primary (server)	A server that is the main server for a failover group. (Related term: Secondary server)
Floating IP address	Clients can transparently switch one server from another when a failover occurs. Any unassigned IP address that has the same network address that a cluster server belongs to can be used as a floating address.
Master server	The server displayed on top of the Master Server in Cluster Properties in the Builder.
Mirror disk connect	LAN used for data mirroring in mirror disk or hybrid disk. Mirror connect can be used with primary interconnect.
Mirror disk type cluster	A cluster system that does not use a shared disk. Local disks of the servers are mirrored.

Appendix C. Index

A

- Activating a cluster, 190
- Add a cluster, 90, 109, 132
- Add a group, 163
- Add a group for management, 95, 115, 141
- Add a group for operation, 97, 117, 143
- Add a group for operation 2, 119
- Add a group resource, 97, 98, 144, 145
- Add a group resource (exec resource), 118, 121
- Add a group resource (floating IP address), 117, 120, 163
- Add a group resource (mirror disk resource), 118, 121
- Add a monitor resource, 163
- Add a monitor resource (disk monitor), 147
- Add a monitor resource (NIC Link Up/Down monitor for management group), 147
- Add a monitor resource (NIC Link Up/Down monitor resource for management group), 123, 147
- Add a monitor resource (NIC Link Up/Down monitor resource for operation 1), 124
- Add a monitor resource (NIC Link Up/Down monitor resource for operation 2), 124
- Add a monitor resource (raw monitor resource), 123
- Add a monitor resources, 147
- Add the first server, 91, 109, 133
- Add the second server, 93, 112, 135
- Add the server, 162
- Add the third server, 113, 137
- Adjustment of the operating system startup time, 39
- applications to be duplicated, 50

B

- Backing up, 182, 183
- Backing up the cluster configuration data, 172, 173
- Backup procedures, 182
- Browsers supported, 82

C

- Checking system requirements for each ExpressCluster module, 26
- Checking system requirements for the Builder, 29
- Checking the values to be configured, 79, 85, 102, 126
- cluster topology, 47
- Collecting logs by using the WebManager, 193
- Configuring a cluster system, 46
- Create a failover group, 95, 115, 141
- Creating a cluster, 90, 109, 132, 154
- Creating monitor resources, 100, 123

- Creating the cluster configuration data, 80, 89, 107

D

- data mirror type, 19
- Deleting the Java user policy file of ExpressCluster X Builder, 197
- disabled, 192
- Disabling, 191

E

- ExpressCluster daemon, 191
- ExpressCluster X WebManager, 81

F

- Failover in multi-directional standby cluster, 49
- Failover in uni-directional standby cluster, 48
- file system, 184

G

- group resources, 55

H

- hardware configuration, 28, 31
- heartbeat resources, 58
- How to create a cluster, 154

I

- Installing the Builder on a Linux machine, 66, 197
- Installing the Builder on a Windows machine, 67
- Installing the ExpressCluster GAIA RPM, 65

L

- log collecting, 189, 193

M

- Modifying the cluster configuration data, 162, 163, 164
- modules, 18
- monitor resources, 56

N

- Notes, 171
- Notes for using the offline Builder, 171

O

- Offline version Builder, 167

Online version Builder, 166
Operating the cluster system, 190
Operation tests, 178

P

Partition settings for hybrid disk resource, 38
Partition settings for mirror disk resource, 36
Planning a cluster configuration, 54

R

Reflecting the cluster configuration data, 165
Registering the CPU license, 69, 70
Registering the license by specifying the license file, 70, 71
Registering the license interactively from the command line, 70, 72
Registering the node license, 74
Registering the node license by specifying the license file, 74
Registering the node license interactively from the command line, 74, 76
Reinstallation, 198
Reinstalling the ExpressCluster Server, 198
Restoration procedures, 184
Restoring the data on the mirror disk or the hybrid disk, 187
Restoring the data on the shared disk, 186

S

Sample cluster environment, 85
Saving the cluster configuration data, 150
Saving the cluster configuration data in the file system, 150, 151
Saving the cluster configuration data on a floppy disk, 152, 153
Server applications, 50
Server clock synchronization, 44
Setting Up JAVA runtime environment, 83
Settings after configuring hardware, 32
Shared disk settings for disk resource, 32, 190
Shared disk settings for hybrid disk resource, 34
Shared disk type, 19
Shutting down a cluster and server, 190
Shutting down a server, 190

Shutting down and restarting a cluster after uploading data, 166, 169
Shutting down the entire cluster, 190
Starting the Builder, 68, 84
Starting the WebManager, 83
Starting up the ExpressCluster X WebManager, 81
Suspending, 189, 191
system configuration, 19

T

Troubleshooting, 201

U

Understanding network partition resolution resources, 59
Uninstallation, 196
Uninstalling the ExpressCluster Server, 184, 196, 198
Uninstalling the ExpressCluster X Builder, 197
Uploading data after stopping a cluster, 166, 168
Uploading data after stopping mirror agents, 167, 170
Uploading data after suspending a cluster, 166, 168
Uploading data and restarting the WebManager, 166, 167
Uploading data only, 166, 167
Uploading the cluster configuration data, 171, 173

V

Verification of the firewall settings, 42
Verification of the network settings, 41
Verification of the root file system, 41
Verifying cluster using the WebManager, 156
Verifying operation by using commands, 158
Verifying system requirements for the WebManager, 30

W

What is ExpressCluster, 15, 17